



GUIDELINES FOR RECORDING HISTORIC SHIPS

Third Edition: 2004

HISTORIC AMERICAN BUILDINGS SURVEY
HISTORIC AMERICAN ENGINEERING RECORD
HISTORIC AMERICAN LANDSCAPES SURVEY



NATIONAL PARK SERVICE, U.S. DEPARTMENT OF THE INTERIOR

LEGISLATIVE AUTHORITY FOR HABS/HAER/HALS AND THE USE OF OTHER GUIDELINES

The legislative authority of HABS/HAER/HALS is the 1935 Historic Sites Act (Public Law 74-292) and the 1966 National Historic Preservation Act (Public Law 89-665), as amended in 1980 (Public Law 96-515).

The guidelines should be used in conjunction with:

- *Secretary of the Interior's Standards and Guidelines for Architectural and Engineering Documentation* as published in the Federal Register, Vol. 48, No. 190, Notices, pp. 44730-44734, generally known as HABS/HAER Standards.
- *Recording Historic Structures*. John A. Burns, editor. Washington, D.C.: The AIA Press, 1989
- HABS/HAER Guidelines:
 - *HABS Historical Reports*
 - *HABS/HAER Guidelines: Recording Structures with HABS Measured Drawings* (1995)
 - *Historic American Engineering Record Field Instructions* (1995)

Transmitting HABS/HAER Documentation

Historic American Buildings Survey/Historic American Engineering Record/Historic American Landscapes Survey, National Park Service
U.S. Department of the Interior
1849 C Street, NW - 2270
Washington, DC 20240
(202) 354-2167

First edition, September 1988.
Second edition, September 1994.
Third edition, January 2004.

Cover:
Inboard Profile
Ship BALCLUTHA, San Francisco, California
HAER No. CA-54

Reduced from portion of original 3/8" scale drawing
delineated by Robbyn L. Jackson and Deborah J. Cooper, 1987.

National Park Service
U.S. Department of the Interior



GUIDELINES FOR RECORDING HISTORIC SHIPS

RICHARD K. ANDERSON, JR.

**THIRD EDITION
2004**

EDITED BY TODD A. CROTEAU

HISTORIC AMERICAN BUILDINGS SURVEY
HISTORIC AMERICAN ENGINEERING RECORD
HISTORIC AMERICAN LANDSCAPES SURVEY

NATIONAL PARK SERVICE
U.S. DEPARTMENT OF THE INTERIOR
WASHINGTON, D.C.

CONTENTS

Section 1: INTRODUCTION

- 1.1 Preface
- 1.2 Acknowledgements

Section 2: HISTORY

- 2.1 Historical Report Guidelines
- 2.2 Historical Reports
- 2.3 General Bibliography
- 2.4 Case Study

Section 3: PHOTOGRAPHY

- 3.1 Photography Guidelines
- 3.2 Large-format Photography for Historic Ships
- 3.3 Preparation of Photographs for Transmittal to the Library of Congress

Section 4: MEASURED DRAWINGS

- 4.1 Measured Drawings Guidelines
- 4.2 What's Involved
- 4.3 Field Methods
- 4.4 Field Notes
- 4.5 Field Photographs
- 4.6 Measured Drawings
- 4.7 Drawing Examples
- 4.8 References and Resources
- 4.9 Appendices

Section 5: FIELD REPORTS

- 5.1 What to Consider

Section 6: USING THE COLLECTION

LEGISLATIVE AUTHORITY FOR HABS/HAER/HALS AND THE USE OF OTHER GUIDELINES

The legislative authority of HABS/HAER/HALS is the 1935 Historic Sites Act (Public Law 74-292) and the 1966 National Historic Preservation Act (Public Law 89-665), as amended in 1980 (Public Law 96-515).

The guidelines should be used in conjunction with:

- *Secretary of the Interior's Standards and Guidelines for Architectural and Engineering Documentation* as published in the Federal Register, Vol. 48, No. 190, Notices, pp. 44730-44734, generally known as HABS/HAER Standards.
- *Recording Historic Structures*. John A. Burns, editor. Washington, D.C.: The AIA Press, 1989
- HABS/HAER Guidelines:
 - *HABS Historical Reports*
 - *HABS/HAER Guidelines: Recording Structures with HABS Measured Drawings* (1995)
 - *Historic American Engineering Record Field Instructions* (1995)

Transmitting HABS/HAER Documentation

Historic American Buildings Survey/Historic American Engineering Record/Historic American Landscapes Survey, National Park Service
U.S. Department of the Interior
1849 C Street, NW - 2270
Washington, DC 20240
(202) 354-2167

First edition, September 1988.
Second edition, September 1994.
Third edition, January 2004.

Cover:
Inboard Profile
Ship BALCLUTHA, San Francisco, California
HAER No. CA-54

Reduced from portion of original 3/8" scale drawing
delineated by Robbyn L. Jackson and Deborah J. Cooper, 1987.

National Park Service
U.S. Department of the Interior



GUIDELINES FOR RECORDING HISTORIC SHIPS

RICHARD K. ANDERSON, JR.

**THIRD EDITION
2004**

EDITED BY TODD A. CROTEAU

HISTORIC AMERICAN BUILDINGS SURVEY
HISTORIC AMERICAN ENGINEERING RECORD
HISTORIC AMERICAN LANDSCAPES SURVEY

NATIONAL PARK SERVICE
U.S. DEPARTMENT OF THE INTERIOR
WASHINGTON, D.C.

CONTENTS

Section 1: INTRODUCTION

- 1.1 Preface
- 1.2 Acknowledgements

Section 2: HISTORY

- 2.1 Historical Report Guidelines
- 2.2 Historical Reports
- 2.3 General Bibliography
- 2.4 Case Study

Section 3: PHOTOGRAPHY

- 3.1 Photography Guidelines
- 3.2 Large-format Photography for Historic Ships
- 3.3 Preparation of Photographs for Transmittal to the Library of Congress

Section 4: MEASURED DRAWINGS

- 4.1 Measured Drawings Guidelines
- 4.2 What's Involved
- 4.3 Field Methods
- 4.4 Field Notes
- 4.5 Field Photographs
- 4.6 Measured Drawings
- 4.7 Drawing Examples
- 4.8 References and Resources
- 4.9 Appendices

Section 5: FIELD REPORTS

- 5.1 What to Consider

Section 6: USING THE COLLECTION

Section 1

INTRODUCTION

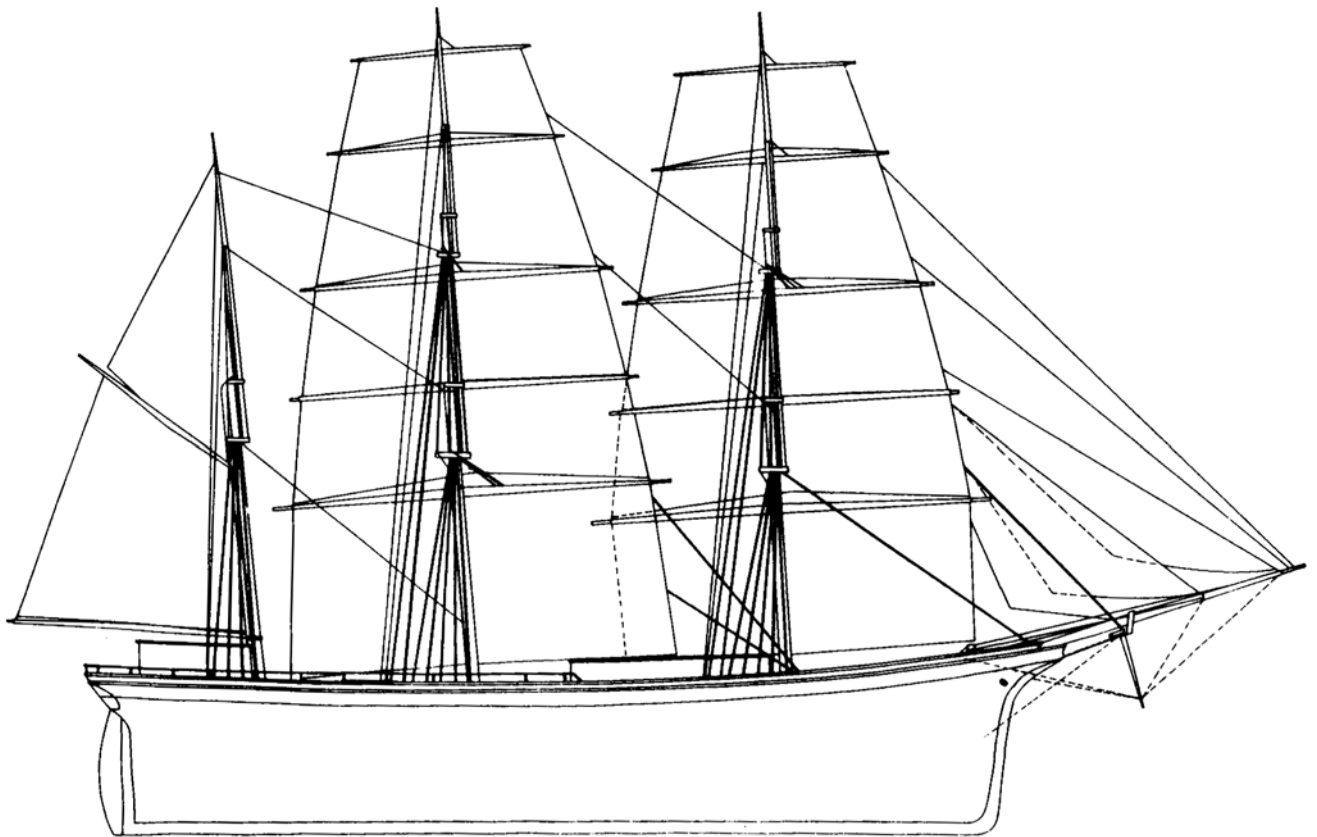

PREFACE

Background. Nation-wide interest in maritime history and the preservation or replication of large historic ships has grown substantially in recent years. It has become apparent that physical preservation of vessels will not be feasible in a large number of cases, and that documentation--preservation "on paper"--will prove to be the most reasonable preservation method available. Where physical preservation of a ship *is* undertaken, in most cases detailed documentation must be made before stabilization, repairs, or other preservation measures can be safely undertaken. Such documentation is also a form of insurance against partial or total loss of a significant vessel to posterity should some catastrophe occur to the vessel itself.

Americans have always held an interest in their maritime history; however, efforts to preserve its largest *physical* expression--the ships--have lagged behind preservation of small craft, artifacts, written historical documents, and folklore, with only a few important exceptions. Led by the private and public sectors since the 1960s, the national movement to preserve historic buildings has encouraged a similar movement in maritime history on local and national levels. The impetus for the following HAER guidelines lies with the Standards Committee of the National Maritime Heritage Task Force which met between September 1982 and December 1983 under the auspices of the National Trust for Historic Preservation. The HAER guidelines were one of several related documents prepared in response to a 1985 congressional mandate to "inventory maritime resources, recommend standards for their preservation, and recommend private and public sector roles for that preservation." Vigorous discussion among American maritime museums, professionals, interest groups, and the National Park Service ensued in meeting the goals of this

mandate. A national inventory of preserved historic vessels over 40 feet long was completed by the National Park Service, with the cooperation of numerous agencies and museums. In 1987, the National Register of Historic Places published specific instructions for nominating vessels to the National Register (*Bulletin #20: Nominating Historic Vessels and Shipwrecks to the National Register of Historic Places*). The Historic American Engineering Record produced the *Guidelines for Recording Historic Ships* in 1988 in accordance with the established *Secretary of the Interior's Standards for Architectural and Engineering Documentation*. The Museum Small Craft Association began development of guidelines for documentation of historic small craft in 1988; *Boats: A Manual for Their Documentation* was published in 1994 by the American Association for State and Local History. In 1990 the Maritime Preservation Program within the National Park Service published the *Secretary of the Interior's Standards for Historic Vessel Preservation Projects* and *1990 Inventory of Large Preserved Historic Vessels*. Many of these publications were to form a part of the National Trust's planned Manual for the Documentation of Historic Maritime Resources, which was to have included guidelines for documenting all types of maritime-related tangible and intangible resources. The Department of Maritime Preservation in the National Trust was disbanded in 1993, and this publication was not issued.

The Historic American Engineering Record (HAER). The documentation of historic ships has a long history reflecting the influence of numerous motives, traditions, and important individual authorities. The Historic American Engineering Record was established in the National Park Service in 1969 to create a public record of the United States' engineering and industrial patrimony. It is the companion program to the widely known Historic American Buildings Survey (HABS), founded in 1933 to

record historic architecture in the United States. A new sibling to HABS and HAER, the Historic American Landscapes Survey (HALS) was established in 2000 to focus on documenting designed or evolved landscapes. At its fullest, HAER documentation consists of three components--fully footnoted investigative histories, large-format photography, and detailed measured drawings. Each component has inherent strengths the others lack, so that an integrated "package" focused on a specific site or ship becomes a powerful documentary tool; the ship itself is examined and treated as a document every bit as important as historical records. Since all documentary efforts are necessarily selective and interpretive, the HAER guidelines help to elicit and capture the significant aspects of each vessel and present them as clearly as possible. The final records are produced on archival materials having a 500-year lifespan and are deposited in the HAER collection at the Prints and Photographs Division of the Library of Congress.

Access to HAER Records. HAER records are in the public domain and are open for public access. They may be copied and used for any purpose, with proper credit given to HAER and the National Park Service, as well as the delineator, photographer, or historian. The collection can be searched and viewed online at the Library of Congress web site http://memory.loc.gov/ammem/collections/habs_haer/ at:

Microfilm copies of the HAER collection are available at more than 110 libraries and institutions throughout the United States. For further information, write to the HAER Reference Librarian, Prints and Photographs Division, Library of Congress, Washington, DC 20540.

Standards and Guidelines. In order to insure a uniform quality of content and presentation, the *Secretary of the Interior's Standards for Architectural and Engineering Documentation* govern preparation of documents for inclusion in the HABS and HAER collections; they are

reproduced for reference in Section 4.9. In order to make the kind and quantity of documentation appropriate to the significance of a vessel, four levels of effort are outlined in the standards. The maritime guidelines presented here interpret the first three levels of the standards (Levels I - III) for use in producing documentation acceptable to the HAER collection. The fourth level, an inventory or survey card was recently discontinued, however, a survey can be formatted to a *Historic Report* template.

HAER has attempted to base these guidelines on the best of widely accepted, established professional practices in historical research, vessel documentation and measurement, industrial archeology, documentary photography, and measured drawings. The guidelines are not meant to be the final authority, which all recorders must accept regardless of affiliation or before which all previous methods and products are to be seen as inferior. HAER has attempted to draw on the tremendous wealth of previous examples and to make the guidelines as flexible and broadly applicable as possible. HAER anticipates their acceptance by a wide range of authorities and users, and trusts that they will prove useful for non-HAER documentation projects.

Emphases. HAER documentation is vessel-specific, and records should reflect what is significant about the vessel. Where design is important--as it is expected to be in the majority of cases--hull shape and/or vessel construction and propulsion should be highlighted as significance dictates. Measured drawings may not be required in some cases, since significance may inhere in some nondesign facts, such as historical events or associations with important persons. Existing drawings and records may also be sufficient to document historic conditions. The HAER collection at the Library of Congress does not accept pre-existing or original materials (except as photocopies), but recognizes their great value and strongly encourages their preservation by responsible repositories.

In documenting ships, HAER intends to build on the work of the Historic American Merchant

Marine Survey (HAMMS), a 14-month program administered from 1936 to 1937 by the Smithsonian Institution as part of the Works Progress Administration. HAMMS put naval architects and others idled by the Great Depression to work making records of vanishing historic vessels with the intention of providing future naval architects a useful base-line record of American ship design evolution. For its time, it was a monumental effort, and deserves great credit. Of the 426 vessels included in the survey, only one survived in 1988. (The HAMMS Collection is located in the Division of Transportation, National Museum of American History, Smithsonian Institution, Washington, DC 20560. Selected HAMMS drawings were reproduced full-size and published in seven volumes by the Ayer Company of Salem, New Hampshire in 1983; see Section 4.7 for a complete citation.) HAMMS surveys worked from half-models and old drawings as well as extant vessels, and the records vary widely in quality due to the varied skills of HAMMS recorders and the frequent lack of convenient, adequate project verification data in the Survey drawings. Some of the Survey's weaknesses are undoubtedly due to its very short lifespan and consequent lack of time to refine and stabilize its methodology. The HAER program benefits from a much longer track record and from further developments in general professional standards of documentation and material culture studies. The user should be able to evaluate HAER records more easily and use them with greater confidence since the methods, bases, and limitations of each project will be more clearly stated. A significant review and evaluation of HAMMS was made in 1986 by James P. Warren (cited in Section 4.7, References and Resources). Since the close of HAMMS, hundreds of historic vessels have disappeared without adequate documentation. It is hoped that the HAER program will help prevent similar losses, and in many cases be a prelude to the physical preservation of many worthy vessels for posterity.

Scope of HAER Maritime Documentation.

HAER documentation should focus on large vessels of national significance as determined by

national inventories, other suitable research, or designation by the Secretary of the Interior as National Historic Landmarks. This scope includes significant survivors of regional and local vessel design. *Bulletin #20* from the National Register of Historic Places provides guidance in determining a vessel's significance.

Vessel Size. In general, HAER documentation focuses on vessels more than 30 feet in length that are floating, or in some manner laid up out of water (e.g. in a dry dock, on a marine railway, as hulks on a beach, etc.). Half-models may also be considered. While documentation of small craft is encouraged and is not excluded from the HAER collection, HAER concentrates on the documentation of larger vessels, principally because they are more susceptible to loss. Small craft--vessels less than 30 feet long--tend to find their way into museums or other protective care more often than larger vessels.

Archeology. The scope of these guidelines briefly includes archeological sites, whether underwater or underground. HAER is generally interested in substantially intact hulks, whether sunk, buried or beached, *and for which contemporary documentary sources (records, photographs, etc.) can be found.* Prehistoric vessels by their very nature have no contemporary written, photographic, or other graphic records to aid in understanding them, hence the approach to recording and interpreting them is considerably different. Professional standards and guidelines already exist for archeological work of this type. Contrary to the expectations of HAER in 1988, the *Guidelines for Recording Historic Ships* have been sought by nautical archeologists for use in underwater documentation of historic vessels. While not originally intended for this purpose, the guidelines have helped fill an apparent gap in archeological guidelines as the field of nautical archeology continues to develop.

Military Vessels. Though documentation of military vessels is in no way excluded from the HAER collection, documentation of 20th-century warships is not specifically addressed in the HAER guidelines. This is

largely due to warships' enormous complexity and the survival of voluminous materials (drawings, records, histories, photographs) in the National Archives, U.S. Navy archives and other repositories. Numerous historical and technical publications for both professionals and laymen are available on this subject. *Recording Structures and Sites for the Historic American Engineering Record* (formerly the HAER *Field Instructions* manual) for recording land-based industrial sites will be of aid in documenting propulsion plants, armament, and other machinery. HAER should be contacted for guidance, as well as other authorities, if a warship is to be recorded for HAER.

Marine Industrial Complexes. Land-based, maritime-related sites can be documented for HAER using *Recording Structures and Sites for the Historic American Engineering Record* mentioned above. Look for HALS guidelines to assist with recording historic maritime-related landscapes.

HAER Project Parameters. HAER usually records a site or vessel as it exists at a specific time, not as an ongoing process. Preserved vessels undergo maintenance, repairs, restorations, and other changes which themselves should be documented, but this kind of ongoing effort is not in HAER's purview. The guidelines are useful, however, for helping establish ongoing documentation programs where they do not now exist by providing a baseline set of records for directing and documenting maintenance, repairs, and restorations.

Project Duration. The average documentation project conducted by HAER runs for 12 weeks during the summer. Some vessels may require two or more successive summers to document, most often due to funding limitations or the need to keep the number of recording team personnel down to a manageable size. Documentation projects conducted for HAER under other auspices are not subject to this schedule.

Reconstructions, Reproductions and Replicas of Vessels. Level I HAER documentation can be used as *baseline* information for building reconstructions or reproductions of historic vessels, however, it should not be construed thereby that HAER documentation, such as a set of measured drawings, is intended to be *sufficient* for such projects. The *Secretary of the Interior's Standards for Historic Vessel Preservation Projects* define "reconstruction", "reproduction" and replication as follows:

Reconstruction: (1) the act or process of creating by new construction accurate form and detail of a particular vessel as it appeared at a specific period of time; (2) a vessel, or part thereof, that is the product of such a process.

Reproduction: When applied to a vessel, the term "reproduction" or "replica," denotes: (1) the act or process of recreating by new construction the general form and appearance of a particular vessel or type of vessel; or (2) a vessel that is the product of such a process.

The *Secretary of the Interior's Standards for Architectural and Engineering Documentation* require HAER records to "adequately explicate and illustrate what is significant or valuable" about a historic vessel, but this does not necessarily mean the drawings, photographs, and written data will allow a shipbuilder to build a replica without supplementary material. HAER records show a user "what was there" *in relation to its historically significant features*. Recording the *historically significant* aspects of a vessel rarely requires that every piece of equipment be recorded down to the smallest detail. Most historic vessels include relatively insignificant details which do not receive coverage. HAER measured drawings should be accurately scaled views, but they are not intended to be "working" or "shop drawings." Old shop drawings of

historic vessel construction are invaluable as records, but production of new ones is in most cases not justifiable unless an actual replication project is imminent. The distinction between a HAER measured drawing and a shop drawing is slight for small wooden sailing vessels of straightforward construction, such as a catboat; several measured drawings and a set of informative photographs may be all a wooden shipbuilder working in a craft tradition will need to construct a replica. HAER's focus is, however, primarily on *large* vessels, many with complex mechanical systems. Construction of a steam-propelled tug boat replica in a modern yard may require several hundred sheets of shop drawings to permit manufacture of hull, structural systems and details, all parts and assemblies for propulsion equipment, auxiliaries, piping, electrical equipment, etc. In documenting a historic tug boat, HAER will not, for example, produce a new drawing of a marine engine crankshaft--complete with dimensions, tolerances, finishes, and specifications for metal alloys--suitable for handing to a machine shop for production of a new part. However, an existing historic shop drawing should be photocopied by HAER if that crankshaft represented a significant advance in the history of marine engine technology. Though the HAER collection does not accept original historic records, existing shop drawings for historic vessels are invaluable and ought to be properly conserved and protected by their owners, or turned over to a responsible archive. Old drawings, photos, and records offer significant insights into history, construction, technology, design, and other factors, and they can be significant time savers in producing HAER drawings. They will also be vital to any restoration or replication efforts. HAER data should indicate where such historic materials can be located. Otherwise, HAER drawings and field notes should form an information base from which a team of qualified naval architects, marine engineers, shipwrights, and others can generate shop drawings for manufacturing purposes; production and curation of shop drawings themselves is beyond HAER's mission.

Users of the Guidelines. The HAER guidelines are written primarily for use under HAER supervision by HAER summer employees, most of whom are college students majoring in various aspects of history, photography, architecture, or engineering. They are also intended for use by other agencies, institutions, contractors, and donors doing documentation to HAER standards for submission to the HAER collection or for their own purposes.

Because the guidelines will be used by inexperienced personnel as well as by professionals, portions of the text are devoted to introductory material. An elementary glossary is included in Section 4.1. However, professionals and experienced recorders will find what they need to produce drawings for inclusion in the HAER collection. With these guidelines, proper guidance from a trained field supervisor, and a review team, HAER employees and other interested (if less experienced) recorders should be able to turn out reliable work.

Review and Consultation. HAER recommends strongly that recording projects retain a secondary review team consisting of maritime specialists appropriate to their project. Vessel owners, crewmembers, shipbuilders, naval architects, marine surveyors, engineers, mechanics, riggers, and maritime historians are some examples of types of consultants who may prove useful. Experts who know the contents and whereabouts of various records collections, histories of vessel types, regions, trades, ship construction and technology, etc., can be of incalculable value in producing excellent documentation, saving time, and avoiding mistakes or serious information gaps. Review teams should go over the vessel being recorded with the documentation team and be permitted periodically to go over a documentation team's work. Ships have significant differences from buildings and there are often several issues and agendas to sort out on a documentation project. Funding, time, expertise, significance of the vessel, extant prior documentation, accessibility of ship structure, present condition and future disposition of the vessel, secondary uses of the documentation, and many other questions can all

affect how a project is planned and what records are produced. The guidelines are not intended to substitute for other references or expert advice, and no written instructions are ultimate substitutes for experience. Professionals may be located through major maritime museums or by contacting the Council of American Maritime Museums, the National Park Service, or the National Trust for Historic Preservation. HAER has a list of some potential consultants, but maintains it only as a courtesy--inclusion on the list should not be construed necessarily as endorsement, nor omission as disapproval.

HAER makes final review of all documentation submitted for conformity to the *Secretary's Standards for Architectural and Engineering Documentation* and to HAER guidelines. The HAER program will gladly review "in progress" phases of a project for direction, content, and quality so that potential problems can be caught before they become serious. Failure to conform to specifications for archival materials and sizes may mean rejection of documentation regardless of its merits. Significant departure from the guidelines is necessary in some instances, but must be properly justified. Inappropriate or poorly produced records will be returned for improvement.

Funding of Documentation Projects. These guidelines do not give guidance for funding projects. Documentation projects operated by HAER are rarely funded by the National Park Service. HAER projects are typically funded on a project-by-project basis from a variety of public and private sources, depending on vessel ownership, location, and the parties interested in (or legally required to perform) documentation to HAER standards. HAER has relied on other Federal, state, and local government agencies and programs, as well as donations, matching grants, and in-kind services from private individuals, interest groups, historical societies, foundations, corporations, and other institutions.

Other HABS/HAER/HALS Guidelines. The *Guidelines for Recording Historic Ships* are part of the following series of guidelines developed by HABS/HAER/HALS for recording various types of historic resources to the *Secretary's Standards*:

- 1) *Historian's Procedures Manual (HABS)*
- 2) *HABS/HAER/HALS Guidelines: Recording Structures and Sites with HABS Measured Drawings*
- 3) *HABS/HAER/HALS Guidelines: Recording Structures and Sites for the Historic American Engineering Record: Historical Reports, Large Format Photography and Measured Drawings*
- 4) *HABS/HAER/HALS Guidelines: Transmitting HABS/HAER/HALS Documentation*

ACKNOWLEDGEMENTS

The *Guidelines for Recording Historic Ships* were first produced in 1988 by the Historic American Buildings Survey/Historic American Engineering Record (HABS/HAER/HALS), National Park Service, United States Department of the Interior. Richard K. Anderson, Jr., HAER Staff Architect, was responsible for the overall outline and contents of the guidelines. Sally K. Tompkins, Deputy Chief of HABS / HAER / HALS, initiated and served as Chief Administrator of the HABS/HAER/HALS Maritime Program. Melanie Dzwonchyk edited the final text for publication in 1988. The second edition was revised and typeset by Richard K. Anderson, Jr. in 1994. New drawing examples and comments in Section 4.7 are based extensively on work by Robbyn L. Jackson, HAER Staff Architect. This third addition was edited and prepared by Todd A. Croteau, HAER Maritime Program Coordinator in 2004.

The development and publication of the first edition of the guidelines was funded by congressional appropriation. The effort was supported by Jerry Rogers, National Park Service Associate Director, Cultural Resources; Rowland Bowers, Deputy Associate Director; and Robert J. Kapsch, Chief, HABS/HAER/HALS Division; and James P. Delgado, Historian, Maritime Initiative, under Edwin C. Bearss, Chief, History Division.

The first printing of the *Guidelines for Recording Historic Ships* was exhausted within 24 months of its appearance in early 1989. In response to demand, HABS/HAER/HALS and the Council of American Maritime Museums (CAMM), Bert Logan, President, jointly funded the revision and printing of the second edition. This third edition includes an update on the use of digital surveying techniques and CAD drawing. This edition was produced in

Mircosoft *Word* for reproduction to CDs and a web downloadable .PDF format.

HAER's program for documenting historic ships grew out of the National Trust for Historic Preservation's Maritime Heritage Task Force which met from 1982 to 1983, and from the draft Guidelines for Documentation produced by the task force's Standards Committee, chaired by Maynard Bray. In 1985, Lynn Hickerson, then Acting Director of the National Trust's Maritime Program, provided the first opportunity for HAER's involvement in recording historic vessels by initiating and funding HAER participation in the lines-lifting of the lumber schooner *Wawona* in Seattle. In 1986, the Trust's new Department of Maritime Preservation under Marcia Myers, Vice President, provided seed money for recording the pilot schooner *Alabama*, HAER's first attempt to fully document a historic vessel. Mystic Seaport Museum, Inc., served as cosponsor of this second project, and its former director, J. Revell Carr, has been supportive of the HAER effort from the beginning. Two other recording projects have been run on historic vessels to develop and test portions of the guidelines, especially Section 4 (Measured Drawings); vessels involved were the bugeye *Louise Travers* (1986), and the ship *Balclutha* (1987-88). The Calvert Marine Museum (Solomons, Maryland) under Dr. Ralph Eshelman, Director, sponsored the field work aboard the *Louise Travers*. Documentation of the *Balclutha* was funded by the Maritime Initiative under James P. Delgado in the National Park Service and was aided by the cooperation of the National Maritime Museum in San Francisco, California (now the San Francisco Maritime National Historic Park). Thanks are due to numerous people associated with these vessels, with project cosponsors, and

with maritime preservationists in general whose expertise and enthusiasm have contributed immeasurably to HAER's growing abilities in the realm of recording historic ships.

As with any such effort, many people and sources were involved in the contents and production of this work. Lynn Hickerson from the Department of Maritime Preservation of the National Trust for Historic Preservation, and Richard Anderson worked closely together during the early developmental stages of the National Trust's Maritime Guidelines and HAER's *Guidelines for Recording Historic Ships* in order to coordinate the scopes of these manuals. Contents of Section 2 (History) were prepared by staff of the Mystic Seaport Museum under Dana Hewson, Shipyard Director. Portions of Section 3 (Photography) were adapted from existing HABS/HAER/HALS "Specifications for the Production of Photographs" by Jack E. Boucher, HABS Staff Photographer.

Portions of Sections 4 (Measured Drawings) were adapted in 1988 from existing HAER *Field Instructions*, whose principal authors were Larry D. Lankton and Richard Anderson. The balance of the 1988 historic ships guidelines were written by Richard Anderson. HAER architect Robbyn L. Jackson aided with the layout of numerous illustrations in Section 4.7. Sally K. Tompkins, Deputy Chief, HABS/HAER/HALS, reviewed and edited drafts of the written text and supervised the project's progress.

Special thanks are due to Maynard Bray and David W. Dillion, who kindly reviewed early drafts of Section 4 and made substantive comments for the 1988 edition. Mr. Dillion also provided a checklist of measurements to be made for sails included in Section 4.3. Welcome contributions by Don Birkholtz, Jr., regarding scantlings for metal vessels and distinguishing between old and new work aboard ships have been included in Sections 1, 4.3 and 4.4. Kevin Foster contributed numerous titles on

steam-powered vessels and the history of steam navigation to Section 2.3, and along with William M. P. Dunne, he contributed to the Introduction to Admeasurement in Section 4.9. HAER also wishes to thank the Museum of American History of the Smithsonian Institution for permission to reproduce drawings from the *Historic American Merchant Marine Survey (HAMMS)* and from the collections of Howard I. Chapelle. These drawings are used extensively in the Measured Drawings section of the 1988 edition of the guidelines.

HAER deeply appreciates the time and thought given by numerous members of the maritime community who were asked to review the final draft and who suggested improvements before these guidelines were published. Many of their comments have been incorporated into the text.

Section 2

HISTORY

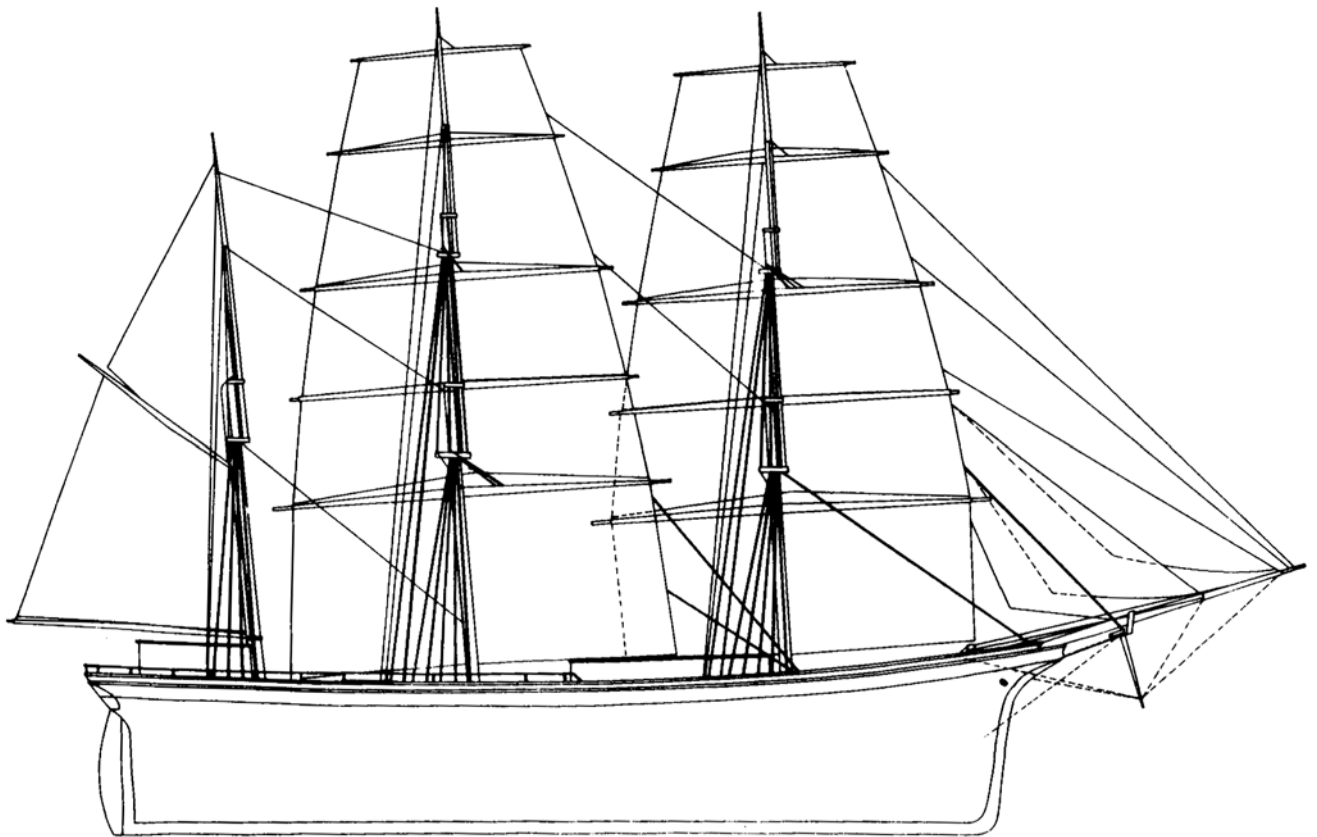

STANDARDS and GUIDELINES

Introduction: The outline format on the following pages provides a quick overview of general applications of the *Secretary's Standards* to the production of HAER historical reports. The text that follows in Sections 2.2-2.4 provides details on how to produce reports that meet the *Secretary's Standards*.

There are four parts to the outline, corresponding to each of the four standards *as they apply to HAER historical reports*:

- I. Guidelines for explicating and illustrating what is significant or valuable about a historic vessel via written reports.
- II. Guidelines for preparing reports accurately from reliable sources.
- III. Guidelines for materials on which reports are to be made.
- IV. Guidelines for producing clear and concise reports.

These standards, as they apply to historical reports, follow well-established scholarly practices and ethical standards.

I. Explicating and illustrating what is significant or valuable about a vessel:

Required

Not Allowed

Determine historically significant data through adequate research into relevant primary and secondary sources, in addition to examination of the physical fabric of the vessel itself.

Determine significant data are best explicated and illustrated by a written report, as opposed to photographs or measured drawings alone.

Determine what contents are best suited to explicating and illustrating the significant and valuable aspects of the resource.

II. Guidelines for preparing historical reports accurately from reliable sources.

Required

Not Allowed

Use **footnotes** and bibliography for complete and accurate citation of primary and secondary sources, whether written, oral, or graphic.

Do not use endnotes.

Report gaps in information accurately.

Report on the reliability of sources used where they may be undefined or in question.

Distinguish supported facts from educated guesses and speculation when drawing conclusions and inferences.

Use sources and the written medium within their capabilities and limitations.

Turn to photography, illustrations, and measured drawings where they can more accurately and succinctly provide evidence, explicate or illustrate a significant point.

Quoting copyrighted information (including graphics) in a HAER report without citation or appropriate written permission from the copyright owner(s).

2.1.4 Historical Report Guidelines

III. Guidelines for materials on which historical reports are to be prepared.

Required

Not Allowed

Prepare final copy of report on 82"x11" archival bond paper (acid-free, 100% cotton, buffered)

IV. Guidelines for producing clear and concise reports.

Required

Not Allowed

Organize a report according to a chronological outline derived from significant aspects of the recorded vessel's history and context.

Producing a report in which type is gray, streaked or smudged

Include proper pagination and headings on each page.

Use a properly completed cover page.

Use Times Roman or Courier typeface at 10 or 12 characters per inch (cpi)

Using fonts smaller than 10pt.

Turn to photography, illustrations, and measured drawings where they can more accurately and succinctly provide evidence, explicate or illustrate a significant point.

Follow established rules of clear professional writing practice in grammar and spelling.

HISTORICAL REPORTS

Introduction. The goals, content, and format of a HAER historical report are addressed below. For the most part, they follow long-recognized approaches, but in addition to customary documentary sources, a thorough understanding of the physical structure of a particular vessel is necessary for a complete understanding of that vessel's history and its place in history. Documenting the history of a ship or boat can be similar to an archeological excavation, because some of the information necessary for a written report will be gathered from physical evidence on the vessel itself. The guidelines that follow presume the user has some experience in historical research and writing, and in interpreting physical evidence. While the guidelines are intended for use by researchers from a variety of backgrounds, they will not cover fundamentals of research and writing techniques.

While you may rely primarily on the written word as a historian, you should work closely with those who are making graphic documentation of the vessel. You will both be uncovering evidence that will help each other in your work. If you are a HAER summer employee, keep in mind that most HAER recording projects operate on a 12-week schedule, and plan your efforts accordingly. Contracted work, or work sponsored by other organizations, is not necessarily subject to these time constraints.

Watercraft present interesting problems to the researcher, not the least of which is their mobility. Evidence of the vessel's history may be scattered worldwide and local information about construction techniques may not have much relationship to the vessel at hand. **Levels of Documentation.** These guidelines give directions primarily for completing historical reports for ships whose significance requires Level I or Level II documentation as set forth in the *Secretary of the Interior's Standards for Architectural and Engineering Documentation*

(see Appendices). Historical reports for Level I or II are substantially the same in content and format; the differences will have more to do with the vessel's significance and available sources than matters of report length or research effort. Guidance given here will also enable the user to complete research for Level III documentation (completion of a one-page "Data Form for Historic Ships" or provide the same information in the standard *Historical Report* format). The data form is self-explanatory, and Fig. 2.2.1 shows a blank copy. A Case Study is included (beginning on p. 2.4.1) as an illustration for Level I/II reports following these guidelines.

Integration of Various Types of

Documentation. The author is responsible for more than merely researching and writing a report. He/she should be conscious that HAER documentation is a package developed from several disciplines. This package contains not only a report, but also formal photographs and may include measured drawings (in Level I documentation). As part of a team, the researcher should help decide what formal photographic views should be scheduled and write captions for them (see pp. 3.2.1 - 3.2.3 for format of "Index to Photographs").

Due to time constraints, the author should be especially sensitive to views that can save pages of lengthy written work; historic views and graphics should be selected for photographic copying when appropriate – *be sure to get copyright releases for images*. When measured drawings are done, the historian should be active in focusing the delineators' efforts on those physical aspects of the ship shown to be significant by the research. The historian should also supply the delineators with notes and that historical information which may be better presented on drawings than in the report. All

NATIONAL PARK SERVICE
HISTORIC LARGE VESSEL INVENTORY

Current name: _____; Official #: _____;	
Previous names: (1) _____	(4) _____
(2) _____	(5) _____
(3) _____	(6) _____
City and State location: _____;	
Builder: _____; Year built: _____;	
Builder location: _____;	
Built for: _____;	
Vessel type: _____;	
Original use: _____;	
Present use: _____;	
Owner: _____;	
Owner's address: _____;	
City/State/Zip: _____;	
# of masts: _____; Rig: _____;	
Length: _____; Beam: _____; Hold Depth: _____; Draft: _____;	
Gross tons: _____; Net tons: _____; Displacement: _____;	
Hull material: _____; Deck material: _____;	
Superstructure material: _____;	
Type of engines: _____; Horsepower: _____;	
Propulsion: _____;	
Armament: _____;	
Condition (circle one):	
POOR	FAIR
GOOD	EXCELLENT
Preservation Objective: _____;	
Date recorded: _____.	

Fig. 2.2.1

written data on drawings should be proofread for content, spelling, etc. In turn, some of the data needed for the report may better be obtained by the delineators. The field report author (and all team members) should take care to decide which medium is best for communicating various types of information. References to photos, measured drawings, and other graphic media should be made where appropriate and efficient rather than relying solely on the written word.

Format. HAER reports are typed double-spaced in 10 or 12 pt. Times Roman or Courier font on only one side of 8-1/2" x 11" sheets of archival bond paper with one-inch margins (minimum) on all sides. The electronic file should be submitted with the paper copy.

Cover Sheet. The first page of all reports is a cover sheet containing the headings and following the format shown on p. 2.3.3.

Pagination. The upper-right-hand corner of every page following the Cover Sheet should contain a three-line single-spaced block with the vessel name, HAER number, and page number as illustrated in the format below.

Schooner ALABAMA
HAER No. MA-64
Page 5

Illustrations. Relevant HAER photos, measured drawings, and photocopies should be referenced directly in your report whenever possible. Selected maps, drawings and other materials not significant enough to be included in the project photographic record may be included in the body of the report as Figures with sources properly cited.

Footnotes. Reports should be fully documented, with footnotes appearing at the bottom of each page. Aside from proper citations, footnotes are useful for explanations or digressions that do not blend well into the flow of your paper.

Bibliography. A full bibliography listing all sources consulted (primary, secondary, graphic, oral, etc.) must appear at the end of your report. You should refer to *The Chicago Manual of Style* (Chicago, 1993) or *A Manual for Writers of Term Papers, Thesis, and Dissertations* by Kate L. Turabian (Chicago, 1996) for proper punctuation and forms.

Word Processors. The use of a word processor is strongly encouraged and electronic files should be submitted to the HAER office along with printouts in order to facilitate the editing process. It is recommended that the HAER office be contacted at the time of the project to determine compatibility of software (**MS WORD7 is the National Park Service standard**).

Assessment. Ships are highly specialized vessels which differ widely among themselves. What makes a vessel significant enough to be documented can vary widely, also: associations with important people or events, embodiment of technological advances, unique construction, or representation of a once-common class of vessel, type of trade or craft, etc.

In some cases, effective documentation is best carried out by focusing intensely on a few historically important elements rather than on complete documentation of the entire ship. It is often of far more value to document the unique and important areas of certain time periods in great detail than to document the entire ship in a more superficial way.

The vessel may have required occasional repair. It is probably unusual to find any watercraft that is old enough to be important historically and has survived without some repair and alteration. Sometimes the newer work is as important as the original; sometimes it is not--a lot depends on factors such as age, extent, quality, technology, etc. It is always valuable to sort out the original fabric from the pieces that came later and to record all changes that occurred up until the vessel was taken out of service.

2.2.4 Historical Reports

Before any documentation begins on a vessel, the vessel should in all cases be inspected by an experienced review team whose members can, with their knowledge of maritime history, traditional construction techniques, and existing documentation, determine whether the documentation project should be complete or partial and what areas should receive the most attention.

The review team should be made up of individuals familiar with the trades the vessel was engaged in and the type of construction being reviewed. They should also be familiar with existing documentation (historic, photographic, drawn, etc.) so that information recorded is not a duplication of information recorded elsewhere.

In establishing priorities, questions such as the following should be considered:

1. What documentation is already available for similar vessels?
2. What portions of the vessel appear to be original and what is repair work, and how much attention, if any, should the latter receive?
3. Where has the original configuration been altered?
4. What is unique about the vessel's construction?
5. If the vessel is to be restored, are there affected areas that should receive special attention early?
6. Are there unique construction details not found in other vessels or ones that have never been documented that are worthy of more than the usual focus?

While much of the above information will be recorded photographically or in the form of measured drawings, it is essential that the field

report author be involved at this time because many of the clues to the vessel's history may be uncovered during this assessment.

After surveying the vessel, the review team will write up the results of its inspection in a prioritized list of areas to be documented, keeping within the documentation team's limitations and offering rationale for its recommendation. This will include specific recommendations as to which portions of the vessel's history need in-depth documentation and which only need refer to other historical research recorded elsewhere. In a case where the ship or boat is to be destroyed after documentation, the review team should make recommendations on which structural elements, if any, should be preserved, based on their importance to the overall construction as well as the practical limitations of warehousing unusually large pieces.

Content. Who? What? Where? When? How? Why? These basic questions apply to ships as well as to any historic subjects, though for ships each question has a slightly different slant. HAER reports are vessel-specific and should concentrate on highlighting what is significant about the particular vessel being recorded without neglecting context.

What follows is an outline that covers the basic information that a history should record. A history need not be limited to these topics but each of the listed topics should be addressed even if the research leads to a dead end. The history may be written in a strictly narrative form using this outline as a check list and developing sections on specific significant aspects as appropriate, or the outline may be more closely followed, filling in available information under each heading and adding new headings or subheadings as applicable.

When pertinent and helpful, tables, diagrams, maps, charts, sketches, fragments of engineering drawings, or illustrations may be included in the body of the report; though these may not be suitable for formal photocopies or inclusion in the measured drawings, they assist the user in understanding the resource. Care must be exercised in the use of copyrighted materials since HAER reports are in the public domain.

A. IDENTIFICATION

1. Name of the Vessel and Official Number

When assigning the primary name to a vessel, the proper name to use is the historic name, which will not change with each new owner or use. The historic name of a vessel often requires careful research to ascertain. It generally should be the name of the vessel when launched. If this information is not available, the present name should be used as the primary name. Always note the origin or source of the historic name in the text of the data pages. And, whenever using the primary name, use all capital letters (e.g., TICONDEROGA).

Occasionally the historic name is not well known, and the persons using the HAER records may not be able to identify a vessel by that designation. Secondary names, which are current or past names, are also included to aid in the use of the HAER records. Any secondary names (in capital letters) are placed in parentheses after the primary name, beginning with the present name and including as many past names as are known.

If the original and present name cannot be determined, a brief description should be used. The vessel is then filed alphabetically by type, as S for schooner.

The official number is assigned by the United States Coast Guard and is on the ship's document. This number is also generally carved into a deck beam or other major structural beam.

Documentation numbers can also be received from the U.S.C.G. Documentation Office. Government vessels generally do not have Official Numbers, but are often designated by alpha numeric codes, such as "YF-356" for yard lighters in the U.S. Navy fleet.

2. HAER Number

Each vessel recorded is given a survey number which consists of an assigned number preceded by the appropriate two-letter state abbreviation, such as *HAER No. PA-146*. HAER will assign these numbers at the request of the person responsible for completing the documentation. Be sure to precede the numbers with "HAER No." to differentiate it from the HABS or HALS collections.

3. Report Prepared By

Use the name of the field report author.

4. Present Location

This includes the number and street, the city or town, county, and state. Because vessels are mobile, or were meant to be, exact locations are helpful, but not nearly as much as in the case of buildings.

Often narrative addresses are needed, such as aground at the foot of Isham Street, at a pier behind 5 Main Street, etc.

If a vessel is located within a commercial establishment such as a shipyard, give the shipyard address and describe where within the yard the boat is located. If the vessel is not located within a village, town, or city, locate it in relationship to the nearest town with a zip code or village name in common usage followed by the word "VICINITY".

2.2.6 Historical Reports

5. Present Owner (including address)

If the vessel is in use, this is a relatively easy bit of information to obtain as the owner's permission will have been required to begin the documentation on the vessel. If the vessel is abandoned or appears to be so, the information can be obtained from the state, by using state registration numbers or from the United States Coast Guard by using the vessel's documentation number, usually carved into a deck beam. The latter approach involves boarding the vessel. Often ownership can most easily be determined by inquiries to local people.

6. Present Use

Give a brief description, and also note here whether a vessel is abandoned, afloat, or accessible.

B. HISTORICAL INFORMATION

1. Historical Significance

Explain why the vessel was selected for documentation. Be brief. The historical context will contain the details.

Examples: last representative of a once-common type, good example of ____ designs, representative of the work done by shipyard.

2. Principal Dimensions

The official or register dimensions of a vessel (such as length, beam, depth, draft, gross and net tonnage) can be very different from actual physical measurements. It is important that you indicate whether you are giving the vessel's admeasured register dimensions, actual physical measurements made by the recording team, or dimensions based on some other definitions or standards. You must clearly distinguish between

each system if you use more than one.

Registered dimensions should be those found in Merchant Vessels of the United States or U.S. Coast Guard records. You would be wise to include the information on the Coast Guard registration form *in full* as an appendix to your report. If registered admeasurements are undetermined, list actual length, breadth, and draft as noted by the delineators. This section is not meant to give exact dimensions but only to give an indication of the size of the boat being dealt with.

3. Physical History

a. Designer. If not determined, state undetermined. A brief biographic entry is appropriate here.

b. Builder/Location. Include the builder's name if an individual and the name of the shipyard where the vessel was built and its location. If not known, state "undetermined."

c. Date of Construction. Include the dates the vessel was under construction and launch date. If unknown, state "undetermined." If estimating the date, indicate by using "circa" and substantiate the estimate. List source(s).

d. Original Price.

e. Original Construction. Give a brief overview. Differentiate between original material and later material. Mention the physical data which will determine what is original as well as contemporary photographs, newspaper clippings, letters, etc. Take particular note of the review team's survey. List all sources used. Include photocopies of historic photographs or clippings when appropriate.

f. Alterations and Additions. Taking note of the review team's survey, which will outline the alterations and additions, include a description of each alteration. Deal with major alterations and changes first. Use your judgment whether to proceed to finer levels of detail (is it a

requirement of project cosponsors, or necessary for the project's end use?). Excruciating and exhaustive documentation of all minor changes is unnecessary for HAER purposes, and perhaps even impossible to do in 12 weeks time. A guideline might be to ask which minor alterations contribute to understanding the major alterations or significant aspects for which the vessel is being recorded.

List all indicators such as photographs, paint lines, wear marks, remnants, fastening holes, etc. Refer to specific HAER drawings or photographs if useful. Also include a chronological list of the changes and, if available, the geographic location of the changes including the persons and shipyard involved with work. List all sources.

4. Historical Context

a. Sources of the Original Name and any others

b. Original and Subsequent Owners. Research chain of ownership and list sources. If not known state "undetermined." National Archives and Record Service, General Services Administration, Washington, DC, can provide locations for storage of Customs House Records.

c. History of Vessel Type (if appropriate)

Be brief in cases where much material already exists, and give references for further background reading. Where history of vessel type is more obscure or untreated, more elaboration should be attempted.

d. Relationship to History

It will not be possible to answer all the questions that could be addressed. *You should be guided by an informed understanding of what is significant about your vessel.* The following remarks are not fool-proof; your work should reflect a thoughtful and creative approach to your vessel.

1. Include information on the vessel's relationship to surroundings and local and maritime events.

2. Relationship to codes, maritime law, Lloyd's, etc. How did these affect ships design, operation, repair, modification?

3. Relationship to economics of a local, national, or international trade or industry--shipbuilding trade, fishing trade, etc. (How much did vessel originally cost? Cost of repairs, modifications, operation? How did this affect ship's design, operation?)

4. Suppliers of materials used in construction and how they relate to the economics of the time and place, repair, modification, obsolescence? Also relationship to general national/international economic conditions, if relevant.

5. How did new technologies, products, or competitors affect the picture? How was ship adapted to these developments?

6. Relationship to ethnic origins of crew, labor, labor unions, practices, laws, housing aboard ship, working conditions, skills, hours, health, pay, etc. How many crew members were there? Did new machines or methods replace men?

7. Relationship to history of technology (may overlap with, but not be same as history of vessel type). Topics might include marine engineering, hull shape, construction and maintenance practices, materials, propulsion systems, navigational instruments, cargo handling, defense/ weaponry, etc. How was the vessel sailed? How were the crew organized and how did they handle the vessel? How did they run the machinery or control the sails? What principles or developments made operation possible?

8. Relationship to local communities, politics, international treaties, wars, corporate politics (local/national/ international), etc.

9. Intangibles--the human element of cultural values and personal quirks--things like pride of

2.2.8 Historical Reports

workmanship, sense of tradition, sense of esthetics, greed, ambition, etc.

10. Relationship to literature, folklore, arts, crafts, music, etc.

Sources of Information. Below is a list of sources which can aid in the documentation process of ships and boats. Such things as the original design, construction, arrangement, rig, equipment, and color scheme as well as information on the general history and the historical significance of the vessel can be determined through the study of good source material. Knowledge of the vessel and its history is essential in order to evaluate the sources and judge their credibility.

Oftentimes contradictory information can be gathered from several different sources. As a general rule, the validity of sources which are based on an individual's interpretation or point of view (paintings, models), should be determined by assessing their credibility. Rely on the most substantial source material but note conflicting sources.

When recording sources, refer to all pertinent sources and evaluate them as to reliability, bias, and errors. Include complete information on every source located and annotate the sources with useful information such as "includes reproduction of original drawings."

Sources will be dependent upon priorities, time available, etc. Note that some sources will be investigated at a later date and will be added to the date pages, so leave clear "foot prints" which can be followed. This is important even if a search turns up nothing so that any subsequent research will not have to go down the same dead end road.

Repositories or owners of the following should be noted, if any:

Plans (Lines, Construction, Deck and Interior Layout, Sail Rigging, etc.) List all plans and give the date and location of the material. Include a brief description and evaluation.

Old Photographs. List the date of the photograph, identifying numbers, and the location of the original photograph. Include the photographer's name if available.

Models and Half Models. List the date, builder, and location of model. Include a brief description and evaluation.

Paintings, Engravings, etc. List the artist's name, date, identifying numbers, and the location of the artwork. Include a brief description and evaluation.

Books, Periodicals, Newspapers, and any Other Published Material. List title, author, date, location, identifying numbers, and publisher. Include a brief description and evaluation.

Logbooks, Account Books, Invoices, and Other Unpublished Material. List title, author (if available), date, location, and identifying numbers. Include a brief description and evaluation.

Oral History (Taped Interviews). List date, name of interviewee with brief background, name of person conducting the interview with brief background, identifying numbers, and location. Include a brief description of the contents of the interview and evaluate the source as to its reliability, biases, knowledge of the subject, etc.

Maritime Equipment and Artifacts. Include maritime artifacts which are pertinent to vessel use. Note equipment such as buckets, lanterns, compasses, windlasses, engines, working gear,

etc. Be brief when catalogs can be used for complete description of use and dimensions. List date, artifact with a brief description of its usage, identifying numbers, name of manufacturer, location, and source of data.

Videos and Movies. List subject, date, location, relevance, and a brief description of contents. Include an evaluation of the source.

Surveys. List date, name of person(s) conducting the survey, and a brief description of the contents. Include an evaluation of the source.

Local Sources. Include boat builders, users, historians, merchants, collectors, historical societies, libraries, museums, newspapers, census documents, etc. Collections may be found in basements, cafes, shipyards, marinas, etc. Note that local sources include those local to the vessel's location when built, when rebuilt, and when in use.

State, Regional, National, and International Sources. Include libraries, museums, historical societies, custom houses, expositions, professional researchers, etc. List date, location, description, and identifying numbers. Include the source and evaluate the source.

Location of Sources. Think creatively when deciding where to look for sources. The General Bibliography given on pp. 2.2.1 - 2.1.16 is very broad. Developing a network of contacts can be critical to finding valuable tips specific to your vessel.

Then there is always the "serendipity factor": the book or periodical most appropriate to your vessel may have been published in Seaville, Kansas, only eight copies were made, and they are now available only in Ed Hodge's basement, 9 Blake Avenue, Seaville. It was written by his grandfather, who happens to be the father-in-law of the local librarian you contacted.

Customs House records, local "Merchant Vessels" newspapers, builders' lists, and

merchants catalogs are good sources for the bare facts.

Contact naval architects, historians, and collectors for more information, plans, memorabilia, photographs, and journals. These people will be local, regional, national, and often international.

The library, museum gallery, and historical society, local as well as those nationally known, are essential. They contain newspapers, books, plans, paintings, manuscripts, letters, tapes, periodicals, photographs, indexes, artifacts, and experts.

Search for the old boat yard; the repository of historic material which disappeared when the boatyard gave way to Tim's Cafe. Track down the old rigger who left his home in Seattle for Sun City and find the Key West captain's grandson who has the photo albums in Chicago.

Consult both well-known and obscure photographers and artists who covered the waterfront.

A foreign maritime museum or library may be the only source for models and textural material on the vessel. The only Seaville skiff model may be in Bergen, Norway, for example.

Talk with people who used the vessel. Have them sketch the location of the bait box, for example; find out in detail how the boat and the equipment were used. Recording the conversations may be the most efficient method. Know in advance if other oral histories are available and how to obtain them.

Try to trace changes which were made during the useful life of the vessel and its various uses by studying the tradition, new inventions, characteristic of locale, and economics.

Constantly evaluate the credibility of each location and list all locations searched. Indicate ones you did not follow up on, and the reasons.

GENERAL BIBLIOGRAPHY

The bibliography below is intended as a starting point for research. More extensive bibliographies (such as Albion's) are listed below. Merchant vessels are concentrated upon, though some naval references are also included. Many references are old, but they are included because they may prove useful in describing technologies and developments contemporary to now-historic vessels. See Section 4.8 for further technical works. Many authors may have written other works--check card catalogs under names you are interested in to see what else may be available.

I. Field Library

1. Guidelines

Ives, Edward D. *The Tape-Recorded Interview: A Manual for the Field Workers in Folklore and Oral History*. Knoxville, Tenn.: University of Tennessee Press, 1980.

Lipke, Paul, Peter Spectre, and Benjamin A.G. Fuller, eds. *Boats: A Manual for Their Documentation*. Nashville, Tenn.: American Association for State and Local History for the Museum Small Craft Association, 1993.

Strunk, William Jr., and E.B. White. *The Elements of Style*. 3rd ed. New York, N.Y.: The MacMillan Company, 1979.

Taylor, David A. *Documenting Maritime Folklife:*

United States Department of the Interior, National Park Service. *Guidelines for Recording Historic Ships*. Washington, D.C.: U.S. Department of the Interior, National Park Service, Historic American Historic American Engineering Record, 1988.

_____. *National Register Bulletin*. Washington, D.C.: U.S. Department of the Interior, National Park Service, Interagency Resources Division, 1985.

2. Dictionaries

Baker, William A. *The Lore of Sail*. New York, N.Y.: Facts on File Publications, 1983.

de Kerchove, Rene. *International Maritime Dictionary*. 2nd ed. 1961.

Department of Foreign and Domestic Trade, United States Merchant Marine Cadet Corps, War Shipping Administration. *A Glossary of Legal, Insurance and Shipping Terms*. Kings Point, N.Y.: United States Merchant Marine Cadet Corps, 1945. (mimeograph)

Eddington, Walter J. *Glossary of Shipbuilding and Outfitting Terms*. New York, N.Y.: Cornell Maritime Press, 1943.

Kemp, Peter, ed. *The Oxford Companion to Ships and the Sea*. London, Melbourne, New York: Oxford University Press.

Middendorf, Friedrich Ludwig. *Bemastung und Takelung der Schiffe*. Berlin: Verlag von Julius Springer, 1903. Reprinted in 1977 by Horst Hamecher Kassel; untranslated.

Paasch, H. *From Keel to Truck: A Marine Dictionary, English French and German*. Antwerp, Holland: Ratinckx Freres, 1885.

Paasch, Capt. H. *Illustrated Marine Encyclopedia, An Introductory Guide to the English, Dutch, and 1890 War Guide, W. England, D.G.S. Books, Ltd., 1977.* Library of Congress

Pease, F. Forrest. *Modern Shipbuilding Terms: Defined and Illustrated*. Philadelphia, Pa.: J.B. Lippincott Company, 1918.

Rogers, John G. *Origins of Sea Terms*. Mystic, Ct.: Mystic Seaport Museum, Inc., 1984.

Tryckare, Tre. *The Lore of Ships*. New York, N.Y.: Crescent Books, 1963. *The Visual Encyclopedia of Sea Terms Undersail*. 1st ed. 1978.

Webster, F.B., et al., eds. *Shipbuilding Cyclopedia*.

2.3.2 General Bibliography

New York, N.Y.: Simmons-Boardman Publishing Co., 1920.

3. *Bibliographies and References*

Albion, Robert G. *Naval and Maritime History: An Annotated Bibliography*. 4th ed. Mystic, Ct.: The Marine Historical Association, Inc., 1972.

Brouwer, Norman J. "Maritime Preservation Bibliography." Washington, D.C.: National Trust for Historic Preservation, 1983. (unpublished manuscript)

Feltner, Dr. Charles E., and Jeri Baron Feltner. *Great Lakes Maritime History: Bibliography and Sources of Information*. Dearborn, Mich.: Seajay Publications, 1982.

Historical Periodicals Directory. Santa Barbara, Ca.; Oxford, Eng.: ABC-Clio, Inc.

Kinnell, Susan K., and Suzanne R. Ontiveros, ed. *American Maritime History: A Bibliography*. Santa Barbara, Ca.; Oxford, Eng.: ABC-Clio, Inc.

Labaree, Benjamin W. *A Supplement (1971-1986) to Robert G. Albion's Naval and Maritime History: An Annotated Bibliography*. 4th ed. Mystic, Ct.: Mystic Seaport Museum, Inc., 1988.

Mooney, James L., ed. *Dictionary of American Naval Fighting Ships*. Washington, D.C.: Department of the Navy, Naval Historical Center, 1981. 8 vols.

Untapped Resources and Research Opportunities in the Field of American Maritime History. Mystic, Ct.: The Marine Historical Association, Inc., Mystic Seaport, 1967.

II. Research Guidelines

Barzun, Jaques, and Henry F. Graff. *The Modern*

Researcher. New York, N.Y.: Harcourt, Brace and World, 1970.

Cantor, Norman F., and Richard I. Schneider. *How to Study History*. New York, N.Y.: Thomas Y. Crowell, 1967.

Felt, Thomas. *Researching, Writing, and Publishing Local History*. Nashville, Tenn.: American Association for State and Local History, 1976.

Gottschalk, Louis. *Understanding History*. New York, N.Y.: Alfred Knopf, reprinted 1960.

Gray, Wood, et al. *Historian's Handbook*. 1964.

Shafer, R.A., ed. *A Guide to Historical Method*. Homewood, Ill.: The Dorsey Press, 1969.

Stevenson, Noel C. *Search and Research*. Salt Lake City, Utah: Desert Book Co., 1979.

Tilden, Freeman. *Interpreting Our Heritage: Principles for Visitor Services in Parks, Museums, and Historic Places*. Chapel Hill, N.C.: University of North Carolina Press, 1957.

III. Vessel Types

A. *Wooden Boats over 40 Feet*

1. *Construction and Materials*

Abell, Sir Westcott Stile. *The Shipwright's Trade*. Cambridge, Eng.: University Press, 1948.

American Bureau of Shipping. *Rules for the Construction and Classification of Wooden Ships*. New York, N.Y.: American Bureau of Shipping.

Curtis, W.H. *The Elements of Wooden Ship Construction*. New York, N.Y.: McGraw-Hill Book Company, 1919.

Desmond, Charles. *Wooden Shipbuilding*. Vestal, N.Y.: The Vestal Press Ltd., 1984.

Dodds, James, and James Moore. *Building the Wooden Fighting Ship*. New York: Facts on File Publications, 1985.

Estep, H. Cole. *How Wooden Ships Are Built*. New York, N.Y.: W.W. Norton Co., 1918.

Eyres, D.J. *Ship Construction*. 2nd ed. London, Eng.: Weinemann, 1978.

Frost, Ted. *From Tree to Sea*. Lavenham, Suffolk, Eng.: Terence Dalton Limited, 1985.

Garyantes, Hugo F. *Handbook for Shipwrights*. New York, N.Y.; London, Eng.; McGraw-Hill Book Co., Inc., 1944.

Hegarty, Reginald B. *Birth of a Whaleship*. New Bedford, Ma.: New Bedford Free Public Library, 1964.

MacGregor, David R. *Fast Sailing Ships: Their Design and Construction 1775-1875*. Lymington, Hampshire, England: Nautical Publishing Company, Ltd., 1973.

Mackrow, Clement. *The Naval Architect's and Shipbuilder's Pocket Book*. London, Eng.: Crosby, Lockwood and Son, 1902.

Putz, George, and Marc Halevi. *The Spirit of Massachusetts: Building a Tall Ship*. Thorndike, Me.: Thorndike Press, 1984.

Simmons, Walter J. *Finishing*. Lincolnville, Me.: Duck Trap Woodworking, 1984.

Story, Dana A. *Frame-Up*. Barre, Ma.: Barre Publishing Co., 1964.

—. *The Building of A Wooden Ship: "Sawn Frames and Trunnel Fastened"*. Barre, Ma.: Barre Publications, 1971.

United States Shipping Board, Emergency Fleet Corp. *The Elements of Wooden Ship Construction*. Part 1. Philadelphia, Pa.: United States Shipping Board, Emergency Fleet Corp., 1918.

Wood, Virginia Steele. *Live Oaking: Southern Timber for Tall Ships*. Boston, Ma.: Northeastern University Press, 1981.

2. Rigging

Biddlecombe, Capt. George. *The Art of Rigging: Containing an Explanation of Terms and Phrases, and the Progressive Method of Rigging Expressly Adapted for Sailing Ships*. Salem, Ma.: Marine Research Society, 1925.

Bolger, Philip C. *100 Small Boat Rigs*. Camden, Me.: International Marine Publishing Co., 1984.

Jensen, Jens Kusk. *Haandbog I Praktisk Somandsskab; Handbook of Practical Seamanship*. Copenhagen, Denmark: Host and Sons Forlag, 1982.

Leather, John. *Spritsails and Lugsails*. London, Eng.; New York, N.Y.: Adlard Coles Ltd., 1979.

Luce, S.B., Rear Admiral U.S. Navy. *Textbook of Seamanship*. New York, N.Y.: Van Nostrand, 1898.

Morris, Edward P. *The Fore and Aft Rig in America*. New Haven, Ct.: Yale University Press; London, Eng.: Oxford University Press, 1927.

Riessenberg, Felix C.E. *Standard Seamanship for the Merchant Service*. New York, N.Y.: Van Nostrand, 1922.

Totten, B.J., Commander U.S. Navy. *Naval Textbook and Dictionary*. New York, N.Y.: Van Nostrand, 1862.

Underhill, Harold J. *Masting and Rigging the Clipper Ship and Ocean Carrier*. Glasgow, Scotland: Brown, Son and Ferguson, Ltd., 1958.

3. History

Baker, William A. *Sloops and Shallops*. Barre, Ma.: Barre Publishing Co., 1966.

The Canal Museum. *A Canal Boat Primer on the Canals of New York State*. Syracuse, N.Y.: The Canal Museum, 1981.

Chapelle, Howard I. *The American Fishing Schooners 1825-1935*. New York, N.Y.: W.W. Norton Co., 1973.

2.3.4 General Bibliography

- . *The History of American Sailing Ships*. New York, N.Y.: W.W. Norton Co., 1935.
- . *The National Watercraft Collection*. Washington, D.C.: Smithsonian Institution, 1960.
- Church, Albert Cook. *American Fishermen*. New York, N.Y.: W.W. Norton Co., 1940.
- Garland, Joseph E. *Down to the Sea: The Fishing Schooners of Gloucester*. Boston, Ma.: David R. Godine, 1983.
- German, Andrew V. *Down on T Wharf*. Mystic, Ct.: Mystic Seaport Museum, Inc., 1982.
- Goode, George B. *The Fisheries and Fishing Industry of the United States*. Washington, D.C.: Government Printing Office, 1887.
- Greenhill, Basil. *Archeology of the Boat: New Introductory Study*. Middletown, Ct.: Wesleyan University Press, 1976.
- Haley, Nelson Cole. *Whale Hunt: The Narrative of a Voyage by Nelson Cole Haley, Harpooner in the Ship CHARLES W. MORGAN, 1849-1853*. New York, N.Y.: I. Washburn, 1948.
- Hall, Elton W. *Sperm Whaling from New Bedford: Clifford W. Ashley's Photographs of Bark SUNBEAM, in 1904*. New Bedford, Ma.: Old Dartmouth Historical Society.
- Hardy, A.C. *American Ship Types: A Review of the Work, Characteristics, and Construction of Ship Types Peculiar to the Waters of the North American Continent*. (New York, N.Y.: D. Van Nostrand Company, 1927).
- Harland, John. *Seamanship in the Age of Sail*. Annapolis, Md.: The Naval Institute Press, 1984.
- Hornell, James. *Water Transport*. Cambridge, Eng.: Cambridge University Press, 1946.
- Institution of Naval Architects. *Transactions of the Institution of Naval Architects*. London, England.
- International Marine Archives, Nantucket, Ma.* Nantucket, Ma.: International Marine Archives, 1976.
- Johnstone, Paul. *The Sea-Craft of Prehistory*. Cambridge, Ma.: Harvard University Press, 1980.
- Kochiss, John M. *Oystering from New York to Boston*. Middletown, Ct.; Wesleyan University Press, 1974.
- Laughton, L.G. Carr. *Old Ship Figure-heads and Sterns*. New York: N.Y.: Burt Franklin, 1973.
- McFarland, Raymond. *A History of the New England Fisheries*. Philadelphia, Pa.: University of Pennsylvania; New York, N.Y.: D. Appleton and Co., 1911.
- . *The Masts of Gloucester: Recollections of a Fisherman*. New York, N.Y.: W.W. Norton Co., Inc., 1937.
- M'Kay, Lauchlan. *The Practical Shipbuilder*. New York, N.Y.: Collins, Keese and Company, 1839.
- Morris, James. *Our Maritime Heritage: Maritime Developments and Their Impact on American Life*. Washington, D.C.: University Press of America, 1979.
- Pierce, Wesley George. *Goin' Fishin': The Story of Deep Sea Fishermen of New England*. Salem, Ma.: Marine Research Society, 1934.
- Society of Naval Architects and Marine Engineers. *Historical Transactions*. New York, N.Y.: The Society of Naval Architects and Marine Engineers.
- Worcester, G.R.G. *The Junks and Sampans of the Yangtze*. Annapolis, Md.: Naval Institute Press, 1971.
- B. Wooden Vessels Under 40 Feet**
- Ansel, Willits D. *The Whaleboat: A Study of Design, Construction and Use, 1850-1870*. Mystic, Ct.: Mystic Seaport Museum, Inc., 1978.
- Atkin, William, and John Atkin. *The Book of Boats*. Camden, Me.: International Marine Publishing Co., 1976.

- Blanchard, Fessenden S. *The Sailboat Classes of North America*. New York, N.Y.: Doubleday and Co., 1973.
- Bolger, Phillip C. *Small Boats*. Camden, Me.: International Marine Publishing Co., 1973.
- Brewington, M.V. *Chesapeake Bay Log Canoes and Bugeyes*. Cambridge, Md.: Cornell Maritime Press, Inc., 1963.
- Burke, John. *Pete Culler's Boats: The Complete Design Catalog*. Camden, Me.: International Marine Publishing Co., 1984.
- Cannell, David, and John Leather. *Modern Developments in Yacht Design*. New York, N.Y.: Dodd, Meade, 1976.
- Carrick, Robert, and Richard Henderson. *John G. Alden and His Yacht Design*. Camden, Me.: International Marine Publishing Co., 1983.
- Catalog of Boat Building Plans and Books*. New York, N.Y.: The MacMillan Co., Inc., 1942.
- Chapelle, Howard I. *American Sailing Craft*. New York, N.Y.: Kennedy Brothers, Inc., 1936.
- . *Boatbuilding: A Complete Handbook of Wooden Boat Construction*. New York, N.Y.: W.W. Norton and Co., 1936.
- Connecticut, State of. *Shell Fish Commission Report, 1901*.
- Culler, R.D. *Skiffs and Schooners*. Camden, Me.: International Marine Publishing Co., 1974.
- Darwin, Tom. *The Rudder Treasury*. New York, N.Y.: The Rudder Publishing Co., 1953.
- Durant, Kenneth, and Helen Durant. *The Adirondack Guide-Boat*. Camden, Me.: International Marine Publishing Co., 1980.
- Gardner, John. *Basic Boatbuilding*. Mystic, Ct.: Mystic Seaport Museum, Inc., 1972.
- . *Building Classic Small Craft*. Camden, Me.: International Marine Publishing Co., 1977.
- . *Classic Small Boats*. New York, N.Y.: American Sportsman, 1969.
- . *The Dory Book*. Camden, Me.: International Marine Publishing Co., 1978.
- Guthorn, Peter J. *The Sea Bright Skiff and Other Jersey Shore Boats*. New Brunswick, N.J.: Rutgers University Press, 1971.
- Herreshoff, Lewis Francis. *The Complete Cruiser*. New York, N.Y.: Sheridan House, 1963.
- . *Sensible Cruising Designs*. Camden, Me.: International Marine Publishing Co., 1973.
- Ingersol, Ernest. "The Oyster Industry." *Tenth Census of the United States*. Washington, D.C.: Government Printing Office, 1884.
- Jones, Herald A., ed. *It's a Friendship*. Rockland, Me.: The Friendship Sloop Society, 1962.
- Leather, John. *Clinker Boatbuilding*. Camden, Me.: International Marine Publishing Co., 1973.
- . *The Big Class Racing Yachts*. 1st British ed. London, Eng.: Stanford Maritime, 1982.
- Leavens, John M., ed. *The Catboat Book*. Camden, Me.: International Marine Publishing Co., 1973.
- Lipke, Paul. *Plank On Frame*. Camden, Me.: International Marine Publications, 1981.
- Manley, Atwood. *Rushton and His Times in American Canoeing*. Syracuse University Press, 1968.
- McKee, Eric. *Clenched Lap or Clinker*. Greenwich, London, Eng.: National Maritime Museum, 1973.
- . *Working Boats of Britain; Their Shape and Purpose*. 1st British Edition. London, Eng.: Conway Maritime Press in association with the National Maritime Museum, 1983.
- North American Yacht Racing Union. *Scantling Rules for Yachts Built to the Universal Rule in Classes of 46 Foot Rating and Below*. New York, N.Y.: American Yacht Racing Union, 1929.
- Patterson, Harold W. *Small Boat Building*. New

2.3.6 General Bibliography

York, N.Y.: The MacMillian Co., 1972.

Rabl, Samuel S. *Boat Building in Your Own Back Yard*. Cambridge, Md.: Cornell Maritime Press, 1958.

Roberts, Al, ed. *Enduring Friendships*. Camden, Me.: International Marine Publishing Co., 1970.

Schoettle, Edwin J., ed. *Sailing Craft*. New York, N.Y.: The MacMillian Co., Inc., 1927.

Simmons, Walter. *Lapstrake Boatbuilding*. 2 vols., revised and updated. Lincolnton Beach, Me.: Duck Trap Woodworking, 1983.

Smith, Harvey G. *Boat Carpentry*. 1st ed. Princeton, N.J.: Van Nostrand, 1955.

Stephens, W.P. *Canoe and Boatbuilding*. New York, N.Y.: Forest and Stream Publishing Co., 1889.

Steward, Robert M. *Boatbuilding Manual*. Camden, Me.: International Marine Publishing Co., 1970.

Thomas, Barry Gifford. *Building of the Herreshoff Dinghy; Manufacturer's Method*. Mystic, Ct.: Mystic Seaport Museum, Inc., 1977.

Webb, Frank Rush. *Manual of the Canvas Canoe; Its Construction*. New York, N.Y.: Forest and Stream, 1898.

C. Iron Hulled Vessels

Grantham, John. *Iron Ship-Building*. 5th ed. London, Eng.: Virtue and Co., 1886.

Reed, E.J. *Shipbuilding in Iron and Steel*. London, Eng.: John Murray, 1869.

Thearle, Samuel James Pope. *The Modern Practice of Shipbuilding in Iron and Steel*. 2nd ed. London, Eng.: William Collins, 1891.

Wilson, Theodore D. *An Outline of Ship Building Theoretical and Practical*. New York, N.Y.: John Wiley and Son, 1873.

D. Steel Hulled Vessels

American Bureau of Shipping. *Rules for the Classification and Construction of Steel Ships*. New York, N.Y.

Arnott, David, ed. *Design and Construction of Steel Merchant Ships*. New York, N.Y.: Society of Naval Architects and Marine Engineers, 1955.

Baker, Elijah III. *Introduction to Steel Shipbuilding*. New York, N.Y.: McGraw Hill, 1953.

Holmes, A. Campbell. *Practical Shipbuilding: A Treatise on the Structural Design and Building of Modern Steel Vessels*. London, Eng.: Lonmans, Green and Company, 1918. 2 vols.

Talbot-Booth, E.C. *Merchant Ships*. England: MacMillan, 1943.

Walton, Thomas. *Steel Ships: Their Construction and Maintenance*. London, Eng.: Griffin and Co. Ltd., 1902.

E. Steam Powered Vessels

1. History

Ambler, Charles Henry. *A History of Transportation in the Ohio Valley*. Westport, Ct.: Greenwood Press Publishers, 1970.

Fletcher, R.A. *Steam-ships: The Story of Their Development to the Present Day*. Philadelphia, Pa.: J.B. Lippincott Company, 1910.

Institution of Naval Architects. *Transactions of the Institution of Naval Architects*. London, England.

Jacobus, Melancthon W. *The Connecticut River Steamboat Story*. Hartford, Ct.: The Connecticut Historical Society, 1956.

Morrison, John H. *History of American Steam Navigation*. New York, N.Y.: Stephen Daye Press, 1958.

Petersen, William J. *Steamboating on the Upper Mississippi*. Iowa City: The State Historical Society of Iowa, 1968.

Preble, George Henry. *A Chronological History of the Origin and Development of Steam Navigation 1543-1882*. Philadelphia, Pa.: L.R. Hamersly and Company, 1883.

Ridgely-Nevin, Cedric. *American Steamships on the Atlantic*. Newark, Del.: University of Delaware Press, 1981.

Rowland, K.T. *Steam at Sea: A History of Steam Navigation*. New York, N.Y.: Praeger Publishers, 1970.

Smith, Edgar C. *A Short History of Naval and Marine Engineering*. Cambridge, Eng.: The University Press, 1937.

Society of Naval Architects and Marine Engineers. *Historical Transactions*. New York, N.Y.: The Society of Naval Architects and Marine Engineers. (Numerous years)

Spratt, H. Philip. *The Birth of the Steamboat*. London, Eng.: Charles Griffin and Company, Ltd., 1958.

Tyler, David Budlong. *Steam Conquers the Atlantic*. New York, N.Y.: D. Appleton-Century Company, 1939.

2. Vessel Types

Bates, Alan L. *The Western Rivers Steamboat Cyclopedium or American Riverboat: Structure and Detail*. Leonia, N.J.: Hustle Press, 1968.

Baxter, Raymond J., and Arthur G. Adams. *Railroad Ferries of the Hudson and Stories of a Deckhand*. Woodcliff Lake, N.J.: Lind Publications, 1987.

Hilton, George W. *The Great Lakes Car Ferries*. Berkeley, Calif.: Howell-North Books, 1962.

Mitchell, Richard M. *The Steam Launch*. Camden, Me.: International Marine Publishing Company, 1982.

Newell, Gordon, and Joe Williamson. *Pacific Coastal Liners*. Seattle, Wash.: Superior Publishing

Company, 1959.

3. Technical (Naval Architecture and Marine Engineering)

Babcock & Wilcox Company. *Marine Steam*. New York, N.Y.: The Babcock & Wilcox Company, 1918.

Babcock & Wilcox Company. *Steam*. New York, N.Y.: The Babcock & Wilcox Company (numerous years).

Barton, John K. *Naval Reciprocating Engines and Auxiliary Machinery: A Textbook for the Instruction of Midshipmen at the U.S. Naval Academy*. Annapolis, Md.: The United States Naval Institute, 1914.

Bourne, John. *A Treatise on the Steam Engine and Its Application to Mines, Mills, Steam Navigation and Railways*. London, Eng.: Longman, Brown, Green, and Longmans, 1851.

Bridger, Capt. H.H., and Oswald M. Watts. *The Stowage of Cargo: A Practical Treatise on the Description, Handling, and Stowage of Cargo*. London, England: Imray, Laurie, Norie and Wilson, Ltd., 1927.

Carmichael, A.W. *Practical Ship Production*. New York, N.Y.: McGraw-Hill Book Company, Inc., 1919.

Edwards, Emory. *Modern American Marine Engines, Boilers, and Screw Propellers: Their Design and Construction*. Philadelphia, Pa.: Henry Carey Baird and Company, 1886.

Hillcoat, Charles H. *Notes on the Stowage of Ships: A Handy Book upon the Stowage of Cargoes, with Weights and Measures*. New York, N.Y.: Colonial Publishing Company, 1919.

Holmes, A. Campbell. *Practical Shipbuilding: A Treatise on the Structural Design and Building of Modern Steel Vessels*. London, Eng.: Lonmans, Green and Company, 1918. 2 vols.

International Correspondence Schools Reference Library. Vol. 170 "Marine Engines, Marine

2.3.8 General Bibliography

- Pumps." Scranton, Pa: International Textbook Company, 1907.
- International Library of Technology*. Vol. 9B "Marine Boilers, Refrigeration." Scranton, Pa: International Textbook Company, 1907.
- Lyon, Frank, Lieut. Commander U.S. Navy, and Lieut. Commander A.W. Hinds, U.S. Navy. *Marine and Naval Boilers*. Annapolis, Md.: The United States Naval Institute, 1915.
- Seaton, A.E. *A Manual of Marine Engineering Comprising the Design, Construction, and Working of Marine Machinery*. London, Eng.: Charles Griffin and Company, Ltd., 1928.
- Seward, Herbert Lee. *Marine Engineering*. Vol. I. New York: The Society of Naval Architects and Marine Engineers, 1942. Eleventh printing 1968.
- . *Marine Engineering*. Vol. II. New York: The Society of Naval Architects and Marine Engineers, 1944. Eleventh printing 1968.
- Sothorn, J.W.M. "Verbal" *Notes and Sketches for Marine Engineers: A Manual of Marine Engineering Practice*. Glasgow, Scotland: James Monroe and Company, Ltd., 1915.
- Sterling, Frank Ward, ed. *Marine Engineers' Handbook*. New York: McGraw-Hill Book Company, Inc., 1920.
- F. Yachts**
- Chapelle, Howard I. *Yacht Designing and Planning for Yachtsmen, Students and Amateurs*. New York, N.Y.: W.W. Norton Co., 1936.
- Fox, Uffa. *Sailing, Seamanship, and Small Yacht Construction*. New York, N.Y.: Charles Scribner's Sons, 1934.
- Herreshoff, L. Francis. *The Common Sense of Yacht Design*. Jamaica, N.Y.: Caravan-Maritime Publishing Co., 1966.
- Kemp, Dixon. *Yacht Architecture: A Treatise on the Laws Which Govern Resistance of Bodies Moving in Water*. London, Eng: H. Cox, 1885.
- Kinney, Francis S. *Skene's Elements of Yacht Design*. 8th edition. New York, N.Y.: Dodd, Meade and Co., 1981.
- Kunhardt, C.P. *Small Yachts*. New York, N.Y.: Forest and Stream Publishing Co., 1887.
- Rousmaniere, John. *The Golden Pastime; A New History of Yachting*. New York, N.Y.: W.W. Norton, c. 1986.
- Stephens, William D. *Traditions and Memories of American Yachting*. Reprinted from Motor Boating. New York, N.Y.: Hearst Magazines, Inc., 1941.
- Vaughan, T.J. *International Fourteen Foot Dinghy 1928-1964; Handbook and History*. London, Eng.: International Fourteen Foot Dinghy Class Association of Great Britain, 1964.
- G. Ship Models**
- Ronnberg, Erik A. *To Build a Whaleboat: Historical Notes and a Model Maker's Guide*. New Bedford, Ma.: Old Dartmouth Historical Society, 1985.
- Waite, A. H. *Catalogue of Ship Models, Part 1: Ships of the Western Tradition to 1815*. Greenwich, Eng.: National Maritime Museum, 1981.
- IV. Vessel Registration**
- Annual List of Merchant Vessels of the United States*. Washington, D.C.: Government Printing Office.
- Brouwer, Norman J. *International Register of Historic Ships*. Annapolis, Md.: Naval Institute Press, 1985.
- Jackson, Melvin H., ed. *Historic American Merchant Marine Survey*. Salem, N.H.: Ayer Co., 1983.
- Lloyd's Register of British and Foreign Shipping*. London, Eng: Lloyd's Register of British and Foreign Shipping.
- V. Directories**

A. Maritime Museum Directory

- American Association of Museums. *The Official Museum Directory*. Skokie, Ill.: National Register Publishing Company, 1980.
- Howe, Edward Hartley. *North America's Maritime Museums: An Annotated Guide*. New York, N.Y.: Facts on File, 1987.
- Landauer, Lyndall B., and Donald A. Landauer. *Pacific Marine Museums: And Data Research Centers*. Pasadena, Ca.: Flying Cloud Publishers, 1985.
- Nautical Museum Directory*. 4th ed. New York, N.Y.: Quadrant Press, Inc., 1976.

VI. Published Documentation on Individual Historic Vessels

- Braynard, Frank O. *S.S. Savannah: The Elegant Steam Ship*. New York, N.Y.: Dover Publications, Inc., 1963.
- DeLong, Harriet Tracy. *Pacific Schooner WAWONA*. Bellevue, Wash.: Documentary Book Publishers Corporation, 1985.
- Jackson, Melvin H., ed. *The Historic American Merchant Marine Survey, Works Progress Administration, Federal Project No. 6*. Salem, N.H.: The Ayer Company, 1983. 7 vols.
- Kline, M.S. *Steamboat Virginia V*. Bellevue, Wash.: Documentary Book Publishers Corporation, 1985.
- Lambert, Andrew. *Warrior: The World's First Ironclad, Then and Now*. Annapolis, Md.: Naval Institute Press, 1987.
- Owsley, Frank Lawrence, Jr. *The C.S.S. FLORIDA: Her Building and Operations*. The University of Alabama Press, 1987.
- Summersell, Charles Grayson. *C.S.S. ALABAMA: Builder, Captain and Plans*. The University of Alabama Press, 1985.

VII. Photography

- Borchers, Perry E. *Photogrammetric Recording of Cultural Resources*. Washington, D.C.: Technical Preservation Services, 1977.
- Chambers, J. Henry. *Rectified Photography and Photo Drawings For Historic Preservation*. Washington, D.C.: Technical Preservation Services, 1975.
- Time-Life Books. "The Camera" (1970); "Documentary Photography" (1972); "Photography as a Tool" (1970). *Library of Life Photography*. New York, N.Y.: Time-Life Books.
- United States Department of the Interior, National Park Service. *Guidelines for Recording Historic Ships*. Washington, D.C.: U.S. Department of the Interior, National Park Service, Historic American Buildings Survey/Historic American Engineering Record Division, 1988.
- VIII. Wood Identification and Conservation**

- Amburgey, Terry L. *Annotated Bibliography on Preservation and Control of Decay in Wooden Structures*. Gulfport, Miss.: United States Department of Agriculture, 1971.
- Anon. *Nomenclature of Commercial Timbers, Including Sources and Supply*. London, Eng.: British Standards Inst., 1974.
- Department of the Navy. *Wood: A Manual for its use as Shipbuilding Material*. Kingston, Ma.: Teaparty Books, 1983.
- Hoadley, R. Bruce. *Understanding Wood: A Craftsman's Guide to Wood Technology*. Newton, Ct.: Taunton Press, 1980.
- Little, Elbert L., Jr. *1980 Checklist of United States Trees (Native and Naturalized)*. Washington, D.C.: Government Printing Office, 1980.
- Oddy, W.A., ed. *Problems of the Conservation of Waterlogged Wood*. Greenwich, Eng.: National Maritime Museum, 1975.

United States Forest Products Laboratory, Madison Wisconsin. *Wood Handbook: Basic Information on Wood as a Material of Construction With Data for its Use in Design and Specification*. Washington, D.C.: Government Printing Office, 1955.

United States Forest Service. *Wood Decay in Houses: How to Prevent and Control It*. Washington, D.C.: Government Printing Office, 1969.

IX. Oral History

Bartis, Peter. *Folklife and Fieldwork: A Layman's Introduction to Field Techniques*. Washington, D.C.: Library of Congress, American Folklife Center, 1979.

Baun, Willa K. *Transcribing and Editing Oral History*. Nashville, Tenn.: American Association for State and Local History, 1977.

Goldstein, Kenneth. *A Guide for Field Workers in Folklore*. Hatboro, Pa.: Folklore Associates, 1964.

Hoopes, James. *Oral History: An Introduction for Students*. Chapel Hill, N.C.: University of North Carolina Press, 1979.

Ives, Edward D. *The Tape-Recorded Interview: A Manual for Field Workers in Folklore and Oral History*. Knoxville, Tenn.: University of Tennessee Press, 1980.

Jolly, Brad. *Videotaping Local History*. Nashville, Tenn.: American Association for State and Local History, 1982.

Taylor, David A. *Documenting Maritime Folklife:*

X. Periodicals (Current and past)

American Canals. York, Pa.: American Canal Society.

American Neptune. Salem, Ma.: The Peabody Museum of Sharron.

Inland Seas. Vermillion, Ohio: The Great Lakes Historical Society.

Mariner's Mirror. London, Eng.: Society for National Research.

Maritime Life and Traditions. Brooklin, Me.: Woodenboat Publications.

Merchant Fleet News. Washington, D.C.: United States Shipping Board, Merchant Fleet Corporation.

Motor Boat. New York, N.Y.: Motor Boat Publications, Inc.

Motor Boating. New York, N.Y.: International Magazine Co.

National Fisherman. Camden, Me.: Journal Publications.

Nautical Research Journal. Washington, D.C.: Nautical Research Guild.

One Design Yachtsman. Chicago, Ill.: One Design Yachtsman, Inc.

Power Boating. Cleveland, Oh.: The Penton Publishing Co.

Rudder. New York, N.Y.: The Rudder Publishing Co.
Sea History. Croton-on-Hudson, N.Y.: National Maritime Historical Society.

Shipmodeler. New York, N.Y.: A.C. and H.W. Dickens.

Steamboat Bill. Providence, R.I.: The Steamship Historical Society.

An Introductory Guide, Washington, D.C., United States Naval Institute Proceedings. Annapolis, Md.: United States Naval Institute. Library of Congress

Woodenboat. Brooklin, Me.: Woodenboat Publications.

Yachting. New York, N.Y.: Yachting Publishing Corporation

CASE STUDY

HAER Historical Reports can be viewed online using the “Built in America” website of the Library of Congress at the following address:

http://memory.loc.gov/ammem/collections/habs_haer/

The following case study was written for illustrative purposes and is intentionally brief in order to save space and the user's time. An actual HAER study would be more in-depth, although time, money, and opportunity for research will govern report depth and length more than available research materials under some project conditions. This possibility, however, should not become an excuse for giving important vessels shallower treatment than their significance calls for. While this case study is reproduced in a two-sided format to save space, reports submitted to HAER must be produced on only one side of a page.

HISTORIC AMERICAN ENGINEERING RECORD

U.S. COAST GUARD CUTTER FIR
(WLM-212)

HAER No. WA-167

RIG/TYPE OF CRAFT: Cutter; originally lighthouse tender

TRADE: Tending aids to navigation, search and rescue (government)

OFFICIAL NUMBER: WLM-212

PRINCIPAL
DIMENSIONS: Length: 174'-8 1/2"
Beam: 32'
Draft: 11'-3"
Displacement: 885 tons

LOCATION: Puget Sound Area, Seattle Vicinity, King County, Washington

DATE OF
CONSTRUCTION: Keel laid on January 7, 1939
Launched on March 22, 1939

DESIGNER: U.S. Lighthouse Service

BUILDER: Moore Dry Dock Company
Oakland, California

ORIGINAL OWNER: U.S. Coast Guard

PRESENT OWNER: U.S. Coast Guard (to be decommissioned in 2002)
U.S. Coast Guard Headquarters
2100 Second Street, SW
Washington, DC

PRESENT USE: In storage in reserve fleet (to become museum ship)

SIGNIFICANCE: Designated a National Historic Landmark for her exceptional national significance, the FIR is the last surviving tender built under the U.S. Lighthouse Service. She was originally used to service and maintain lighthouses in the Puget Sound and along the

U.S. COAST GUARD CUTTER FIR

Washington coast. The FIR remained largely unchanged, and as such “represents a largely unheralded workaday-aspect of the lighthouse service, as well as the seafaring foundation from which the modern Coast Guard’s buoy tender fleet evolved.”¹

PROJECT
INFORMATION:

The United States Coast Guard Recording Program is part of the Historic American Engineering Record (HAER), a long-range program documenting significant engineering, industrial, and maritime sites in the United States. The HAER program is administered by the National Park Service, U.S. Department of the Interior. The FIR Recording Project was sponsored during 2000 and 2001 by the U.S. Coast Guard. Captain W. Patrick Lane, Chief, Office of Civil Engineering and Kebby Kelly, Environmental Officer served as liaisons.

The measured drawings, historical report, and photographs were prepared under the direction of Eric DeLony, Chief of HAER, and Todd Croteau, Maritime Program Manager. The team consisted of Pete Brooks, architect; Kevin Foster, Chief NPS Maritime Heritage Program; and Jet Lowe, photographer. Candace Clifford, historian, prepared the report, which was edited by Justine Christianson, HAER historian, NCSHPO.

¹ Ralph Shanks, “U.S. Coast Guard Cutter *Fir* (WLM 212) National Historic Landmark Study,” 1991, available at <http://www.cr.nps.gov/maritime/nhl/fir.htm>.

Table of Contents

FIR’s Statement of Significance4

Tenders in the Pacific Northwest.....4

Tenders at the Time of FIR’s Construction5

FIR’s Sister Ships6

Construction of FIR7

FIR’s Characteristics.....11

Original Equipment and Modifications12

FIR’s General Configuration13

FIR’s Operational History13

Decommissioning and Future Plans.....17

Bibliography18

FIR's Statement of Significance

FIR was designated a National Historic Landmark by the Secretary of the Interior on April 27, 1992, indicating that she is a property of exceptional national significance. Her summary of significance states,

The tradition of aids to navigation in the United States dates to colonial times. One of the first actions of the new federal government was the establishment of lighthouses. Often built on isolated and rugged shores, lighthouses required a special type of vessel to service and maintain them. These vessels were lighthouse tenders, which, with lightships were the only seagoing aspects of the lighthouse service. ... Laid down at the end of the tenure of the Lighthouse Service, *Fir* was transferred to the newly formed Coast Guard in 1939 when launched. Essentially unmodified, with the exception of re-engining, *Fir* is the last surviving unaltered American lighthouse tender, and the last working member of the U.S. Lighthouse Service fleet. *Fir* represents a largely unheralded workaday-aspect of the lighthouse service, as well as the seafaring foundation from which the modern Coast Guard's buoy tender fleet evolved.²

Tenders in the Pacific Northwest

The first revenue cutter dispatched to the Pacific Northwest was the topsail schooner JEFFERSON DAVIS, which sailed into Puget Sound on September 28, 1854. The first lighthouse tender to serve the Pacific coast was SHUBRICK, a wooden-hulled sidewheeler built in Philadelphia in 1857. After arriving on the West Coast, she assisted in the construction of the first lighthouses in Washington Territory. She served double duty as a buoy tender and a revenue cutter, carrying three 12-pound cannons and small arms. SHUBRICK serviced the entire Pacific coast until 1880, when a second vessel, MANZANITA was assigned to assist. SHUBRICK continued to serve the lower Pacific coast, while MANZANITA worked the northwest portion of the coast. As traffic increased in Northwest waters, so did the need for aids to navigation, and MANZANITA was joined by COLUMBINE, a U.S. Army Engineers vessel, to help maintain the increasing number of aids. After MANZANITA sank in the Columbia River off Warrior Rock, Oregon, a second MANZANITA was constructed.³

When the Coast Guard took over the Lighthouse Service, the Thirteenth District had four tenders in service: HEATHER, ROSE, MANZANITA, and RHODODENDRON. Upon the arrival of

² Shanks, "U.S. Coast Guard Cutter *Fir* (WLM 212)."

³ "History of the District Coast Guard Vessel Operations Office, Thirteen Naval District," written and prepared by Vessel Operations Office under direction and supervision of District Historical Office, 1945, 7; and Dennis Noble, "The Coast Guard in the Pacific Northwest," available at http://www.uscg.mil/hq/g-cp/history/h_PacNW.html.

FIR, HEATHER was removed from duty. She was later loaned to the Army for war service and never returned.⁴ Two tenders were commissioned and assigned to the Thirteenth Naval District during World War II: BASSWOOD and BLUEBELL. The tenders performed regular duties during the war but were equipped with small arms, depth charge racks, and deck guns for protection against enemy submarines.⁵

The hazardous nature of work on the Northwest tenders during the 1940s was described as follows:

The jobs confronting the buoy tenders were much the same—relieving buoys annually, replacing and recharging batteries, installing acetylene accumulators, and establishing new aids. The routine, however, was never monotonous. Treacherous waters, dangerous shoals, fog, storms, and the nature of the equipment made the task of the buoy man a hazardous as well as a highly specialized operation. Winter activities were especially grueling, as sharp winds blew icy water on the men as they worked, while the rolling ship with its slippery deck made each movement a hazardous one.⁶

Tenders at the Time of FIR's Construction

The Engineer's Digest of September 1939 included the following description of a lighthouse tender:

Lighthouse Tenders are used for general duty which consists mainly of servicing navigational aids and supplying necessities to lighthouses and lightships. In order to perform these duties the vessel must be able to carry personnel, cargo, fuel and water. In addition to the above, the vessel must have adequate deck space for working, storing and servicing buoys. In order to lift the buoys with their chains and sinkers, the vessels are equipped with derricks of a capacity commensurate with the size and duties of the vessel. In order that the buoys may be worked alongside, with reasonable safety to personnel, low freeboard is essential. The large tenders are equipped with booms approximately fifty feet long with a working capacity of twenty tons. The vessels are of medium speed, in general rather shoal draft, and are usually twin screw due to the requirement of handling heavy weights over the side, coupled with a low freeboard requirement. The larger tenders are designed for open sea work, a smaller type being used for bays and

4 U. S. Coast Guard Thirteenth Naval District, "History of the United States Coast Guard Thirteenth Naval District 1917-1945," 23. On file at the National Archives, Seattle, Washington.

5 Aids to Navigation Office, District Historic Office, Thirteenth U.S. Coast Guard District, "History of Aids to Navigation Office, United States Coast Guard, Thirteenth Naval District"; and Noble, "The Coast Guard in the Pacific Northwest."

6 "History of the District Coast Guard Vessel Operations Office," 8.

sounds, and still smaller type for protected waters. Vessels are powered with steam, diesel, and diesel-electric drives.⁷

In 1940 the U.S. Coast Guard had to maintain a grand total of 30,420 aids to navigation in U.S. waters. These included lighted aids (lighthouses, lightships, and buoys), fog signals, unlighted buoys, and daymarks.⁸ In the Thirteenth U.S. Coast Guard District, which included Washington and Oregon, it was reported that at the time of consolidation in 1939, there were 1,362 aids to navigation, including “31 major light stations, four lightships, 133 fog signals, 12 radiobeacons, 672 minor light station including lighted buoys, and 676 unlighted buoys and daymarks.”⁹

FIR’s Sister Ships

FIR was part of the HOLLYHOCK class, a three-ship class designed as coastwise (type “A”) tenders for use by the Lighthouse Service. The first ship of the class, HOLLYHOCK, was contracted in March 1936, launched on March 24, 1937, and commissioned on August 7, 1937. Constructed by the Defoe Boat & Motor Works, of Bay City, Michigan, HOLLYHOCK was built to replace the aging U.S. Lighthouse Tender SUMAC. HOLLYHOCK was first assigned to duty in the Twelfth Lighthouse District and was homeported in Milwaukee, Wisconsin. She was designated WAGL-220 at the start of World War II. HOLLYHOCK worked out of Detroit, Michigan, from 1959 to 1962, and Miami, Florida, from 1962 until she was decommissioned from the U.S. Coast Guard on March 31, 1982. She was sold and served for a time as GOOD NEWS MISSION SHIP. She was sunk as an artificial reef off Pompano Beach, Florida, in 1990.¹⁰ Prior to decommissioning, HOLLYHOCK’s engine room and steam engine were removed and are now on display at the Smithsonian Institution’s Museum of American History in the Transportation Department.

The third sister ship, WALNUT, was contracted to the same shipyard as FIR and was launched in the same month on March 18, 1939. WALNUT, however, was commissioned on June 27, 1939, more than 15 months before FIR. Replacing U.S. Lighthouse Tender MARIGOLD, WALNUT serviced aids to navigation on Lake Huron and Lake Superior until June 1941, when she was reassigned to the Hawaii Territory. Designated WAGL-252 in January 1942, WALNUT was redesignated WLM-252 in January 1965. WALNUT was assigned to Miami, Florida, from 1954 to 1967, and San Pedro, California, from 1967 until she was decommissioned from the U.S.

U.S. COAST GUARD CUTTER FIR
HAER No. WA-167

7 U.S. Coast Guard Division of Engineering, “Construction and Repair Topics,” *The Engineer’s Digest* (September 1939).

8 Treasury Department, U.S. Coast Guard, *The United States Coast Guard: General Information* (Washington, D.C.: 1941), 28.

9 “History of United States Coast Guard Thirteenth Naval District,” 21.

10 Douglas Peterson, U.S. Coast Guard (Ret), *United States Lighthouse Service Tenders 1840-1939* (Annapolis, Maryland: Eastwind Publishing, 2000), 137-138.

Coast Guard in 1982. In July 1982, WALNUT was transferred to the government of Honduras and was renamed YOJOA (FNH-252) in 1989.¹¹

Construction of FIR

The Moore Dry Dock Company, a shipyard located at the foot of Adeline Street in Oakland, California, was the site of the construction of FIR. The contract was let by the U.S. Lighthouse Service on August 17, 1938. The cost of construction was \$389,746, which was covered by funding from the Public Works Administration (PWA). Additional fittings, however, brought the price closer to \$400,000.¹² Plans for the previously built sister ship, HOLLYHOCK, were used as the contract plans for FIR.¹³ F. C. Hingsburg, the Superintendent of Lighthouses in Portland, Oregon, noted,

The design of the FIR has been reviewed with interest, but no changes are indicated for her operation in this district as this question has not been raised by the Bureau. There are no spare state rooms for keeper or lightship personnel when making patrols for supplying outlying stations and carrying liberty parties. Some of the state rooms are small and valuable space is taken up with 4 ft. berths. These could well be standard single width size, 3'-6" x 6'-6" to take standard mattresses and bedding sheets and give some additional room space. It is noted that the forecastle is in the old style arrangement with sixteen men occupying crews space and not in keeping with modern trends on new ships.¹⁴

Correspondence in April 1939 indicated that additions and changes were made to some of the quarters aft in the main and upper decks.¹⁵

U.S. COAST GUARD CUTTER FIR
HAER No. WA-167

11 Peterson, *United States Lighthouse Service Tenders*, 137-138.

12 "Trials of New Lighthouse Tender 'Fir' held at Oakland, Calif," *Coast Guard Bulletin* 1, no. 2 (August 1939); Peterson, *United States Lighthouse Service Tenders*, 137.

13 Correspondence to the Commissioner of Lighthouses, Washington, D.C., from R. R. Tinkham, Chief Engineer, Lighthouse Service, Portland, Oregon, dated April 8, 1939, National Archives, Record Group 26, Entry 50, "Correspondence of the Bureau of Lighthouses, 1911-1939," subject file 4231E (hereafter cited as Record Group 26, Entry 50). Letter indicates the contract plans as numbers 24092, 24093, 24094, 24095, 24096, and 23820. Original plans for HOLLYHOCK were found in Record Group 26 at the National Archives but none were found for FIR.

14 Correspondence to the Commissioner of Lighthouses, Washington, D.C., from F. C. Hingsburg, Superintendent of Lighthouses, Portland, Oregon, dated September 17, 1938, National Archives, Record Group 26, Entry 50.

15 Correspondence to the Commissioner of Lighthouses, Washington, D.C., from R. R. Tinkham, Chief Engineer, Lighthouse Service, Portland, Oregon, dated April 8, 1939, National Archives, Record Group 26, Entry 50.

The first available progress report for work completed on FIR during October 1938 listed 133 workers completing 3,642 hours on the project. In November 1938, the number of workers had increased to 311, logging 8,010 1/4 hours. Seventy-five percent of the frames had been laid out, and 5 percent were riveted. Cast-iron work had been started by the Phoenix Iron Works, and brass castings had been received from the Oakland Brass Foundry. In December 1938, the number of workers had increased to 515, logging 16,299.57 hours. By December, the keel was 90 percent fabricated, with the stern frame cast on December 30. The frames and reverse frames had been 90 percent riveted, the loftwork had been completed, and the floors had been assembled and riveted. The stringers, side keelsons, built-in fuel tanks, lower and main deck beams and plating had also been fabricated. Lighthouse Service Inspector W. H. Griffin noted, "Marine Ways are fitted for laying keel January 2. Fabrication and assembly of steel keeps well up with first ship 'Walnut'. Laying of this keel will make for better work by doing away with most of the last minute work on first vessel."16

FIR's keel was laid on January 7, 1939. The progress report for January 1939 indicated there were 788 workers on the payroll, logging 31,332.72 hours. The stem was in place with the cant framing and floors completed. The upper deckhouse, pilothouse, and radio room were being fabricated, while the main deckhouse, including divisional bulkheads, was being erected. Inspector Griffin remarks, "Work on Tender 'FIR' has gone ahead well for the time under way. Riveting and welding of hull following well up to erection of steel. Struts for this vessel up for inspection at Columbia Steel Plant tomorrow. Moxley Boilers received January 27th, 1939. ..."17

The February 1939 progress report indicated that the number of workers had increased to 1,287 workers, logging 57,229 hours. Most work was done primarily below the main deck. The hull was close to completion with fuel, freshwater, and ballast tanks finished, and bulkheads had been completed below the main deck. Some delays were reported due to the late arrival of materials, such as wrought iron pipe and lumber for the fenders.18

U.S. COAST GUARD CUTTER FIR
HAER No. WA-167

16 Quote from attachment to report dated December 31, 1938; progress reports to the Commissioner of Lighthouses, Washington, D.C., from Lighthouse Service Inspector W. H. Griffin, Oakland, California, are found in National Archives, Record Group 26, Entry 50.

17 Progress reports found in National Archives, Record Group 26, Entry 50.

18 Progress reports found in National Archives, Record Group 26, Entry 50.

FIR was launched at the Moore Dry Dock Company Shipyard on March 22, 1939.¹⁹ Her sponsor, Harriet Birta Mason of Sacramento, California, was the daughter of Major General Wallace A. Mason, a good friend and “war comrade” of Assistant Secretary of Commerce J. M. Johnson.²⁰ During the month FIR was launched, the number of workers was reduced to 836, logging 37,206 hours. The boilers were installed, as well as the steering engine, chain lockers, sea chests, and all tanks.²¹

The progress report for April 1939 reveals that the number of workers was further reduced to 498 workers, who logged 37,643.12 hours. The workers completed all deck machinery including hoisting engine and control gear, anchor windlass and chain stoppers, boat hoister, and capstan. All pumps and fuel oil heaters were installed, as well as chain and lamp lockers and store rooms forward and aft. Inspector Griffin remarked, “Vessel hauled out on Marine Ways to complete testing and painting. Hull work is about complete. Wheels and rudder installed. Auxiliaries being installed. Boilers tests and work going smoothly although falling back a little.”²²

The May 1939 report listed 210 workers who logged in 30,809 hours. Nearing completion was the installation of cork in the quarters for the superintendent, officers, and crew. In the main deck, upper deck, and pilothouse, windows had been installed, while outside and inside doors and hardware installation had also been finished. The davits, foundations, and chocks for boats were completed, as well as the steering gear engine, rudder, quadrant, and arrangement. The main engines, hand gear, stern tubes, propeller struts, bearings, line and propeller shafting were completed in the shop. The propellers, condenser, and feed water heater with grease extractor had been installed on the ship. The inspector noted, “Vessel to undock June 6th, mast and engines to be installed next day. All work progressing satisfactory and no doubt of keeping delivery dates.”²³

The last progress report on file is for June 1939. The 162 workers, logging 23,767 hours, installed furniture, completed installation of air ports and lights, and installed fire extinguishers. Furthermore, components of the electrical system were either in the yard or had been installed,

U.S. COAST GUARD CUTTER FIR
HAER No. WA-167
(Page 10)

¹⁹ Telegram from Inspector Griffin, dated March 22, 1939, National Archives, Record Group 26, Entry 50. According to correspondence dated March 30, 1939, from the Superintendent of the Eighteenth District to the Commissioner of Lighthouses, the launching of FIR was postponed from March 18 until March 22 because a chain of the marine railway was found to be broken.

²⁰ Correspondence from J. M. Johnson to Wallace A. Mason, dated February 21, 1939, National Archives, Record Group 26, Entry 50.

²¹ Progress reports found in National Archives, Record Group 26, Entry 50.

²² Progress reports found in National Archives, Record Group 26, Entry 50.

²³ Progress reports found in National Archives, Record Group 26, Entry 50.

and 75 percent of the telegraph system, bells and pulls, electric bells, alarm and ships bell had been completed. Cementing of tanks and bilges was listed as being complete, and the piping systems were close to completion. Skylights were installed but not tested. Ventilation of the engine room, fire room, officers quarters, and crews quarters was 80 percent complete. Derrick mast and boom, as well as standing and running rigging, main mast, ensign and jack staff, had been finished. Painting of the underwater body and boot topping had been completed and was well underway for the exterior of the hull above the waterline, superstructure, quarters, and pilothouse. Red lead paint was used on machinery casing and radio room, galley, and engine room. Anchors, cleats, chocks, freeing ports, hand rails, grab rails, and ladders were complete or close to completion.²⁴

Although launched under the U.S. Lighthouse Service, the vessel was completed under the U.S. Coast Guard, making her the last U.S. Lighthouse Service tender constructed.²⁵ Trials were held on San Francisco Bay on August 17, 1939.²⁶ The Trial Board consisted of R. R. Tinkham, Chief Lighthouse Engineer, Portland, Oregon; W. C. Dibrell, Superintendent of Lighthouses, Ketchikan, Alaska, with F. C. Hingsburg, Superintendent of Lighthouses, Portland, Oregon, acting as his alternate; and F. H. Conant, Assistant Lighthouse Engineer, San Francisco, California.²⁷ The following day, August 18, 1939, the FIR departed for Portland, Oregon. On December 30, 1939, she received orders to proceed to Lake Washington, Seattle, Washington.²⁸ She was commissioned as the U.S. Coast Guard Cutter FIR (WAGL-212) on October 1, 1940.

FIR was outfitted with several small boats: a 24' cargo boat on the starboard side, a 26'-3" surf boat on the port side, and a 17'-3" powered dinghy on the upper deck, port side.²⁹ FIR was also equipped with a radiotelephone as part of the PWA project; radio equipment was ordered from the General Lighthouse Depot in New York.³⁰ In addition, FIR was outfitted with a deep-water "Type 480" fathometer.

U.S. COAST GUARD CUTTER FIR
HAER No. WA-167
(Page 11)

²⁴ Progress reports found in National Archives, Record Group 26, Entry 50.

²⁵ The Lighthouse Service was consolidated under the U.S. Coast Guard on July 1, 1939.

²⁶ "Trials of New Lighthouse Tender 'Fir'."

²⁷ Memo from H. D. King, Commissioner of Lighthouses, dated May 25, 1939, National Archives, Record Group 26, Entry 50.

²⁸ Dispatches from Fowler to Headquarters, dated August 18, 1939, and from Commander, Seattle District to Lighthouse Tender FIR, dated December 30, 1939, National Archives, Record Group 26, Entry 283B, "U.S. Coast Guard General Correspondence, 1936-41."

²⁹ Correspondence to the Commissioner of Lighthouses, Washington, D.C., from F. C. Hingsburg, Superintendent of Lighthouses, Portland, Oregon, dated September 17, 1938, National Archives, Record Group 26, Entry 50.

³⁰ Memo to F. C. Hingsburg, Superintendent of Lighthouses, Portland, Oregon, from G. F. Ganong, Assistant Superintendent, dated December 12, 1938, and correspondence to Hingsburg from Deputy Commissioner C. A. Park, dated December 27, 1938, National Archives, Record Group 26, Entry 50.

Specifications indicated that

the equipment will comprise all necessary units, including cable and ship fittings as necessary to provide continuous, direct reading, automatic depth indications by echo sounding principles, on board Lighthouse Tenders in the U.S. Lighthouse service. Major units will include an indicator, a receiver-amplifier, an impact oscillator, a resistance unit, and two hydrophones with a hydrophone tank. The fathometer will indicate depths in coastal, lake, or river waters, but to obtain the guaranteed accuracy, the motor speed must be adjusted to suit the salinity and temperature of the water in which observations are being made or suitable corrections must be made to the observed depths. The maximum power drawn from the line will be about 800 watts, but the average power will be about 400 watts at 110-115 volts.³¹

Two bow ornaments costing \$28.00 each were ordered on December 30, 1938. Nine marine clocks, two ensign flags, one signal flag, the 1939 *American Nautical Almanac*, *U.S. Coast Pilot*, *Pacific Coast*, *International Code of Signals*, and Bowditch's *American Practical Navigator* were also requisitioned.³²

FIR's Characteristics

FIR is 174'-8 1/2" in overall length, 32' in breadth, 11'-3" in draft, and displaces 885 tons. Measurements at decommissioning were the same, except the extreme beam was listed as 34' and her length between perpendiculars as 163'-6". Her hull is steel, and her superstructure is steel and wood. Her propulsion is twin screw and, when launched, she had two triple-expansion steam engines. Her Diesel engines at decommissioning were two four-cylinder Fairbanks-Morse 38D 8-1/8, with a shaft horsepower of 1,350, and two Detroit Diesel 100KW generators. She had a maximum cruising speed of 12 knots or a radius of 1,824 nautical miles. Her normal complement was six officers and twenty-four enlisted men, which increased to forty-one enlisted men during wartime. In 1991, she had four officers, two warrants, and thirty-five enlisted men.³³

U.S. COAST GUARD CUTTER FIR
HAER No. WA-167
(Page 12)

Original Equipment and Modifications to FIR

31 Memo to Hingsburg from Ganong, and correspondence to Hingsburg from Park, National Archives, Record Group 26, Entry 50.

32 National Archives, Record Group 26, Entry 50.

33 The old statistics come from the vessel card on file at U.S. Coast Guard Historian's Office, Washington, D.C., and the new statistics come from the Decommissioning Ceremony program, October 1, 1991.

FIR began her career equipped with two triple-expansion horizontal steam engines (1,000 combined steam horsepower) and two oil-fired Babcock and Wilcox watertube boilers. Her steel boom with hydraulic hoist had a 20-ton capacity.³⁴ During an overhaul and conversion at the Todd Shipyard, in Seattle, Washington, from February 1 to October 1, 1951, FIR was re-engined from steam to diesel with twin 1,350-horsepower Fairbanks-Morse diesel engines coupled with reduction gears. She was the last American steam-powered tender to be dieselized.³⁵ In 1974, two maneuvering rudders were added to improve her shiphandling. In 1982, a new hydraulic boom and A-frame system³⁶ replaced the old electrically powered one, giving her the 30,000-pound hoisting capacity needed to work the 9' buoys and 9-ton sinkers found off the coast.³⁷ Her electronics package was modernized during her career, so that by the time of her decommissioning, she had five computer work stations, two radar, a variety of receivers and transmitters, a thermal imaging scope for damage control, and a computerized telephone system.³⁸

The living spaces were modified in the late 1980s to provide a four-rack berthing area for female crew.³⁹

Despite the modifications that were necessary for continued operation, FIR retains much of her original character and many of her original features, making her a unique legacy to the Lighthouse Service as described in the 1991 decommissioning booklet.

Oak bannisters adorn the ladders, polished brass is throughout the bridge, many staterooms have the original wooden racks, desks, and wardrobes, and screen doors still open onto the weather decks. She has a classic lighthouse tender design, including a white pine “rub” rail 2 feet above the waterline, a spacious bridge with curved windows which roll down, outboard passageways on the maindeck, skylights in the engine room, and windows in the staterooms and engineroom looking out into the passageway.⁴⁰

U.S. COAST GUARD CUTTER FIR
HAER No. WA-167
(Page 13)

34 Peterson, *United States Lighthouse Service Tenders*, 137-138.

35 James Gibbs, *Sentinels of the North Pacific* (Portland, Oregon: Binford & Mort, 1955), 112.

36 The system was removed from U. S. Coast Guard Cutter CITRUS according to “FIR Celebrates 50th,” *Commandants Bulletin* (January 1991), 18.

37 FIR needed these improvements in order to meet operational needs faced by WALNUT which she would be replacing.

38 “USCG FIR (WLM-212),” decommissioning booklet, 1991.

39 “USCG FIR (WLM-212).”

40 “USCG FIR (WLM-212).”

FIR's General Configuration⁴¹

Starting below the waterline and working up, FIR's hold and lower deck, moving aft forward, consist of the rudder, auxiliary rudder, steering gear room above after peak tank, crew's berthing above aft freshwater tanks, auxiliary engine room, main engine room, fuel tanks, workshop, main hold, more crew's berthing above the boatswain's locker and forward freshwater tanks, chain locker and forepeak tank. The engine room contains the twin Diesel engines that replaced the steam engines in 1951, as well as two generators for electricity while underway and boilers for heat.

Next, the main deck consists of the rear bulwarks, officers' quarters, linen locker, commanding officer's locker, sick bay, upper engine room, galley and mess. Outside are the king post supporting the hoisting mechanism, cargo hatch, buoy port, crew's wardroom, and paint locker. The upper deck includes davits anchoring two lifeboats, boat winch, main mast, staterooms, engine room trunk, offices, uptakes for funnel, wardroom, and the topping winch and boom of the hoisting mechanism. The officers' stateroom is relatively large and contained wooden furniture and a screen door leading to the boat deck. The wardroom, where the officers ate and worked, is unusual for cutters in that it offers a view of the buoy deck. The forecastle deck includes various vents and the anchor windlass.

The wheel house, with the control house for the hoisting mechanism above, occupies the bridge deck level. Bridge equipment includes the helm controlling three hydraulic rudders, radar, radio, engine controls for twin shafts both port and starboard, gyro and magnetic compass, searchlight controls, captain's chair, and voice tube to flying bridge. Both windows and balcony provide a view of the buoy deck.

FIR's Operational History

With the exception of a short stint in Long Beach, California, where she temporarily replaced WALNUT after her decommissioning in 1982, FIR spent her entire career operating out of Seattle, Washington. At the start of her career, FIR relieved the old U.S. Lighthouse Tender HEATHER⁴² of her duty tending aids in the Puget Sound area. She reported for duty at the Coast Guard Buoy Repair Depot in Salmon Bay near the Ballard Locks. The *Seattle Times* reported on June 9, 1940, that she was "one of the most modern vessels of her type," with both a gyro stabilized compass and a radio direction finder. Within a month of the article's publication, a depth sounder was installed, completing the state-of-the-art electronics package.⁴³

U.S. COAST GUARD CUTTER FIR
HAER No. WA-167
(Page 14)

⁴¹ This section is based on a three page outline entitled "FIR TOUR NOTES" found in the FIR's vessel file at the U.S. Coast Guard Thirteenth District Offices in Seattle, Washington, and on her set of drawings.

⁴² Peterson says FIR replaced MARIGOLD, but other sources indicate HEATHER.

⁴³ "USCG FIR (WLM-212)."

FIR started her career under the command of Chief Warrant Officer Ole Eriksen, a seasoned Lighthouse Service master who had last served on HEATHER. FIR's duties included resupplying coal, potable water, food, and other vital provisions to lightships and lighthouses in the Strait of Juan de Fuca and on the Washington coast. FIR also transported personnel on and off these remote stations and delivered mail and personal goods. In addition to servicing the manned aids, FIR maintained the automated acetylene buoys throughout the waters of northwest Washington.⁴⁴

In 1940, there were at least 21 active light stations in Washington waters: Admiralty Head, Straits of Juan de Fuca, Puget Sound; Alki Point, Elliott Bay, Puget Sound; Browns Point, Commencement Bay, East Entrance, Puget Sound; Burrows Island, Rosario Strait; Cape Disappointment, Columbia River mouth; Cape Flattery, Tatoosh Island at the entrance to Strait of Juan de Fuca; Destruction Island; Grays Harbor, south entrance to Grays Harbor; Lime Kiln, Dead Mans Bay, San Juan Island; Marrowstone Point, Admiralty Inlet; Mukilteo, east side of Possession Sound; New Dungeness, Admiralty Island, Strait of Juan de Fuca; North Head, Columbia River mouth; Patos Island, Straits of Georgia, Puget Sound; Point No Point, Kitsap Peninsula, Puget Sound; Point Robinson, East End Maury Island, Puget Sound; Point Wilson, entrance to Admiralty Inlet, Puget Sound; Slip Point, Clallam Bay, Strait of Juan de Fuca; Smith Island, Strait of Juan de Fuca; Turn Point, Prevost Harbor, Stuart Island; and West Point, Elliott Bay, Puget Sound.⁴⁵ Several were remote offshore light stations where the transfer of personnel was often a dangerous and time-consuming task, as exemplified at Cape Flattery, Washington, where

keepers had to be hoisted by derrick onto the island in an open box dangling from a hook. A small boat had to be worked in under the box as personnel were transferred, sometimes under rough sea conditions. *Fir*, like other tenders, had to routinely go into water where no other type of boat dared venture.⁴⁶

FIR also served three lightship stations: SWIFTSURE BANK at the entrance to the Strait of Juan de Fuca; UMATILLA REEF off La Push; and COLUMBIA at the mouth of the Columbia River at the Washington-Oregon border.⁴⁷

During World War II, FIR was placed under the direction of the Navy and painted grey. Her armament installed included 50-caliber machine guns, one 3-inch gun, and depth charges. Her

U.S. COAST GUARD CUTTER FIR
HAER No. WA-167
(Page 15)

⁴⁴ "USCG FIR (WLM-212) ."

⁴⁵ National Park Service Inventory of Historic Light Stations, surviving stations, available at <http://www.cr.nps.gov/maritime/lsum.htm>.

⁴⁶ Shanks, "U.S. Coast Guard Cutter *Fir* (WLM 212)."

⁴⁷ Shanks, "U.S. Coast Guard Cutter *Fir* (WLM 212)."

war duties included standing picket duty, towing gunnery targets, and patrolling in and around Washington and Oregon waters.⁴⁸ Since Coast Guard cutters were rare in the Thirteenth District “during the war, a vast amount of assistance work fell upon the tenders. The increased size of the fishing fleet had the effect of causing more rescue operations, and in these, the tenders did an extraordinarily fine job.”⁴⁹

After the war, FIR returned to her regular routine tending the many buoys marking Washington’s waterways.

Maintaining and servicing buoys means long hours of hard, often dangerous work. The buoy’s anchor, tons of cement with chain attached, hangs suspended alongside her low buoy deck. Taking continuous bearings, the ship maneuvers into the exact position matching the buoy’s charted location. On command, the huge anchor is released and plunges to the bottom of the sea, pulling row after row of heavy chain, clattering off the steel decks after it. The freshly painted and serviced buoy, laying on its side on deck, is then hoisted aloft with the boom, swung over the side and released. The ship backs away and another aid to navigation is back on the job.

Initially the bearings were taken with lead line and sightings from the bridge deck. Now Global Position System satellites provide much more accurate, and quicker fixes. The buoys, once lighted with acetylene, were updated to storage batteries and then to solar power. FIR lived long enough to witness these transitions over the years.⁵⁰

In addition to servicing aids to navigation, FIR performed search and rescue, marine environmental protection, and law enforcement. Search and rescue missions included rescuing nineteen people off the distressed MV ANDALUCIA, which had caught fire off of Neah Bay on November 4, 1949; assisting MV BELIOT VICTORY near Destruction Island on April 30, 1952; escorting USS YUMA, which had developed trouble while towing USS TINIAN six miles south of Swiftsure Bank on February 19, 1958; and assisting in the search for a downed navy aircraft in Guemes Channel on March 14, 1963. Recovery and salvage missions included salvaging a CG HO4S helicopter and delivering it to Port Angeles on November 11, 1962, and assisting in the recovery of a USAF T-34 aircraft on July 16, 1965. FIR also helped fight a fire at the Todd Shipyard in Seattle on November 28, 1968. Her last dramatic rescue occurred on July 5, 1990, when FIR saved the life of a mariner trapped on the bow of a burning pleasure boat on Shilsole Bay, extinguishing the fire and saving the boat. FIR also participated in recreational activities, such as patrolling the Maritime Day tugboat races in Elliott Bay on March 22, 1954, and the Lake

U.S. COAST GUARD CUTTER FIR
HAER No. WA-167
(Page 16)

48 “USCG FIR (WLM-212).”

49 “History of United States Coast Guard Thirteenth Naval District,” 24.

50 Charles W. Lindenberg, “TAPS FOR THE FIR,” published on Jack’s Joint web site <http://www.jacksjoint.com/fir.htm>.

Washington Gold Cup Regatta August 9 -11, 1958. In June 1972, she transported 600,000 Chinook salmon fry to Squaxin Island to seed the local waters.⁵¹

In the 1980s, FIR assisted in the aftermath of two major oil spills. She was awarded a Unit Commendation for her work after the 833' ARCO ANCHORAGE grounded in Port Angeles, spilling 239,000 gallons of crude oil in 1985. After the EXXON VALDEZ went aground in 1988, FIR conducted the regular duties of U.S. Coast Guard Cutter IRIS so that IRIS could assist with the cleanup.⁵²

As part of the Coast Guard's reclassification system, FIR was redesignated a Coastal Buoy Tender (WLM-212) in 1965. The only mishap listed on a table compiled by the Cutter Operations Division in late 1990 is that FIR "grounded" on July 15, 1965, suffering minor damage.⁵³

After a thorough inspection in 1985 identified the need for major repairs, restrictions were placed on FIR's coastal operations:

The vessel has been prohibited, at least temporarily, from servicing 9' buoys, and she is required to observe certain loading conditions while servicing 8' buoys. Her hull form is unusually susceptible to synchronous rolls.

Since *Fir*'s usefulness is limited in exposed waters, a second WLB would be a more suitable vessel for performing ATON work in this district. The Seattle tender is required to respond to discrepancies along the coast whenever the Astoria tender is in a maintenance status; furthermore, it would be desirable to more evenly distribute the coastal ATON and ELT workload by routinely assigning the Seattle tender to duties along the coast.⁵⁴

Repairs extended FIR's life for another four years, but the next cycle of repair work had a price tag of more than \$2.5 million and would not have extended her service life beyond 1995.⁵⁵ Many felt it would be more cost effective to replace her with a modern tender.

U.S. COAST GUARD CUTTER FIR
HAER No. WA-167
(Page 17)

51 "USCG FIR (WLM-212)"; and Shanks, "U.S. Coast Guard Cutter *Fir* (WLM 212)."

52 "USCG FIR (WLM-212)."

53 "Major USCG Cutter Accidents" compiled by the U.S. Coast Guard Historian's Office, available at <http://www.uscg.mil/hq/g%2Dcp/history/cutteraccidents.html>.

54 Memo dated February 5, 1986, to the Commandant from the Commander of the Thirteenth Coast Guard District, in Coast Guard Historian's office, Washington, D.C.

55 Report in the vessel file, entitled "USCG FIR (WLM 212) REPAIRS"; according to her file in the U.S. Coast Guard Thirteenth District office, FIR was last drydocked in 1988.

When U.S. Coast Guard Cutter INGHAM was decommissioned on May 27, 1988, FIR became the Coast Guard's oldest cutter and was designated "Queen of the Fleet." She received gold hull numbers on May 30, 1988, for this distinction. Her durability may in part have been due to the fact that she served in a freshwater environment with limited exposure to heavy seas, although the loving care provided by her captain and crew no doubt also played a role.⁵⁶

Before decommissioning in 1991, FIR was responsible for 138 lighted and unlighted buoys in the Strait of Juan de Fuca and the Puget Sound area.⁵⁷ In the spirit of her original mission, FIR's last active-duty assignment was assisting in the rehabilitation of Cape Flattery Lighthouse on Tatoosh Island at the entrance of the Strait of Juan de Fuca.⁵⁸

Decommissioning and Future Plans

FIR was decommissioned on October 1, 1991, one year after her fiftieth birthday. Over 600 attendees were on hand to honor the last surviving lighthouse tender in the United States. The oldest commissioned cutter award was presented to CDR Philip E. Sherer, Commanding Officer of the U.S. Coast Guard Cutter STORIS, by FIR's commanding officer, LCDR Nutting. A decommissioning booklet was prepared to pay tribute to FIR. In describing her career, the booklet states,

Through her 51 years, FIR's primary responsibilities of maintaining aids to navigation have remained the same. She has adapted to the major technological advances of the past five decades while still retaining the heritage of her Lighthouse Service days. During her career, she saw the power used to light buoys change from acetylene to solar while the hulls [of tenders] changed from riveted construction to steel or foam. She saw the art of positioning buoys advance from lead line and seaman's eye to computerized plotting and satellite positioning. She has also seen the replacement of lightships with large navigational buoys and light keepers by automated lighthouses.⁵⁹

The Commander of the Thirteenth Coast Guard District stated that upon her decommissioning,

The physical condition of the FIR is excellent. She has been maintained in extraordinary condition for a vessel of her age and is, therefore, an ideal candidate for historic

U.S. COAST GUARD CUTTER FIR
HAER No. WA-167
(Page 18)

⁵⁶ Memo dated June 18, 1985, from Lieutenant Marvel to file regarding SSMEB USCGC FIR 10-14.

⁵⁷ "FIR Celebrates 50th," 18.

⁵⁸ "USCG FIR (WLM-212)"; LTJG Mark Wilcox, "FIR's Last Trip," *Aids to Navigation Bulletin*, Winter 1997/1998 (U.S. Coast Guard National ATON school at Reserve Training Center, Yorktown, Virginia), 4. See

www.uscg.mil/hqltrc/atonblt/winter98/minor.htm.<http://www.uscg.mil/hqltrc/atonblt/winter98/minor.htm>.

⁵⁹ "USCG FIR (WLM-212)."

preservation. As a floating museum, she would provide an excellent opportunity for visitors of all ages to learn a little about the maritime history of Puget Sound. Virtually all areas of the ship including the engineroom, living quarters, galley and buoy deck are readily accessible from the main deck. The pilothouse has beautiful woodwork and brass appointments.⁶⁰

After decommissioning, FIR remained in Seattle for many years while efforts were made to turn her into a floating museum. When these efforts failed, she was transferred to the Maritime Administration (MARAD) facility, Suisun Bay, California, in 1997. Her shafts and rudder locked, the U.S. Coast Guard Cutter MARIPOSA towed FIR 930 miles from Seattle to San Francisco's Golden Gate where she was met by a commercial tug that towed her the rest of the way to Suisun Bay.⁶¹ Significant objects were removed from the vessel and stored at the U.S. Coast Guard facility in Forestville, Maryland. At the end of 2001, FIR remains in storage in the Reserve Fleet in Suisun Bay. As of 2001, the U.S. Coast Guard is seeking a new caretaker for the vessel who will preserve and interpret her to the public.

Bibliography

Aids to Navigation Office, District Historic Office, Thirteenth U.S. Coast Guard District.

“History of the Aids to Navigation Office, United States Coast Guard, Thirteenth Naval District.”

“FIR Celebrates 50th,” *Commandants Bulletin* (January 1991).

Gibbs, James. *Sentinels of the North Pacific*. Portland, OR: Binford & Mort, 1955.

“History of the District Coast Guard Vessel Operations Office, Thirteen Naval District.” Written and prepared by Vessel Operations Office under the direction and supervision of the District Historic Office, 1945.

Lindenberg, Charles W. “TAPS FOR THE FIR.” Published on Jack's Joint website, available at <http://www.jacksjoint.com/fir.htm>.

“Major USCG Cutter Accidents,” compiled by the U.S. Coast Guard Historian's Office.

Available at <http://www.uscg.mil/hq/g%2Dcp/history/cutteraccidents.html>.

U.S. COAST GUARD CUTTER FIR

HAER No. WA-167

(Page 19)

National Park Service Inventory of Historic Light Stations. Available at

⁶⁰ Correspondence to Commandant (G-CCS) from Commander, Thirteenth Coast Guard District, dated September 30, 1991.

⁶¹ Wilcox, “FIR's Last Trip,” 4. MARIPOSA replaced FIR in her duties on Puget Sound.

<http://www.cr.nps.gov/maritime/lsum.htm>.

Noble, Dennis. "The Coast Guard in the Pacific Northwest." Available at http://www.uscg.mil/hq/g-cp/history/h_PacNW.html.

Peterson, Douglas. *United States Lighthouse Service Tenders 1840-1939*. Annapolis, MD: Eastwind Publishing, 2000.

Shanks, Ralph. "U.S. Coast Guard Cutter *Fir* (WLM 212) National Historic Landmark Study," 1991. Available at <http://www.cr.nps.gov/maritime/nhl.fir.html>.

Treasury Department, U.S. Coast Guard. *The United States Coast Guard: General Information*. Washington, DC: 1941.

"Trials of New Lighthouse Tender 'Fir' held at Oakland, Calif.," *Coast Guard Bulletin* 1, no. 2 (August 1939).

U.S. Coast Guard Division of Engineering. "Construction and Repair Topics," *The Engineer's Digest* (September 1930).

"USCG FIR (WLM 212)," decommissioning booklet, 1991.

"USCG FIR (WLM 212) REPAIRS," report. Located in vessel file.

Wilcox, Mark. "FIR's Last Trip," *Aids to Navigation Bulletin* (Winter 1997/1998). Available at www.uscg.mil/tcyorktown/atonblt/winter98/minor.htm.
<http://www.uscg.mil/hqlrtc/atonblt/winter98/minor.htm>.

The National Archives in Seattle, Washington, and the National Archives in Washington, D.C., provided correspondence, memos, photographs, and progress reports.

Section 3

PHOTOGRAPHY

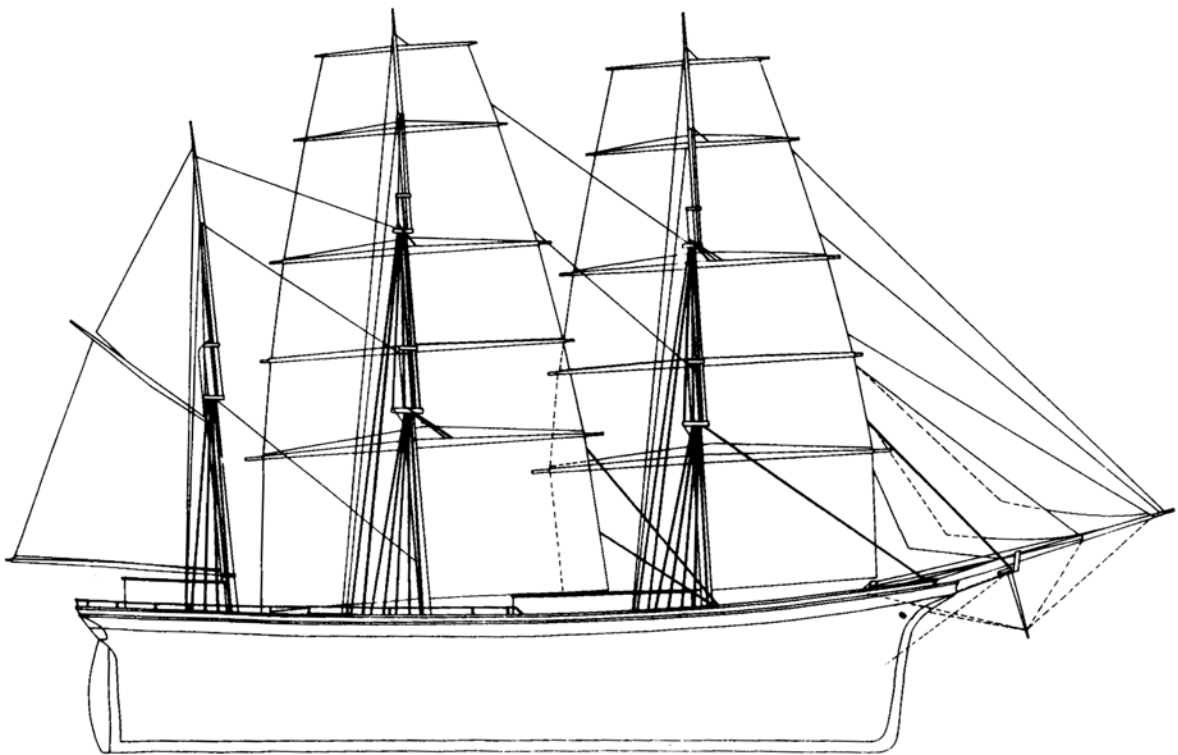

STANDARDS and GUIDELINES

Introduction: The outline format on the following pages provides a quick overview of general applications of the *Secretary's Standards* to the production of HAER large format photographs. The text that follows in Sections 3.2-3.3 tells you in more detail how to produce photos that meet the *Secretary's Standards*.

There are four parts to the outline, corresponding to each of the four standards *as they apply to large format photography*:

- I. Guidelines for explicating and illustrating what is significant or valuable about a historic vessel via photography.
- II. Guidelines for preparing photographs accurately from reliable sources.
- III. Guidelines for materials on which photographs are to be made.
- IV. Guidelines for producing clear and concise photographs.

The standards, as they apply to large format photography, follow well-established professional photographic practices. The distinguishing characteristic of HAER photography is that it is primarily a medium for capturing and storing facts and evidence about a resource, rather than a medium for artistic expression.

I. Explicating and illustrating what is significant or valuable about a vessel:

Required

Not Allowed

Take photographs of historically significant features, as determined by adequate research into relevant historical documents, publications, photographs, drawings and other sources.

Determine what significant features are best explicated and illustrated by photography, as opposed to measured drawings or written documentation alone.

Determine what views are best suited to explicating and illustrating the significant and valuable aspects of a vessel.

II. Guidelines for preparing photographs accurately from reliable sources.

Required

Not Allowed

Compose photographs from stations that offer the maximum coverage of historically significant features.

Adjust large-format camera lens and film planes so that vertical features are parallel in the photograph to within 1 degree, eliminating distortions from “keystoning”.

Include a scale stick in overall views to provide a scale reference for judging dimensions of objects in the photograph.

Select film and exposure settings appropriate to the vessel being recorded.

Caption resources and views accurately. Prepare and Index to Photographs.

Not providing a photo caption page or Index to Photographs.

Photocopy pre-existing materials such as historic photos, drawings, and illustrations that add to the record. Caption and credit authors.

Obtain copyright release for pre-existing images photocopied for HAER.

Photocopying a pre-existing image without written permission through a copyright release form.

3.1.4 Photography Guidelines

III. Guidelines for materials on which large format negatives and prints are to be prepared.

Required

Use black and white films and papers with stable base materials and emulsions; placing prints on fiber-based print papers for longevity.

Use color transparency (CT) films for a selection of color views. Make a duplicate CT and color laser “contact” copy – 8-1/2x11

Use negative sizes 4”x5”, 5”x7”, or 8”x10” and associated contact prints

Process negatives and prints in fresh or properly replenished chemistry, for proper temperature and processing times, including use of a hypo-eliminator bath or equivalent running water wash time.

Not Allowed

Use of film packs.

IV. Guidelines for producing clear and concise photographs.

Required

Shoot photographs with significant features in razor-sharp focus

Shoot photographs with lighting and exposures set so that significant features and details are registered on the negatives and easily visible in contact prints.

Organize a set of photographs into a logical progression of views: general context of vessel, principal elevations, significant exterior details and features, principal interior spaces, machinery, processes, etc.

Prepare an Index to Photographs with proper vessel name, location and HAER number; assign unique image numbers containing project HAER number to each negative and corresponding print; describe contents of each view in direct language, pointing out historic features or other significant information not readily presentable or discernable in a photograph without accompanying verbal data. (For example, names of spaces, parts, functions, materials, relationships)

Not Allowed

Use of soft focus lenses.

Not preparing an Index to Photographs

LARGE FORMAT PHOTOGRAPHY for HISTORIC SHIPS

Introduction. Large-Format Photography of surviving, historically significant vessels is employed by the Historic American Engineering Record to document and interpret such ships for future study, and occasionally for preservation. Photographs made for HAER are in the public domain and cannot be copyrighted.

Large format photography is defined in Section III of the *Secretary of the Interior's Standards for Architectural and Engineering Documentation* as photographs having negatives 4"x5" or larger (see Section 4.9 for the complete text of these standards). Popular smaller formats such as 2-1/4" x 2-1/4" or 35mm are not acceptable for documentation submitted to HAER, whether archivally processed or not. Negatives smaller than 4" x 5" should not be said to "meet HAER standards" even if retained at another repository. There are three reasons for these specifications: resolution, perspective correction, and handling. The ability of large formats to record and resolve detail is considerably superior to formats such as 35mm. This is primarily a matter of unalterable optical laws, and only secondarily one of equipment or film. Film for film, an 8"x 10" or 11" x 17" enlargement from a good 5" x 7" negative is many times sharper than one made from a 35mm negative, and is thus of much greater potential use to historians, restorationists, exhibit designers, etc. Though perspective correction (or PC) lenses are manufactured for small format equipment, large format view cameras are still more versatile in controlling composition and correcting distortions. Large format negatives are also more easily stored and reproduced at the Library of Congress, where negatives must be individually cataloged and filed. Smaller formats can be filed as field records, but do not fulfill the

photography requirements according to the Secretary's standards.

Photography is required for Levels I, II, and III of HAER documentation as defined in the *Secretary's Standards*. The following specifications include information about equipment, films, processing, subjects and composition, photograph identification, and submission of your work to HAER. There are also instructions for use by HAER teams for completing an Index to Photographs and for numbering prints and negatives with HAER numbers for transmittal to the Library of Congress.

Ships documented by HAER are professionally photographed as they exist today, and occasionally historic photographs and drawings are photocopied as well. HAER documentary photography is not intended to cover such things as progressive steps of current restoration work, since this is not within HAER's documentary purpose. Beyond general overall views, there is no cut-and-dried formula to follow when deciding how many photographs are needed to document a specific ship or just what needs to be covered in every instance. The focus and extent of HAER photography is governed by the significance of the particular vessel being recorded and of the features aboard her. Level I coverage--reserved for vessels of the highest significance--is much more thorough than Level III.

Where a predetermined list of photographs is not specified, photographers are expected to consult recording team historians, delineators, and review team consultants for guidance on subject matter so that coverage will not contain serious gaps. Documentation of a vessel is a team effort,

3.2.2 Photography for Historic Ships

hence photographers should feel free to discuss views and suggest changes when such things as lighting, coverage, or other factors can be improved. Formal photography aids in the preparation of measured drawings, historical reports, technical descriptions, and analyses in addition to providing a photographic survey of a ship. These records are intended to preserve the most significant information about a ship for 500 years, therefore, we urge you to meet the obligations of your responsibilities for photographic documentation.

Photographs to record historic ships *must* be produced according to the following criteria for acceptance to the HAER collection. Contract photographers are urged to read the following specifications before submitting an estimate or bid to HAER or to a third party performing documentation to HAER standards.

EQUIPMENT

Camera. The camera used must be a large-format view camera, no less than 4" x 5", no larger than 8" x 10", having all features necessary for perspective and focus correction, including bubble levels; *5"x7" is the preferred format.*

Note: These requirements will be waived only in cases of most extreme urgency (such as a vessel's imminent destruction) for which the timely procurement of large format photographers or equipment is not practical.

Lenses. No soft focus lenses should be used. The complement of lenses will include at least one of normal focal length, wide angle, and telephoto. View camera lenses must have adequate covering power to accommodate both front and rear camera movements without vignetting. Aerial camera lenses should not be less than normal focal length.

Filters. Photographer's choice. Use of a polar screen is encouraged when doing photocopy work.

FILM

Documentary photographs produced for HAER are mainly black and white. Occasionally, color transparencies are taken of selected views to record paint schemes or capture brightwork. Digital formats (electronically produced and stored images) are not acceptable due to their rapid technological obsolescence and consequent inaccessibility.

Continuous Tone Black and White Photos. Any fine grain cut (sheet) film may be used which has a minimum resolving power no less than 80 lines/mm high-contrast range and 32 lines/mm low-contrast range, such as Tri-X, Royal Pan, Panatomic-X, etc. ASA400 is recommended.
No film packs.

Color Transparencies (CTs). Since 1996, color transparencies are accepted into the formal collection. Consult with HAER prior to using.

Continuous Tone Photocopies. Kodak Professional Copy Film 4125 or equivalent must be used for making continuous tone copy photographs. This applies to copies of photographs and graphics with colors and/or grey tones. It may be used for line drawings, but is not preferred unless contrast is poor.

High-Contrast or Line Copies. Line copies must be made using Kodalith film or equivalent. This film should only be used to copy line drawings or other graphics where colors and grey tones are absent. 8" x 10" negatives are preferred. Opaquing and other forms of touch-up are not permitted since they themselves may not be archivally stable and may cause the negative to deteriorate.

PLEASE NOTE: Where preservation of scale and minimal distortion are important, a view camera should not be used to copy line drawings. Scale drawings should be submitted to a reprographics firm with a lithographic copy camera designed for such copy work.

PRINTS

Papers. All prints shall be glossy on single-weight, fiber-based paper in order to meet Standard III; “RC” (resin coated) paper or other bases will not be accepted.

Format. Contact prints. Multiple copies may be required. *See also “submitting photographs” on page 3.1.5.*

PROCESSING

Film and prints are intended to last 500 years. All film and prints shall be processed according to manufacturer’s specifications, using fresh chemistry. Each step in the developing process must be thoroughly completed with recommended agitation. (Developer should be replenished according to manufacturers’ specifications including limitations.)

Archival Processing. All film and prints must be thoroughly washed or treated in a hypo clearing bath (such as Permawash, Heico, Inc., Delaware Water Gap, Pennsylvania, or equivalent) in order to remove all traces of processing chemicals. This is essential to meeting Standard III. Film and prints must be washed before and after the hypo clearing treatment.

Tests. After processing, film and prints should be tested periodically for significant traces of residual hypo (sodium thiosulfate). Visible levels above comparison patch #1 of the standard Kodak Hypo Estimator Scale (Kodak publication J-11) used with test kit (Cat. No. 196-5847) is cause for rejection of film and/or prints. *Film and prints developed by automatic processors have repeatedly failed the above test and are not considered archivally permanent.* Tests are only accurate if performed within 24 hours of processing, so it is highly recommended that photographers test their film and prints before submitting them to HAER.

Stains and defects. Negatives and prints with visible hypo stains, poor focus, scratches or other defects will be rejected.

TECHNICAL INFORMATION

Composition. All photographs must be composed to give primary consideration to the architectural/structural features of the vessel with aesthetic consideration necessary but secondary. No features vital to the vessel shall be cropped out or hidden by vegetation, dockside machinery, or buildings unless this is absolutely unavoidable. Undesirable intrusions such as trash barrels, litter, bicycles, etc., shall be removed or concealed. Vehicles or other vessels, *when possible*, should be moved from view. Period furnishings, tools, and equipment should not be removed, but care should be taken that they do not block essential details of the vessel. Artistic judgment is necessary and must be exercised by the photographer. Portions of mechanical or structural elements, such as an anchor capstan or hanging knees, must not be cropped from the picture when they are the primary subject of the photograph.

Lighting. Sunlight is preferred for exteriors, however, light overcast days may provide more satisfactory lighting at times. Flash units or reflectors may be needed to cast light into shadowed areas. Interiors should be illuminated to reveal detail in shadow areas. Be sure to check holds, engine rooms, and machinery spaces for flammable fluids and vapors before using a flash.

Focus. All areas of the picture must be in razor-sharp focus to meet Standards II and IV, regardless of the level of documentation being conducted. The use of a magnifying device is strongly recommended for focusing the camera.

Perspective Distortion. Since ships do not offer readily plumb or level lines and surfaces as do buildings, it is harder to adjust the camera to minimize distortion. However, views should *appear* to be plumb and level, i.e., having one- or two-point perspective. There must be no

3.2.4 Photography for Historic Ships

obvious perspective distortion unless deliberately introduced in a very limited number of cases for reasons of aesthetic effect or coverage in cramped quarters. Some oblique views (three-point perspectives) may be unavoidable in some cases, or even necessary for proper coverage (some parts of rigging, for example).

Exposures. Negatives must be correctly exposed. Thin or dense negatives may be rejected.

Photocopies. See *FILM* above. Every effort should be made to make photocopies in a studio under controlled conditions using polarized light. The copying of scaled drawings where preservation of scale and proportion are important should only be made by a reprographics firm having a lithographic copy camera. *All HAER photographs must be in the public domain.* Photocopying of copyrighted material is prohibited unless written waivers to all rights are obtained from copyright owners and put on record at HAER. (see Fig. 3.2.1 for a sample of the **COPYRIGHT RELEASE FORM**)

VIEWS

General exterior and interior survey views required for Levels I, II, and III coverage are listed below; the checklists below are not exhaustive. Specific directions may be given as needed, usually on a Photographic Services Request form (see Fig. 3.2.1) if on-site direction is not available. Further views required for Level I or II coverage (including any materials to be photocopied) will be listed on the above form, especially where on-site consultation and direction on subject matter is not available. If a number of ships and/or documents are to be photographed, a list complete with their

locations and the names, addresses, and telephone numbers of owners and/or critical contacts will be provided on the Photographic Services Request form.

EXTERIOR

Outboard. (required for Levels I, II, and III coverage of intact vessels and hulks)

Profile (port or starboard)
3/4 view at bow
end-on view of bow
3/4 view at stern (port or starboard
quarter)
end-on view of stern

(If possible, obtain views while vessel is out of the water. Include views of rudder/propellers.)
wreckage, debris field (in cases of deterioration)

Weather Decks. (required for Levels I, II, and III coverage of intact vessels and hulks)

Main deck, showing general
arrangement of deckhouses,
rails, superstructure, equipment,
etc.
Forecastle head, poop deck, other
exterior deck areas

Details. (primarily for Level I coverage)

bowsprit
capstans, winches
bulwarks and rails
carvings, ornaments
hatches and covers
companionways
skylights
pumps
donkey engines
steering gear
binnacle
fife rails

masts, rigging

3.2.6 Photography for Historic Ships

RELEASE AND ASSIGNMENT

I, _____, am the owner, or am authorized to act on behalf of the owner, of the materials described below including but not limited to copyright therein, that the National Park Service has requested to use, reproduce and make available as public domain materials at the Library of Congress as part of the Historic American Buildings Survey/Historic American Engineering Record collections. (If not the sole copyright owner, please specify in the space below any additional permissions needed, if any, to grant these rights.) I hereby transfer and assign to the National Park Service any and all rights including but not limited to copyrights in the materials specified below.

Survey Number: HABS No. _____ or HAER No. _____

Types of Materials (please check all that apply):

Photographs _____ Illustrations _____ Textual materials _____ Oral History/Interviews _____
Audiotape _____ Videotape _____ Other (describe) _____

Detailed Description of Materials (attach additional pages if necessary):

Additional Permissions Needed, if any (for example, copyright owner, subjects in photographs, illustrations in text):

Disposition of Materials After Use (please check one): _____ Return to owner
_____ May be retained

Name (please print)

Signature

Date

Address

Telephone Number

Fig. 3.2.1
Sample COPYRIGHT RELEASE FORM

davits, derricks
boats
equipment peculiar to vessel's
trade or type

INTERIOR

Appropriate views selected from the checklist below are required as part of Level I, II, or III coverage, depending on the subject's significance.

accessible framing and structure of hull
structural details
machinery spaces (engine rooms, boiler
rooms, auxiliaries, tanks, shaft
alleys)
wheelhouse
navigation, communications equipment
captain's quarters
crew's quarters
passenger's quarters
public spaces (saloons, dining rooms,
staircases)
work spaces (holds, storage)
architectural details (joinery, carvings,
glass lighting fixtures,
metalwork, brightwork)

OPERATIONS

vessel under way
vessel performing typical duties (e.g.,
ore unloading, fishing,
dredging, towing barges, etc.)
work performed aboard vessel, showing
uses of significant features,
machinery, etc.

Scale Sticks. For Level I coverage, duplicate views of primary significant features (as opposed to overall views) must be taken with a scale in the field of view. A minimum of one

view with a scale stick is required for Level II or III coverage. For general views, the stick should be 8 or 10 feet in length and at least 1.5 inches wide, painted in alternate black and white areas of one foot each; the last 12 inches should be similarly divided into one-inch black and white stripes (see Fig. 4.5.3 on p. 4.5.6). There is no requirement or prohibition for additional use of a metric scale.

A stick whose section is flat or square is less likely to roll in the horizontal position than one which is round.

The stick should be positioned vertically or horizontally against the structure in a position easily visible and legible to the camera. A small 6" or 12" scale may be especially valuable in detail views where no easy reference for scale exists. In any case, the scale should not conceal or confuse the details being recorded by the camera, and should be clearly in focus.

Aerial Views. Aerial views may be requested to further record site conditions, especially in the cases of hulks or "graveyards." These may include both oblique and plan (direct overhead) views.

Aerial views may be made from atop adjacent tall ships, buildings or land masses. If these are not accessible a helicopter would be needed. Recommended flying altitude ranges from a low of 150 feet to a maximum of 500 feet. HAER suggests that the photographer require the door to be removed from the aircraft and that he/she is positioned with appropriate restraints at the opening. Minimum format for aerial photographs is 4" x 5". Standard aerial film, *archivally processed*, is acceptable. Views should be black and white. A yellow or orange (G) filter should be used to reduce haze effect.

3.2.8 Photography for Historic Ships

SUBMITTING PHOTOGRAPHS

(see also “Preparations for Transmittal to the Library of Congress” p. 3.3.1)

Index to Photographs. The photographer *must* provide full written identification of each photograph taken and submitted. *Do not put identifications on the backs of prints.* (Use of a drawing, such as a deck plan, to further pinpoint location and direction of view may be helpful; drawing and verbal identification must be cross-referenced by match numbers.) Written identification must include, in the following order:

1. **Vessel name** (including rig/propulsion, e.g., Schooner EXAMPLE; vessel’s name should be all in capital letters)
2. **Location** (river/harbor, pier/street, city, county, state)
3. **Photographer’s Name**
4. **Photographer’s Firm** (if any)
5. **Day, Month, and Year** of view
6. **Brief Description** of views, including orientation of camera to vessel (e.g. looking forward, looking toward port quarter, etc.); compass orientation should be included for hulks.

Data such as shutter speeds and f-stops are not required.

The photographer should not prepare an Index to Photographs (HAER format) unless specifically told to do so. Photos must be reviewed by the recording team, review team, (and HAER staff) and put in order, inferior views culled, and historic views and photocopies included in a logical sequence. Captions must be prepared and reviewed by historians before the Index can be prepared. (Proper photo

identification provided by the photographer is essential to this process.)

Required Submissions. One original black and white negative and one good quality contact print of each photograph (unless more are specified) will be submitted. All contact prints shall be glossy finish on single-weight, fiber-based photographic paper. Contact prints must be made with black (bleed) margins of the entire sheet of film to reveal all details in the picture area plus the clear film margin (no washed-white margins). *Do not write on the margins of film or prints (numbers, dates, etc.).* Most inks are acidic and non-archival. They do not meet Standard III will adversely affect the life of photographic materials. Again, *do not write identifications on the backs of prints.* Each negative should be placed in a transparent sleeve, and each sleeved negative, with contact print(s), should be placed in an archival paper filing envelope for film storage. Number all negatives on the transparent sleeves only (crayon, marker) and put match numbers *in No. 1 pencil* on the *back edge* of each contact print and on the storage envelopes. Write the complete identification for views on the **INDEX TO PHOTOGRAPHS** (as directed under **Identification**) using the match numbers of the negatives.

Exclusive Use. All photographs and photocopies submitted to HAER become public domain property. Photographers may make duplicate original or copy negatives and prints for the use of others or themselves, provided that a credit line (e.g., John Doe, Historic American Engineering Record [or HAER]) is used.

PREPARATION OF PHOTOGRAPHS FOR TRANSMITTAL TO THE LIBRARY OF CONGRESS

Introduction. The instructions below are intended for HAER teams who are expected to submit completed photographic documentation at the close of their projects. These instructions may also apply under certain circumstances to agencies, contract photographers, or donors submitting documentation to HAER.

Organization. After the photographic coverage of a vessel has been processed and reviewed, all photographs--whether modern images, photocopied historic views, or line drawings--should be selected and put in a logical progression prior to numbering and captioning. Progressions might be chronological (by date), exterior to interior, or even category of image (line drawings might be grouped together, for example). In general, aerial and exterior views should come first, followed by interiors, and then details.

The “HAER Number”. The HAER number for your vessel is the primary identifier for all negatives, prints, captions and other materials from a project. It consists of a two-letter state code abbreviation (same as that used by the U.S. Postal Service), followed by a hyphen and a project number: CA-54, for example, is the number assigned to HAER records of the ship *Balclutha* located in San Francisco, California. The project number should *always* be preceded by “HAER No.” in order to distinguish it from a HABS project with the same number. These numbers are assigned only by HAER in order to avoid accidental duplication and consequent confusion with records of another site. Corresponding negatives, prints and captions are identified in succession by adding a suffix to the HAER number: HAER No. CA-54-1, HAER No. CA-54-2, etc.

*CHECK FOR EXISTING HAER PHOTOS

If photographs are already on file in the HAER collection, then any new images are considered addendums to the record. Addenda photos are numbered consecutively from the last view of the previous images. Example: images XX-2-24 already exist – new images start with XX-2-25

Negatives. Negatives should be labeled *only on the glossy side, only on one of the clear margins (preferably on the upper right corner)*, never in the image area (see Fig. 3.2.1). Only a carbon particle based drafting ink rated for plastics (such as “Pelikan FT” or equivalent) is to be used. The only exception to this placement of the HAER number is in cases of lithographic negatives (“line” or “litho negs”) of historical drawings. Such negatives frequently have no margins, so a portion of the darkened emulsion outside the image area should be erased and the HAER number inked on the glossy side over this cleared area.

Negative Sleeves. Negative sleeves for transmittal to the Library of Congress are made of archivally stable buffered paper, and come in two sizes, 5”x7” or 8”x10”. If your project is not supplied with these, leave labeled negatives in their temporary plastic sleeves for transmittal to HAER--the HAER office will transfer them to archival sleeves. Clear plastic sleeves need no labeling, *but they must be removed if you put negatives into archival sleeves*. Paper sleeves should be labeled only with the HAER photo number (e.g. CA-54-1) in No. 1 pencil (no ballpoint ink, no drafting ink), or else typed (impact printed, not laser printed). Small (5”x7”) sleeves should be labeled to the right with the opening at the top, large (8”x10”) sleeves in the upper right corners with the sleeve opening at the right side (see Fig. 3.3.1) *Sleeves should*

never be labeled with the negatives inside, since creasing will result!

Contact Prints. Contact prints should be labeled with corresponding HAER numbers *on the back side, on one edge only (preferably upper righthand side)*, using only No. 1 pencil (no ballpoint ink, no drafting ink).

Stamping and Mounting of Contact Prints. In most cases, this will be done by the National Park Service. If the task is yours, however, the backs of all prints should be stamped by a rubber stamp and archival manuscript ink with a rubber stamp identifying the image as part of the HAER collection in the Library of Congress. (Do *not* fill in the blanks in the rubber stamp impression.) When the stamped information is dry, prints are mounted in archivally stable 82"x11" cards with slits cut in to receive print corners (glue is prohibited). The HAER number is lettered with No. 1 pencil or impact printed (typed) in the upper right corner of the cards, underneath the preprinted heading. (Laser printed numbers are not archivally stable.)

Index to Photographs. This is the caption listing for all of a project's photographic images, including photocopies. The standard format for the first page of the Index appears in Fig. 3.3.2. Successive pages need only a heading in the upper right corner in the standard format shown below:

Name of Vessel
INDEX TO PHOTOGRAPHS
HAER No. XX-1 (Page X)

Captions. Captions should be descriptive, giving orientation aboard the vessel, names of significant spaces, details, machinery or parts. Comments on the significance of photographed features is encouraged, as are cross-references to other photographs and photocopies, measured drawings, or the historical report. Please identify any intrusions as such.

Photocopies and Historic Images. Photocopied photographs and other graphics should always be identified as such in captions. Pertinent information such as the *original* photographer's name, date, subject, location, size of original photograph, sources, etc. should be provided. For drawings, information such as sheet title, delineator's or designer's name, date, sheet number, location of original, etc. should be provided. The photocopying photographer's name is unnecessary.

Multiple Photographers and/or Sources. Some projects will have a photographic record drawn from the work of a modern photographer, photocopies of photographs by two or more previous photographers, and photocopies of drawings or other graphics. In such cases, wasteful repetition can be alleviated by identifying all photographers and sources on the first page of the Index to Photographs and then assigning them initials to be used in appropriate photo captions (see Fig. 3.3.3).

Color Transparencies (CTs). Some projects will include color transparencies. Duplicate CTs should be made from the original CT and each is numbered and placed in a separate numbered archival sleeve, one stamped "original" the other stamped "duplicate". The number is marked sequentially from the last black and white image and "CT" is added after the number. A color laser copy on 8.5"x11" archival bond is made from the duplicate CT and is trimmed to fit in a transparent sleeve with a photo mount card noted with the proper index number unobstructed at the upper right. (see Fig. 3.3.2)

HISTORIC AMERICAN ENGINEERING RECORD

INDEX TO PHOTOGRAPHS

Name of Vessel (e.g., Schooner EXAMPLE) HAER No. EX-1
(Secondary Name in parenthesis)
Location (river, harbor, institution, etc.)
Street Address (or best approximation)
City
County [abbreviations such as "St." (Street), "Co." (County),
State or "CA" (California) are not permitted]

All photographs by [name of photographer], [month], [year].

EX-1-1: [Caption] [on the caption sheet, the words "HAER No."
may be omitted from each photo number listed,
but each negative, negative sleeve, print,
and photo mount card MUST have the format
"HAER No. XX-00-1"]

EX-1-2: [Caption]

EX-1-3: etc.

INDEX TO COLOR TRANSPARENCIES

EX-1-4-CT [Caption]

EX-1-5-CT [Caption]

Fig. 3.3.2

3.3.4 Transmittal of Photographs

HISTORIC AMERICAN ENGINEERING RECORD

INDEX TO PHOTOGRAPHS

Schooner EXAMPLE HAER No. EX-1
American Maritime Museum
No. 20 Fishermans' Harbor
Lake City
Somename County
Somestate

Credit JJD: Photographs taken of Schooner EXAMPLE in New York Harbor, July 15, 1921 by John J. Doe. Original photos in possession of Mrs. John J. Doe of Hackensack, New Jersey.

Credit STJ: Photographs taken of Schooner EXAMPLE on marine railway at Smith's Shipyard, 123 Front Street, Philadelphia, Pennsylvania, by S.T. Jones, April 1930. Original photos in possession S.T. Jones of Philadelphia.

Credit AMS: Photocopies of drawings dated August 4, 1953; prepared by A.M. Smith, Naval Architect of Flotsam & Jetsam, Inc., Philadelphia, Pennsylvania, for installation of engines and staterooms in Schooner EXAMPLE. Drawings in files of Smith's Yacht Repair (successor to Smith's Shipyard), Philadelphia.

- EX-1-1 Credit JJD: Starboard profile of EXAMPLE at anchor. Exact location undetermined; Statue of Liberty in distant background.
 ...
- EX-1-9 Credit STJ: Rebuilding of port bow and rail at Smith's Shipyard, Philadelphia, Pennsylvania, after collision with barge on April 1, 1930. New anchor winch (Smith & Jones, Philadelphia, Pennsylvania, No. 3) in crate to right of photo. This winch still in place during 1987 recording project.
 ...
- EX-1-22 Credit AMS: Photocopy of "EXAMPLE, Sheet No. 2" (original drawing 21" x 35", 3/8" scale) showing 'tween deck plan.

Fig. 3.3.3

Section 4
DRAWINGS

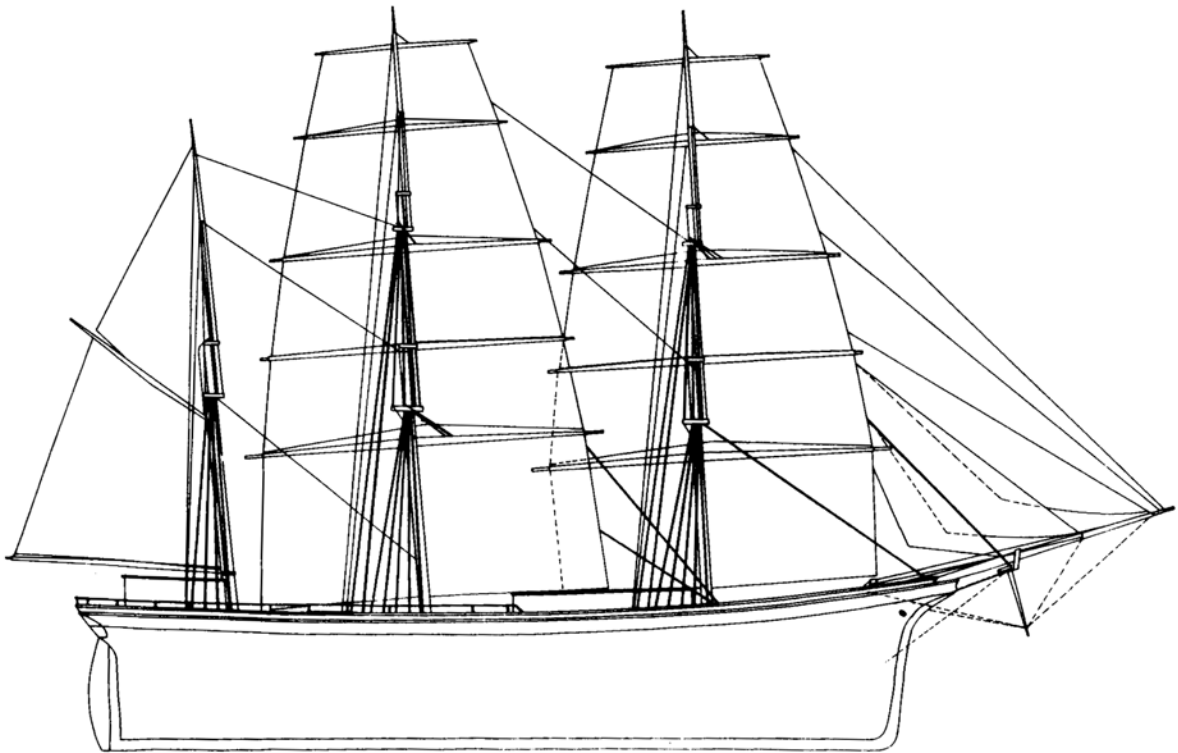

STANDARDS and GUIDELINES

Introduction. The outline format on the following pages provides a quick overview of general applications of the *Secretary's Standards* to the production of HAER measured drawings. The text that follows in Sections 4.2-4.6 tells you in more detail how to accomplish work that meets the *Secretary's Standards*.

There are four parts to the outline, corresponding to each of the four standards *as they apply to measured drawings*:

- I. Guidelines for explicating and illustrating what is significant or valuable about a historic vessel.
- II. Guidelines for preparing drawings accurately from reliable sources.
- III. Guidelines for materials on which drawings are to be made.
- IV. Guidelines for producing clear and concise drawings.

The standards, as they apply to drawings, follow well-established intellectual and ethical rules for good research and presentation. However, there are limitations imposed by the nature of archival records, the need for their longevity, accessibility, and their reproduction that must be addressed. Many commonly accepted architectural drafting "styles" or drawing "tastes" do *not* meet the *Secretary's Standards*, so please read these sections carefully.

I. Explicating and illustrating what is significant or valuable about a vessel:

Required

Determine what aspects of the vessel are historically significant, based on adequate research into relevant historical documents, publications, photographs, drawings and other sources.

Determine what significant features are best explicated and illustrated by measured drawings, as opposed to photography or written documentation alone.

Determine what sorts of graphic views (e.g. maps, plans, elevations, sections, topographic maps, isometrics, perspectives, exploded views) or combinations of them are best suited to explicating and illustrating the significant and valuable factors.

Determine if any pre-existing drawings clearly explicate and illustrate significant factors; photocopying such drawings, or using them as bases for new drawings.

Use verbal annotations in drawings to label significant conditions, features and parts, or to describe process, or explicate the impact of historic events, such as modifications, additions, damage by fire, etc.

Not Allowed

4.1.4 Measured Drawing Guidelines

II. Guidelines for preparing drawings accurately from reliable sources.

Required

Prepare measured drawings from clear, thorough field notes, in which are recorded representative sketches and accurate measurements actually taken from the vessel being documented.

Prepare measured drawings from thorough dimensions obtained from a correctly operated photographic or digital measuring system.

Select field measurement methods and equipment appropriate to the resource being recorded, and using the methods and instruments within their capabilities and limitations.

State in field notes and measured drawings the field methods and instruments used, and the accuracy of their results.

Measure the resource within a reference frame aligned with the principal planes of the vessel (if it is floating or hauled) or using an independent reference frame if the vessel is a hulk or wreck.

State in field notes and measured drawings any parts of a vessel that were inaccessible for sketching, measurement or photography.

Depict actual existing conditions of the vessel, or depicting pre-existing conditions based on adequate historical documentary or on-site evidence.

Check any pre-existing architectural or engineering drawings against the vessel itself for discrepancies in dimensions, features, conditions, etc.

Properly cite verbally in measured drawings any drawings, photographs, or other sources used in addition to or in place of actual measurements of the vessel.

State in field notes and measured drawings the names of vessel, deck levels, materials, profiles, lines, and machinery parts, etc.

Make numerous field photographs for use as general survey, checks for context, checks for field notes at the drawing board, for use by future users and researchers.

Include graphic scales and written significant dimensions on measured drawings to indicate actual dimensions of recorded resource.

Not Allowed

Failing to provide documented hard-copy printouts of instrument-gathered field data and including them with field records for final project transmittal

Damaging or destroying without permission any significant or valuable historic fabric or finishes in attempts to obtain measurements.

III. Guidelines for materials on which measured drawings are to be prepared.

Required

Prepare drawings in waterproof, permanent (fadeproof) black ink (or equivalent) which is properly formulated to adhere permanently to the base material, and does not cause the base material of the drawing to deteriorate.

Prepare drawings on durable (tear resistant, acid-free) translucent, inert base materials (such as polyester drafting films or buffered vellums) with a projected 500 year life span.

Use either 19"x24", 24"x36", or 33"x44" drawing sheets with preprinted HAER borders. DXF file templates available with HAER borders, title blocks, layers, and line weights for drawings created using CAD software.

Plot drawings on drafting film with pen plotter using archival inks or laser printing technologies.

Prepare photographically reproduced copies of historic drawings on durable materials and processing them archivally for a 500 year life span.

Use 17"x22" sheets of 8x8 gridded bond paper for field notes

Not Allowed

Preparing final drawings in pencil, which smudges easily, and does not reproduce clearly.

Preparing final drawings in any medium that smudges in ordinary handling, or does not reproduce clearly

Preparing drawing in colored inks or other media, since they may not be archivally stable, or readily reproducible with proper color fidelity.

Plotting drawings with inkjet printers.

Using adhesive drafting media such as dry transfer lettering or rendering materials, since their adhesives have short life spans.

Collecting and submitting original architectural and engineering drawings for submission to the HAER collection at the Library of Congress.

4.1.6 Measured Drawing Guidelines

IV. Guidelines for producing clear and concise drawings.

Required

Organize a drawing set into a progression of similar views: lines plans, deck plans, profiles, sections, details, exploded views, process diagrams and schematics.

Lay out drawings with distinguishable zones for linework, scales, labels, and verbal annotations.

Use proper line widths to emphasize major components of the vessel and delineate fine details.

Use appropriate rendering symbols and techniques to indicate and distinguish different materials in the vessel in plan, profile, and section

Use drawing scales appropriate to the size and significance of vessel being recorded.

Use lettering sizes and styles that are easily legible in the full size drawing or in reduction to 25% of full size.

Use lettering sizes, styles/typefaces, and weights appropriate to the functions of verbal material in a drawing.

Use verbal annotations to provide information not readily presentable or discernable in a drawing, e.g. names of spaces, parts; historical data important to interpreting a drawing; significant field or documentary data affecting a drawing's content or accuracy; labels for match lines, base lines, datum lines, etc.

Use number keys (or tags) with arrows to annotate features which are too close together or in spaces too confined by significant linework to annotate directly with labels.

Cite and explain anything in drawings which differs from as-is conditions.

Include graphic scales and written significant dimensions on measured drawings to indicate actual dimensions of recorded vessel.

Not Allowed

Using only a single line width or such a narrow range of line widths that confusing figure-ground effects result.

Using non-industry standard material symbols without explanatory labels.

Using excessively stylized lettering/typefaces that are difficult to read.

Using lettering where upper case letter height or lower case body height is smaller than 3/32" on 19"x24" drawings, smaller than 1/8" on 24"x36" drawings, or smaller than 5/32" on 33"x44" drawings.

Using a single lettering size and/or weight for all lettering on a drawing sheet.

Omitting arrows, or placing labels and number keys in positions where their indications are ambiguous.

Failing to cite sources for drawings based on anything other than field measurements, whether these sources are other drawings, historic photographs, written or oral accounts.

LEVEL I DOCUMENTATION: WHAT'S INVOLVED IN THE DRAWINGS OF YOUR SHIP?

First of all, you must acknowledge that a “voyage” of this type only comes to a successful conclusion through genuine *teamwork*. Crewmembers not working together, combining their strengths and contributing from their diverse backgrounds and interests, can end up beached. You cannot work alone, not only because the vessel's size requires additional hands for the field work, but also because thorough Level I documentation must draw upon several disciplines. Some team members may be researching the vessel's past, others may be studying her fabric, making large-format photographs, or performing other tasks necessary to document her properly. (Do not overlook or fail to build on any previous documentary work on your vessel.) Each discipline's contribution to the effort is essential to the others' success, and to the quality of the documentation as a whole. The field records and final drawings you produce will complement the written and photographic records, presenting facts about the vessel that monographs or photos cannot do as effectively. You will need the team historian's input to decipher some of the peculiarities you come across in your field work, or you may need to find the shipwright on your review team whose trained eye can fill in the gaping holes in the hull. An old, faded photo may point to the type of engine or wheelhouse instruments she once had. And you will find your work as a team eased by covering some parts of the ship photographically. By the same token, the paint outlines you notice, or changes in the ship's structure, will be clues for historians to consider, confirming or challenging what they may distill from their research.

The need for cooperation and a lively exchange of knowledge, observations, and ideas will become clear when you first board the vessel and begin work. You will find yourself confronted with a number of

“dimensions”--clues to her work, care, design, and construction philosophy, and many other things. Some of these will be easy to spot. Others lie hidden, and require the combined detective work of the team and a qualified review team of ship specialists. Ask questions. Be adventurous. Don't be discouraged if you don't “get it all” the first time out--nobody does. If you are not familiar with ships, there will be some new jargon to learn. If the sight of all those compound curves and oddly angled parts is intimidating, there are many tried-and-true methods for recording and delineating them. You are taking part in a process with a long history of tradition and practice, much of which HAER has tried to condense for your use in these guidelines.

The ship around you, aside from her hull, compartments, means of propulsion, and innumerable pieces of nautical hardware, is for our purposes akin to a mammoth museum artifact. Everything about her is a product of somebody's decision at some time or other. She is a silent record of her designer's tradition and ability, shipwrights' skills, her owner's business decisions, her crew's living standards, maintenance habits, and ways of earning a living. Her present condition may even be a sign of an era, or of changes in an industry, regional economy, labor relations, or developments in technology. You and your fellow crew members will learn to “read” these things by picking up on the scores of clues aboard, but your skills will only develop as you depend on each other's form of research and share your knowledge of the ship's history, structure, materials, service, and the people who owned, designed, built, and sailed her.

Since you are responsible for lifting and drawing the vessel's lines and making construction drawings, of all your coworkers you may have the most intimate knowledge of your vessel's

structure, materials, and dimensions. Do the dimensions tell a story only you would be the first to know? Do irregularities mean anything?--construction efficiency? age and use? cheap, sloppy repair jobs? What signs of modification or repair are there? Where are things crafted with precision or given a high finish? Why? What may this unusual piece of joinery mean, or that patch in the deck? How about the wear in the rail at the bow, or the rusty holes in the deck beams? What you find in the bilges can even be clues to the vessel's service or her crew's attitude to their work. Keep in mind that it is important not to shrink from the unknowns--they too may hold interesting surprises, or even critical considerations. You will find yourself going over the ship with combs of finer and finer teeth as you gain new insights during field work and as your drawings take shape at the drafting board. Some of your observations may eventually take the form of notes or even separate, specialized drawings. As always, the team should consult its review team on questions, methods, and conclusions.

As more and more information comes together about your vessel, the new kinds of twists and questions to pursue can grow to seem endless. No team or its HAER records could hope to cover all the relevant threads of thought. The limitations of time, funds, available records, and access to parts of the ship will eventually make themselves felt as your project proceeds, and the team will have to decide which courses to pursue, and which to cut short. The team will also have to decide what aspects are to be written, or photographed, or drawn. In order to make such judgments soundly, it is imperative that all team members share whatever technical and historical information they acquire and that they actively seek the advice of the project's review team on important questions and problems. A thorough understanding of your vessel is essential to these decisions. The HAER office and staff are available to help as much as possible, but the job of pinpointing and treating significant features may eventually fall to the team itself.

You may also have to take into account the agendas of vessel owners or project cosponsors in your work. In general, any such additional agendas will have been agreed upon between HAER and the other parties before your project begins. HAER documentation is public material (it cannot be copyrighted), and hence may see all sorts of uses: educational materials, model-building, museum exhibits, poster graphics, scholarly studies, vessel repair, restoration, or replication (particularly in conjunction with detailed field records)--the list is long and varied. While HAER drawings should be accurately scaled and thoroughly annotated, they are not intended to be "working" or "shop drawings" complete enough for building full-size vessel replicas or reconstructions. Documentary drawings show a user "what was there" in accurate scaled views and notes, but except for the simplest of small vessels, they will not contain all the dimensional and structural information needed by shipbuilders, machinists, foundries, pipefitters, and other trades to proceed directly to work. Supplementary material and numerous detailed drawings will be essential in such cases, especially for large steel vessels with complex mechanical systems. Properly executed HAER drawings can provide excellent baseline information for such work. A full set of shop drawings sufficient for building a replica of a large steamer might result in several hundred sheets covering structural details, all parts of propulsion equipment, piping, electrical, etc. HAER drawings and field notes form an information base from which such drawings can be generated for construction purposes, but production and curation of shop drawings themselves is beyond HAER's mission. Existing shop drawings of vessels can be extremely valuable to a recording project (as well as for restoration or replication), since they can provide significant historical and technological information as well as dimensions. HAER data should note the existence and location of any such drawings, and those used in production of HAER drawings should be noted thereon. The

HAER team or its review team should recommend repositories for shop drawings, old photographs, or other historical records whose survival is threatened. Selected items may be photocopied for HAER, but HAER cannot accept the original items themselves.

As the team refines its documentation and drawings, you should get used to playing the role of someone looking at your work several hundred years from now. The old adage “familiarity breeds contempt” bears repeating: familiarity may unnecessarily limit your thoroughness and the usefulness of your work. How clear are your field notes and how well did you explain the parameters of your work? Did you note any specialized terms or technologies that may otherwise be swept into relative obscurity? Did you leave any unintentional or unexplained ambiguities? Did you drop important questions or details because you couldn't answer them? Why not discuss these things? Cultivating such a viewpoint is important, because large vessels, as artifacts, are often doomed by their size. Unlike smaller boats or other more portable artifacts which find their way more easily into museums, the preservation of a large vessel for future generations is a complicated and very expensive undertaking. Few that will be recorded for HAER will receive any further preservation efforts than that which you are giving them--preservation “on paper.” It is vital, therefore, that you consider the probable perspectives of someone looking at your work without the benefit of contexts that have become second nature to you. They will not have the opportunity to go back to the vessel itself for further work.

In many ways, the records you will produce have significant advantages over the real vessel. Their accessibility, reproducibility, portability, and care present far fewer problems and expenses than outright preservation of the vessel itself, especially over the 500-year lifespan accorded to HAER materials. Drawings,

particularly lines, plans, sectional views or “exploded” assemblies, present information in ways no one would ever see in photographs or real life. However, all drawings--whether based completely on measurements or to some extent on accumulations of other evidence—are necessarily *selective* about what facts are presented. To this extent, they all are *interpretive*, and will always be more limited than the vessel itself in terms of information content. Therefore, you need to be as well informed as possible in order to capture the most important things worth preserving, and present them as clearly as you can.

The following chapters of Section 4 cover field methods and drawing presentation in much greater detail, along with refined points of HAER's documentary philosophy and examples of previous work. You should become particularly familiar with these sections, but do not neglect the historians' and photographers' guidelines, since the success of your efforts depends to a considerable extent on your understanding of your teammates' roles in this recording project.

Glossaries. A brief glossary of general nautical terms used in this section is included in the following illustrations for easy reference in using these guidelines and in getting around the vessel you are recording. Be prepared to encounter local variations, and be sure to keep a more extensive glossary handy for further details. Local terms *must* be shown on final drawings, and where they vary from more generally used terms, the general terms must also be given in parentheses. A European glossary may be needed for European-built vessels. Several titles are listed in Section 4.8, References and Resources.

Anchors aweigh!

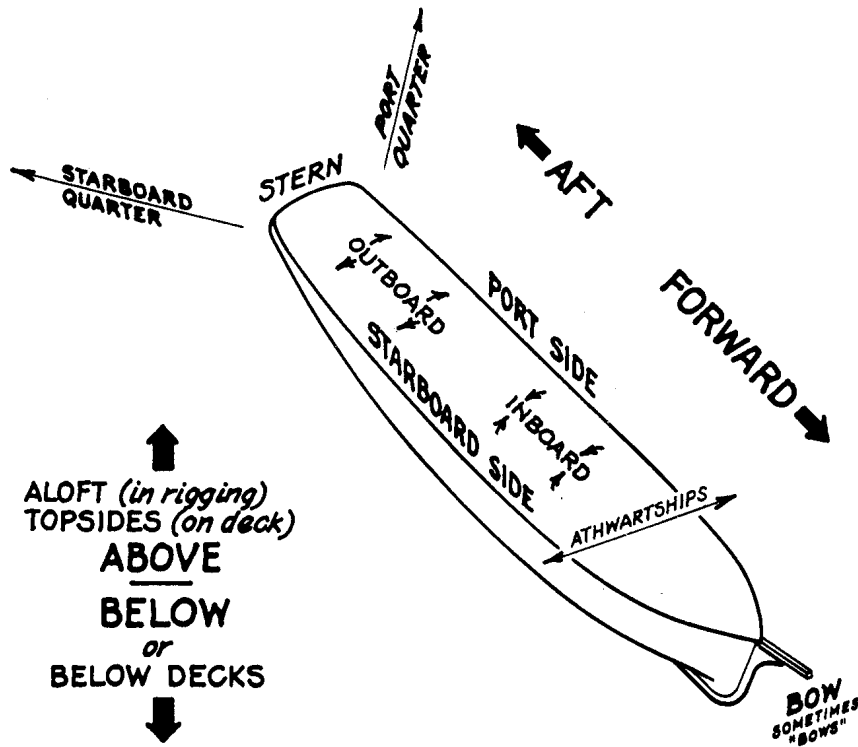

Fig. 4.2.1
Directional Orientation Aboard Ship

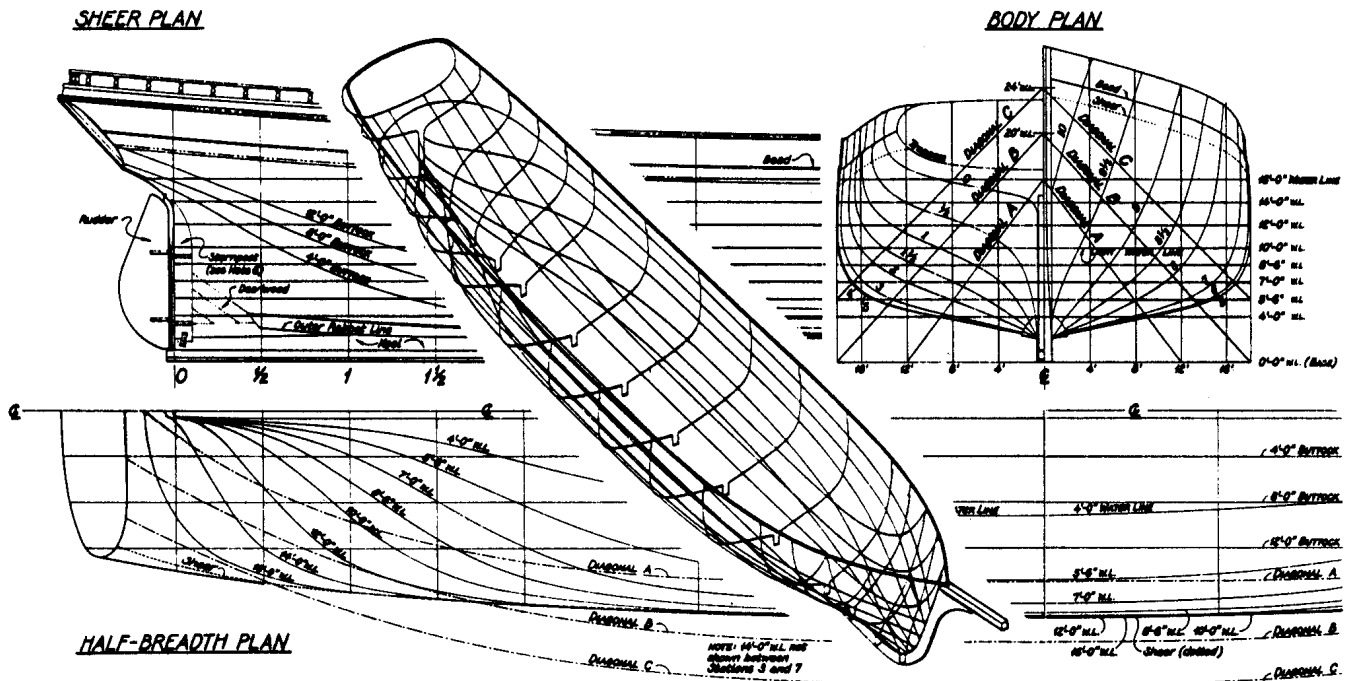
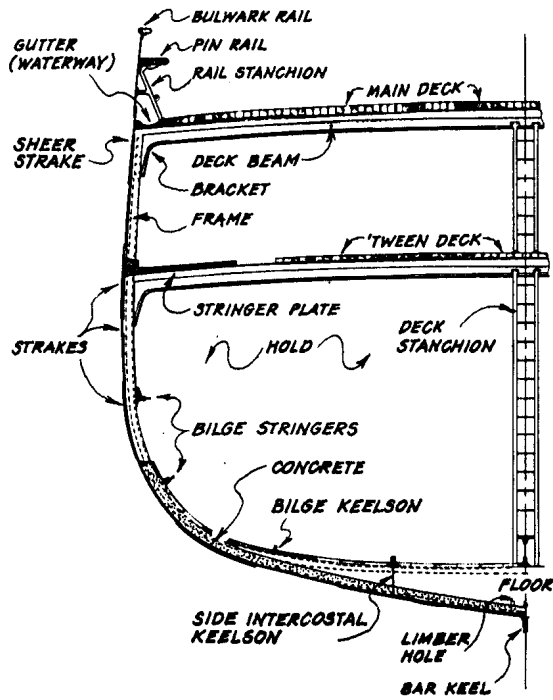
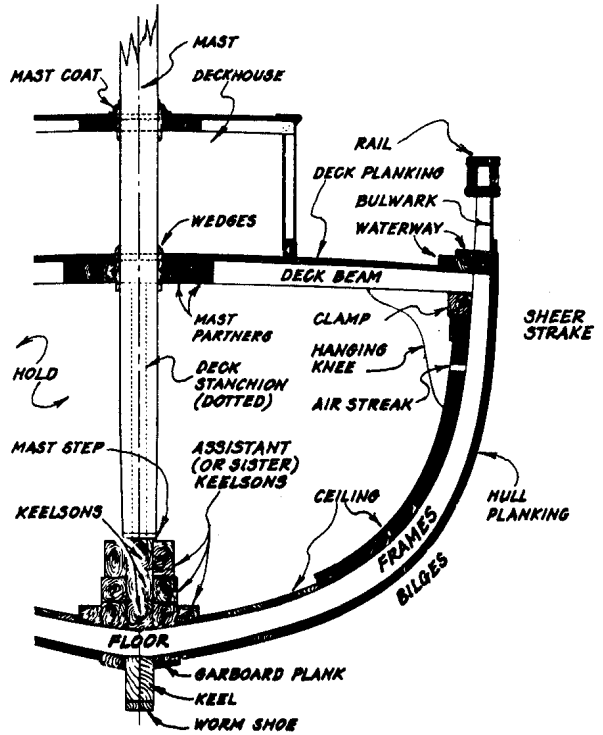

Fig. 4.2.2
The "Lines" or Contours of a Hull



Section through Metal Vessel



Section through Wooden Vessel

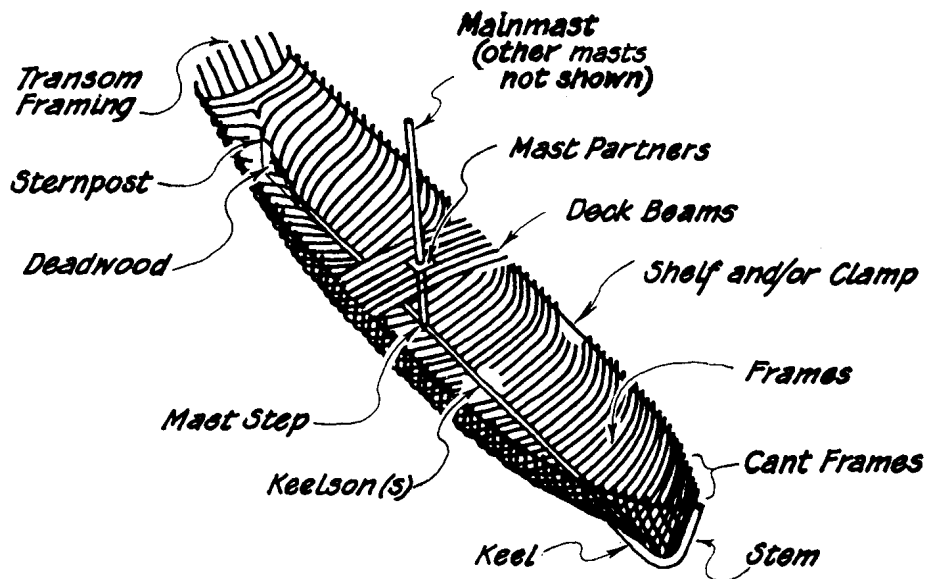

Sketch of Generic Wooden Ship Construction

Fig. 4.2.3
Basic Ship Hull Construction

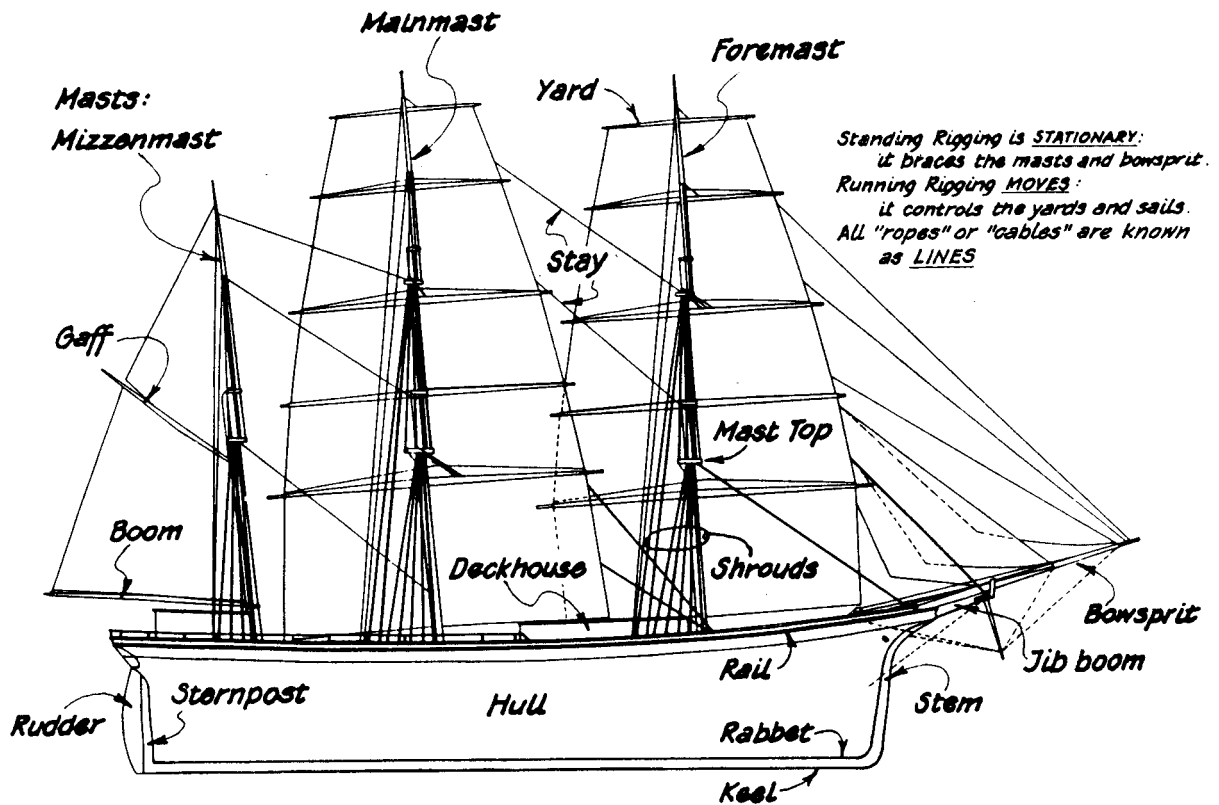
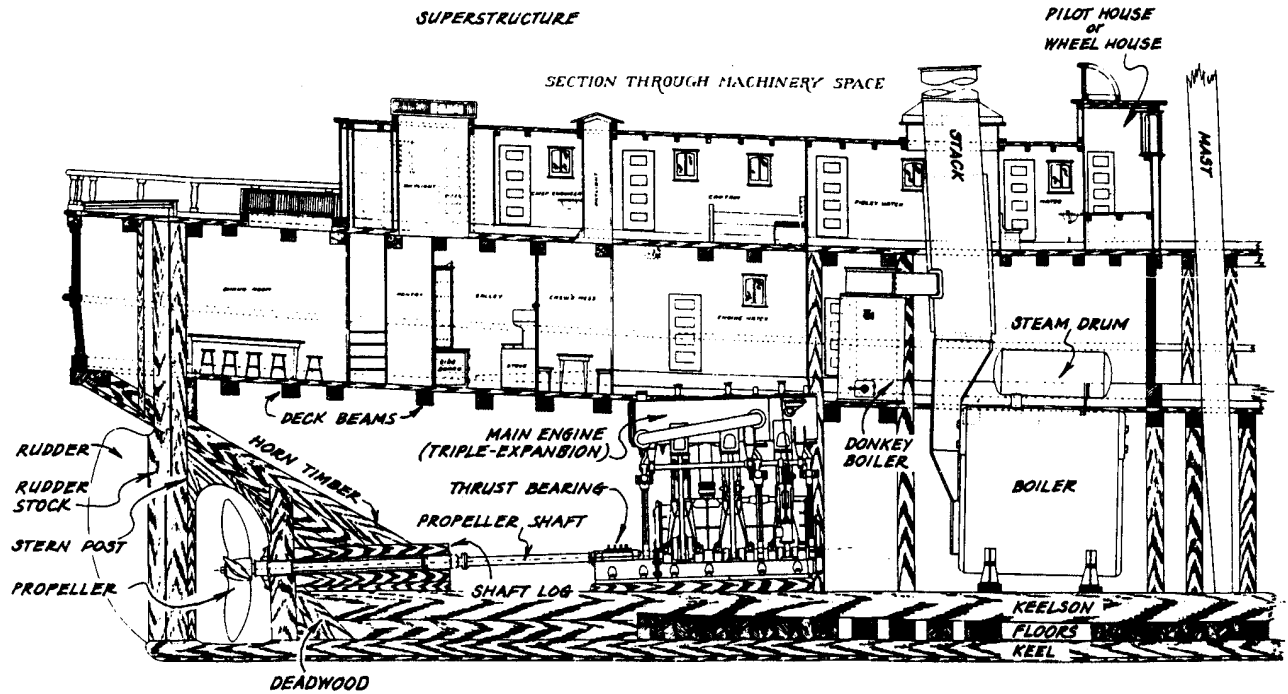

Fig. 4.2.4
Some Basic Parts of a Sailing Ship

(For further names of sails and various rigs,
see Section 4.9, "Some Basic Sailing Ship Rigs".)



Taken from Steam Schooner WILLAPA
HAMMS No. 16-33, Sheet 9 of 17

Taken from Steam Schooner WILLAPA
HAMMS No. 16-33, Sheet 10 of 17

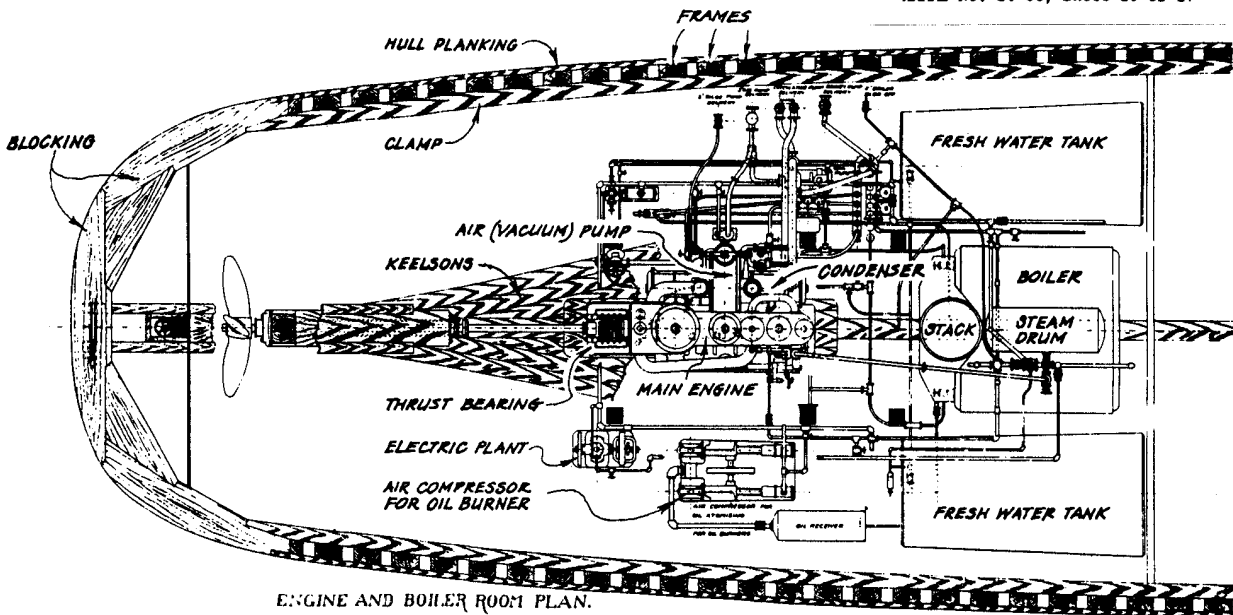

Fig. 4.2.5
Some Basic Parts of a Steam-propelled Vessel

FIELD METHODS

SIZING UP THE JOB

Any discussion of field methods for recording a vessel's structure and lifting her lines must begin with consideration of her attitude, size, and condition. These factors more than any others will control what general approaches to take in most circumstances, after matters of the vessel's significance and the project's purpose and scope have been settled.

Attitude. A ship heeled over in a mud flat obviously presents more problems to access and measurement than one blocked up level in a dry dock. Then there are situations in between, such as a vessel floating at a pier or sitting in a floating dry dock (where true level and vertical are always changing with respect to the vessel due to wind and waves), or a vessel blocked up on an inclined marine railway. Techniques for tackling each of these situations will be outlined shortly.

Size. The size of the vessel (and its internal complications) have obvious implications for the amount of work your team may need to do, and where your effort is directed. Time or money remaining constant, a larger vessel may receive less attention to some aspects and details (or none at all) in favor of others deemed more significant from the perspective of your project's goals.

Condition. Lastly, the vessel's condition may provide unusual opportunities or impose a number of limits on where, when, and how much data you can collect. A vessel in first-class order presents no glaring problems of safety (falling through rotten decks), attitude, or missing elements (large portions of the hull, decks, or propulsion systems gone). However,

many kinds of structural details may be inaccessible unless the team can discover some other source of information for these things--in builder's drawings, or specifications, for example. A deteriorating hulk may require a lot of educated guesswork, comparison with similar vessels, and reliance on other sources to create useful drawings. On the other hand, if conservation and preservation of the vessel are not intended, a planned program of dismantling the remains (subject to approval and guidance of proper authorities) may yield many valuable insights that would otherwise be impossible to get. Field work for archeological (submerged) sites will not be discussed, since methodologies have long been established in that discipline (see references under Nautical Archeology in Section 4.7).

Other Considerations. In planning your field work, keep in mind that time, budget, and team members' skills will significantly influence your choice of methods since they will govern the degree of expertise you can pay for and the sorts of tools and instruments the project can afford to buy, rent, build, or use with available manpower. Weather and even tides may dictate times of access. You may have to weigh the time and costs required to make specialized measuring equipment (such as large frames) against the rental of things like a transit and your team's skills and ability to use one to advantage. Different methods may save time without sacrificing accuracy. These are only some of the possible questions to consider when evaluating field methods and planning your approach. If your project has an advisory team, be sure to consult it for advice.

You should have your project's goals firmly in mind, and a preliminary schedule of final

drawings in hand before you go out to do field work. These will have obvious implications for how you spend your time; the level of detail to which a drawing set may go is heavily dependent on what is significant about a vessel and the goals of your project. HAER has found it advantageous to make “thumbnail” sketches of the layout and content of each prospective drawing sheet in advance of field work. It is also helpful to keep a checklist of specific features to cover as a hedge against overlooking important details. This may seem a bit premature if a significant amount of simultaneous historical research is planned, the results of which might affect the drawing schedule. However, certain basic views have been required traditionally for all vessels whose significance warrants the time and expense of measured drawings. In most cases, the time you spend in the field gathering information needed for basic views will give the historians time to pinpoint important details for notes or changes in the drawing schedule.

It is strongly recommended that the team’s field office be set up aboard the vessel if at all possible, or in an office space close by. There are a number of reasons for this, not the least of which is reduction of commuting time from office to vessel for investigation and measurement. On large vessels, a set of “walkie-talkies” may be great time-savers when conducting procedures (such as lines-lifting) which involve long distances or require part of the team to be in a space out of convenient earshot.

Terminology. Ship terminology may seem to be a world unto itself, especially when you begin to encounter the details of construction, rigging, etc. If you don’t know what something is called, or if you don’t understand what a new term refers to, ask. Review team members, shipwrights, and owners are usually quite willing to teach you these things. In addition, HAER strongly advises that you always keep a

comprehensive pocket glossary such as *The Lore of Sail* at hand for ready reference--knowledgeable people are not always around when you need them. Be prepared for local variations in meaning, pronunciation, spelling, etc., and be diligent about recording these terms in your field notes. Eventually, sea terms will come easily, and you will need to know them in order to make sense of records, drawings, shipwrights’ explanations, and the like without wasting time. Elementary orientation is given in Figs. 4.2.1 - 4.2.5.

BASIC VIEWS

Drawings of vessels fall into three groups: lines, construction, and interpretive drawings. Though some of the remarks below preview Section 4.6 (Measured Drawings), you should be familiar with standard views and types of drawings discussed below in order to make the best of your field work. Basic views include:

LINES (including Shell Expansion Plans)

CONSTRUCTION DRAWINGS

Outboard Profile – or Elevation (starboard side conventionally, port side if it is the only good one)

Inboard Profile – or Longitudinal Section (showing internal arrangement of structure, spaces, and equipment)

Main Deck Plan (often showing framing on one side of centerline, deck arrangement on the other)

Other deck plans

Sections (showing internal arrangement of structure and equipment)

Propulsion (sail and rigging plans and/or mechanical propulsion)

Details (structural joints, fasteners, fittings, joinery, machinery, carvings, etc.)

Scantlings, a list of structural member sizes and materials, should appear on one of these views.

Drawings may also include tables, diagrams, or other means of systematizing information.

INTERPRETIVE DRAWINGS (showing a function, process, or concept of a vessel)

Lines Drawings. Lines describe the shape of a vessel's hull. They are topographic views or "contour maps" of the hull's compound curves. They may indicate the outer surface of the hull or the outer edges of the frames. They are abstract in the sense that they sometimes give no indication of materials, fittings, or construction; however, lines drawings have often been combined with similar projections, such as an outboard profile or deck plan in which deck breaks, masts, rails, superstructure, rudder, keel, etc., are shown. Because they describe the shape of the vessel, lines must be drawn (or obtained from other documentary sources) before proceeding to some kinds of construction drawings, such as sections.

Great numbers of lines drawings exist for a variety of vessel types, thanks to the efforts of previous maritime documentarians. It may be that a suitable set exists of your vessel. However, HAER documentation is *vessel-specific*, and for this reason lines plans should not be overlooked. The use of lines from a half-model or another vessel is permissible but should be accompanied with notes on the HAER drawings explaining what the basis of similarity is. Field measurement of your vessel to verify claims of similarity may be a necessity, even if the team can show by documentary evidence that the vessel being recorded was built, for example, from the same half-model or plans as the similar one for which lines drawings have been discovered. Half-models and older drawings may have changed dimensions, or be mislabeled, and ships are not always built strictly to half-models or lines drawings.

Reconstructed or "As Is" Lines? Ordinarily, HAER draws an industrial or architectural structure "as is"--warts and all. However, it is

traditional to draw lines for a vessel as they would have appeared originally. No depiction is made of hogging, twists, or deterioration. A glance through the Historic American Merchant Marine Survey or the work of Howard I. Chapelle reveals numerous cases where hulks and remains were reconstructed in drawings. How one can produce a set of reconstructed lines from measurements of a distorted hull is discussed in Section 4.6 (Measured Drawings); however, it is usually necessary to draw the lines of a vessel "as is" before making corrections. If your project requires a detailed hull survey and the recording of "as is" conditions for study or repairs, then a set of "as is" lines will probably become part of the measured drawing set. Drawings done for HAER in such cases should include sets of both "as is" and reconstructed lines. In any case, it is important to explain how you derived the reconstruction from your field measurements in notes on your lines drawings. A more detailed description can be provided in your field report.

Construction Drawings. Construction drawings depict the physical structure and features of a vessel. In the past, this aspect of ship documentation frequently took a distant second place to lines drawings, or was ignored altogether. Historic ship construction cannot be so casually dismissed. Construction drawings range from overall views such as deck plans and inboard profiles to details such as structural joints of the hull and superstructure, carvings, fittings, propulsion, and deck machinery. They may or may not reflect existing conditions. What you concentrate on will be governed by your project's goals, the significant features of your vessel, and the kind and quality of pre-existing documentation. In requiring construction drawings of significant features, HAER is not seeking working drawings in the modern sense of a completely dimensioned, detailed description of every ship component suitable for construction purposes. In most cases the complete disassembly of a vessel for measurement is logistically impractical or philosophically objectionable, making a set of verified working drawings impossible. Many

areas of a vessel may be inaccessible or simply missing. Available dimensional information on structure must be included either as scantlings (see Fig. 4.7.12) or as notes on details, sections, or inboard profiles (see Fig. 4.7.13). Other notes and data should be included as described in Section 4.6. Old blueprints or shop drawings may be used to prepare HAER drawings, or photocopied for the HAER record. HAER drawings should be adaptable for facilitating repairs, reconstructions, or reproductions where owners and contractors must have drawings for cost estimates and construction work.

Interpretive Drawings. Interpretive drawings depict how a vessel works, what processes may be involved in operating it, or a design concept. These drawings include isometric, schematic, and illustrated views. Although not required to be measured drawings, the resources used to develop them should be noted.

MEASUREMENT ACCURACY

Precision in Field Work and Measured Drawings. Before describing methods of lifting lines or recording structure, there are some preliminary remarks about measurement methods and accuracy in field work that apply to all aspects of recording a vessel.

Precision and Error Tolerance. Precision can be a slippery word when measuring vessels--in some places it matters a lot, in others, little. It is possible to have a false sense of precision, like measuring barn doors with watchmaker's tools.

Theoretically, the maximum precision of a measuring instrument such as a tape is limited to $\nabla 1/2$ the smallest graduation on its scale. In the case of a tape graduated in 1/8ths of an inch, the maximum precision it is capable of is $\nabla 1/16$ ". However, in the real world objects like ships can rarely be measured to the precision a tape theoretically permits. The error tolerance ("∇") is usually larger (sometimes a lot) due to various circumstances. The appropriate tolerances depend on what vessel you are recording, her condition, which parts you are measuring, the tools you are using, and how you are using the information. To claim you have measured the 10' x 15' cabin of a yacht in first-class condition to $\pm 1/8$ inch is believable; to claim the same tolerances on a 100-foot long beached hulk is neither believable nor necessary. A tolerance of ± 1 inch on the length of a 150-foot vessel is understandable, but an error that size on a 6-inch frame in good condition is not.

Recording Your Accuracy. Appropriate precision in your measurements is important, and so is stating your tolerances, or reasonable estimates of error. Remarks on this subject apply to field work for both construction drawings and lines-lifting. Tolerances will become useful when you "fair in" lines or draw structure at the drawing board, but they are especially needed by those who later use your work--they need to know your work's limits as well as its content. Your field notes may also be consulted by future researchers interested in modelling or replicating your vessel. All measurements contain errors, some slight, some gross, and it is simply a

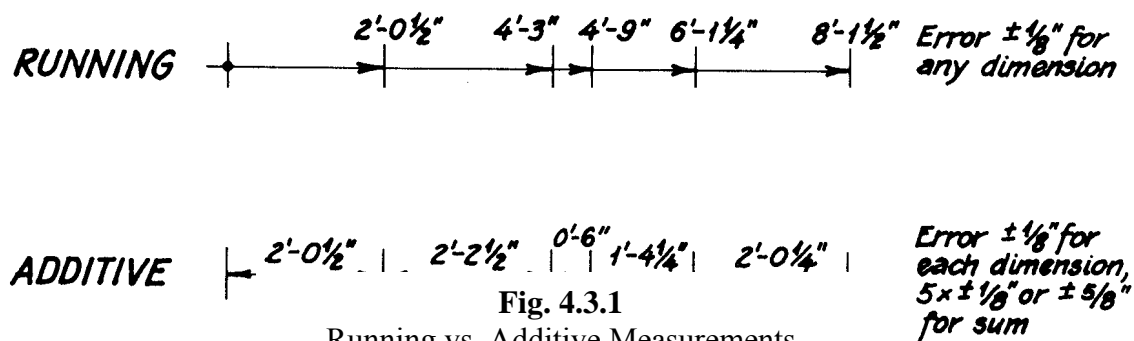

Fig. 4.3.1

Running vs. Additive Measurements

matter of professional responsibility as well as accuracy for you to note in your field records what your error estimate is, and what factors contributed to it. Errors are reduced by using running measurements (a series made from a single starting point) as opposed to additive measurements (the next beginning where the previous one ended). The error tolerance remains substantially the same for each measurement in a running series (all other conditions being the same), whereas the error in an additive series is cumulative (see Fig. 4.3.1). In the field tolerances can be enlarged by tape sag, irregular or decayed features, skill, etc. For hand measurement, it is better to use the "ideal case" as the *minimum*, then think of error as *relative to the total length measured*, and factor in circumstances (such as condition of fabric) accordingly. An error of 1/8" in 1 inch is 1 part in 8 (12.5%), whereas an error of 1/4" in 100 feet is 1 part in 57,600 (about 0.002%). Now an error of $\nabla 1/8$ " measuring a badly pitted steel rod is not too sloppy, but to claim an error of only $\nabla 1/4$ " in 100 feet on anything but a vessel in first-class condition begins to exceed credibility. Error should always be shown in your notes as " ∇X " (not "1 part in XXX"). Error for critical distances can be reduced by making the same measurement three or four times and averaging the results. Having said this, it should be pointed out that errors are present in final measured drawings due to several factors such as scale, fairing or averaging of curved features, thicknesses of ink lines, and delineators' skills. This is why finished measured drawings *must* show written

dimensions, preferably ones derived from the field notes, not scaled from the final drawing itself.

The following suggestions have proven invaluable in reducing hand measurement errors, both in lines-lifting and structural field work:

1) When a series of measurements is to be taken in a given direction (positions of vessel frames, locations of deck plank seams, for example), always make running measurements rather than measure element-to-element (see Fig. 4.3.1). For example, the position of each deck plank seam should be measured from the *same starting point* (edge of a covering board, for example), rather than measuring the width of each plank, plank-by-plank. This way, a $\nabla 1/8$ " error allowance in each measurement will still apply at the 20th plank, just as at the first. Error would be cumulative for additive measurements, so that the sum of 20 plank widths could be as much as $20 \times 1/8" = 2-1/2"$ in error--unacceptable over such a relatively short distance on a deck in good condition. This same principle applies to any series of measurements you may make in a given direction from a single starting point.

2) Make overlapping measurements and check measurements of large features which contain many small measurements (see Fig. 4.3.2). Such extra measurements serve to confirm the others, and may help you catch errors and quickly solve problems when you are at the drawing board.

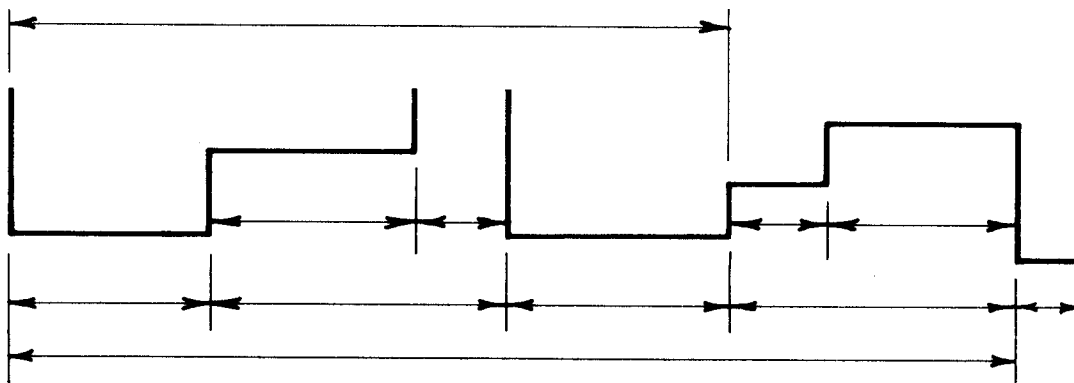

Fig. 4.3.1
Running vs. Additive Measurements

(3) Take care in how you read a tape or rule, especially if the scale is upside-down, or you are reading it right-to-left instead of left-to-right. It is very easy to inadvertently add or subtract an inch or even a foot from a dimension by reading the scale in the wrong direction. The numerals “6” and “9” can also be confused when the scale is upside-down. It may be very helpful to keep the rules or tapes you used to make measurements on hand at the drawing board. Being able to retrace the “look” of the scale at the point you took a dimension can solve problems when a recorded dimension appears to be in error. Keeping a log on your field notes of the brand and catalog number of measuring tools used may also help a future researcher solve a perplexing measurement problem.

4) Take care in how you record your dimensions or call them out to others. It is wise to insert a “0” whenever a foot or an inch dimension is less than “1” and to be rigorous in designating foot and inch dimensions. Often, common sense or “fit” to the drawing is not enough when trying to judge the applicability of something like 6’-1/2” at the drawing board. Aside from the confusion stray marks might introduce, should this be read “6 feet and one-half inch,” better written 6’-0 1/2”, or ‘6 and one-half *feet*’? Could it be the recorder got distracted when writing his dimension down and left the inch figure out? Using 0 1/2” would remove all doubt.

5) Dimensions should be recorded as they appear on the rule or tape you are using, whether it is in feet-and-inches or simply inches. It is suggested that you use equipment whose dimensions are given in feet-and-inches rather than inches alone. The architectural scales used at the drawing board are always in feet-and-inches, and you risk less error in drawing if you eliminate the step converting, say 59-1/4” to 4’- 11 1/4”.

As a point of interest, shipbuilders have long been accustomed to writing dimensions in a special format: all dimensions are written in feet,

inches, and eighths of an inch, each figure devoid of tic marks (‘ and “) and separated by a hyphen – 6’-0 1/2” would be written 6-0-4 in this case. If you are experienced with this system, use it.

LINES and LINES-LIFTING

Lines-lifting, for those unfamiliar with documenting vessels, is gathering the dimensional data needed to produce lines drawings. Lines are usually lifted from a hull’s exterior, though they can be taken from inside in certain cases, or even from half-models used for construction (assuming that the model hasn’t shrunk or been mislabeled). Any number of methods and tools will serve the purpose, depending on the accuracy desired, and on other situations discussed above. The “lines” themselves describe the hull’s shape as a series of intersections between the exterior hull surface and four sets of imaginary planes passed through it. (Some lines drawings describe the *inside* surface of the hull, even though measurements are taken from the exterior.) Three of these sets of planes are perpendicular to each other; the fourth is set at various angles. Each of these is described briefly below, accompanied by illustrations to help you understand what they are. Instructions for drawing lines are found in Section 4.6 (Measured Drawings), and examples of lines drawings are given in Section 4.7 (Drawing Examples).

Sections or **Body Planes** (see Fig. 4.3.3) are vertical planes that pass from side to side (“athwartships”) through the vessel, perpendicular to the vessel’s vertical centerline plane. The sections are probably the most easily understood, since they are to a vessel what slices are to a loaf of bread. Section planes are almost always set parallel to the planes in which the vessel’s frames lie. The section lines are the intersections between the section planes and the ship’s hull surface. They are always represented in drawings by a view called a *Body Plan*, seen from the ends of the vessel. Since symmetry is

usually assumed, half-sections from the bow to midship (forebody plan) are traditionally shown to the right and half-sections (afterbody plan) from the stern to midship to the left of a common centerline.

Water Line Planes (see Fig. 4.3.4) are horizontal and run fore and aft through the vessel, perpendicular to the vertical centerline plane and to the section planes. Water line planes are parallel to each other, but may or may not be parallel to the vessel's keel or floating water line, depending on the vessel's trim. In many cases, water lines are chosen so they lie perpendicular to the vessel's frames. *Water lines* are the intersections between the water line planes and the vessel's hull surface. In drawings they are always represented from above, usually for the starboard (or right-hand) half of the hull only rather than the full hull, since symmetry is assumed. This drawing view is called a *Half-Breadth Plan*.

Buttock Planes (see Fig. 4.3.5) are vertical and run fore and aft through the vessel. They are parallel to the central vertical plane passing through the vessel's keel and main deck centerline. The intersections between these planes and the hull surface are lines called *Buttock Lines*. In drawings they are usually represented from the starboard side ("dead abeam") in a view called a *Sheer Plan*.

Diagonal Planes (see Fig. 4.3.6) are planes passed fore and aft through the vessel. The intersections between the diagonal planes and the vessel's hull surface are lines called *Diagonals* and are used to help present curves in the hull surface which are not as easily or accurately understood from water lines or buttock lines. The diagonal planes are not necessarily parallel to each other. However, the intersections between them and the central

buttock plane are always parallel to each other and to the water line planes.

Because the concepts, traditional techniques, and procedures for lifting lines are pretty much the same no matter what a vessel's size or construction, they can be treated more easily and specifically than recording varieties of construction types. The following detailed treatment of lines-lifting techniques should not be misunderstood as emphasizing shape over construction.

In most cases, lifting lines involves measuring the vessel's bow and stern profile and taking sections at specific, recorded stations along the length of the vessel between the forward and aft perpendiculars (see Fig. 4.3.7). (Perpendiculars, as used here, are set at the extremes of the bow and stern along the vessel's centerline; they can be set at other locations--be sure your field notes indicate where.) In taking a vessel's lines, you are going after hull shape. Several approaches to locating stations are possible: dividing the distance between perpendiculars into closely spaced equal intervals, setting stations at frames, or just where hull shape alone dictates. In going by shape, sections should be taken at smaller intervals where the hull changes shape most rapidly (at the bow and stern); more widely spaced sections can be taken amidships (see Fig. 4.3.8). Sections and their locations along with bow and stern profiles (covered below) will give the important three-dimensional data needed to plot the lines. Once these curves have been plotted from field data, water lines, buttock lines, and diagonals are derived from them, so you do not face the prospect of actually measuring these things from the vessel itself.

Profiles of the sheer, stem, keel, stern, and rabbet line are necessary to finish out the lines drawings, because they provide termination points for water lines and sections. (Sheer is generally defined as the line where the outer surfaces of the hull and main deck meet; if you

SECTIONS

Fig. 4.3.3

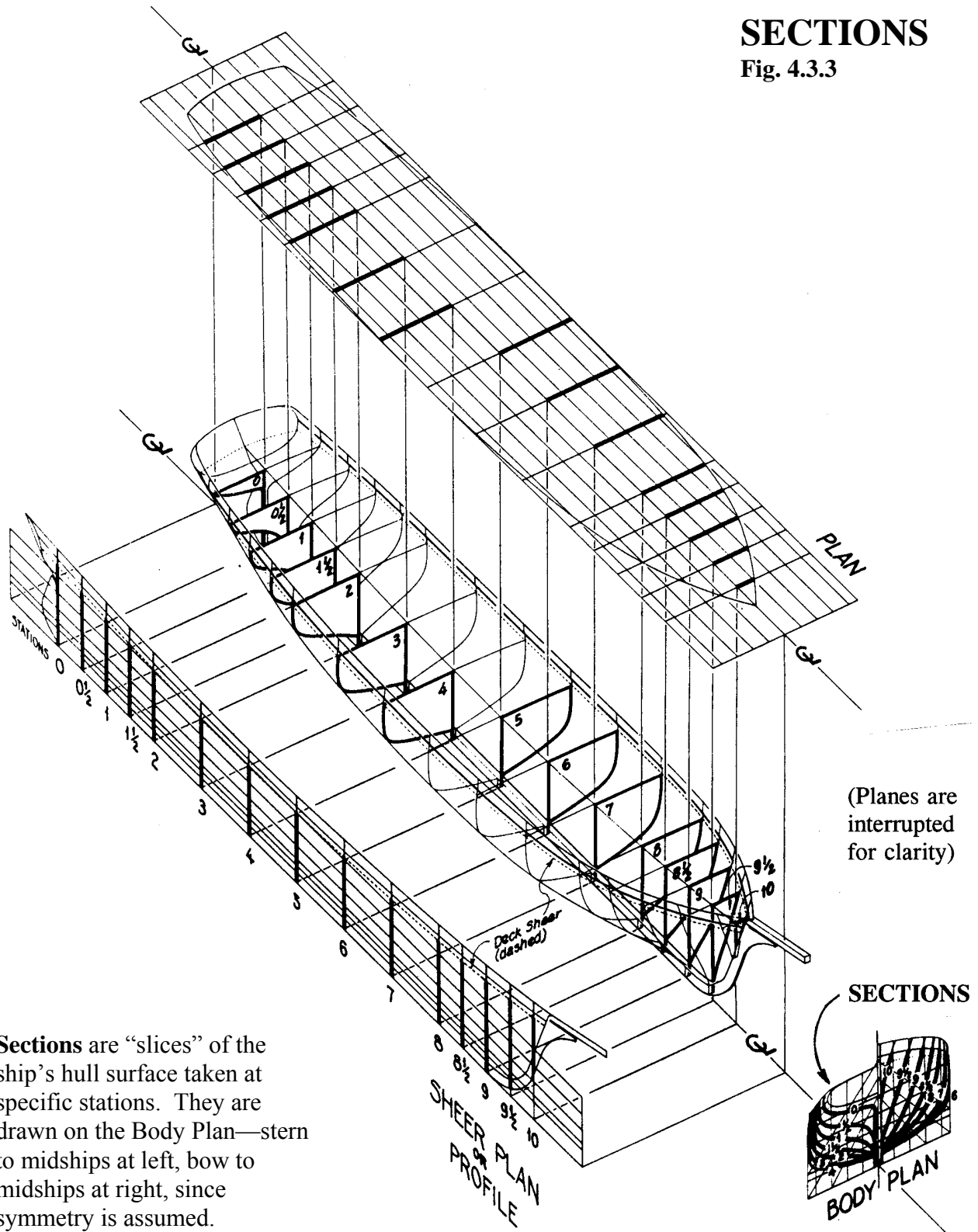

Sections are “slices” of the ship’s hull surface taken at specific stations. They are drawn on the Body Plan—stern to midships at left, bow to midships at right, since symmetry is assumed.

WATER LINES

Fig. 4.3.4

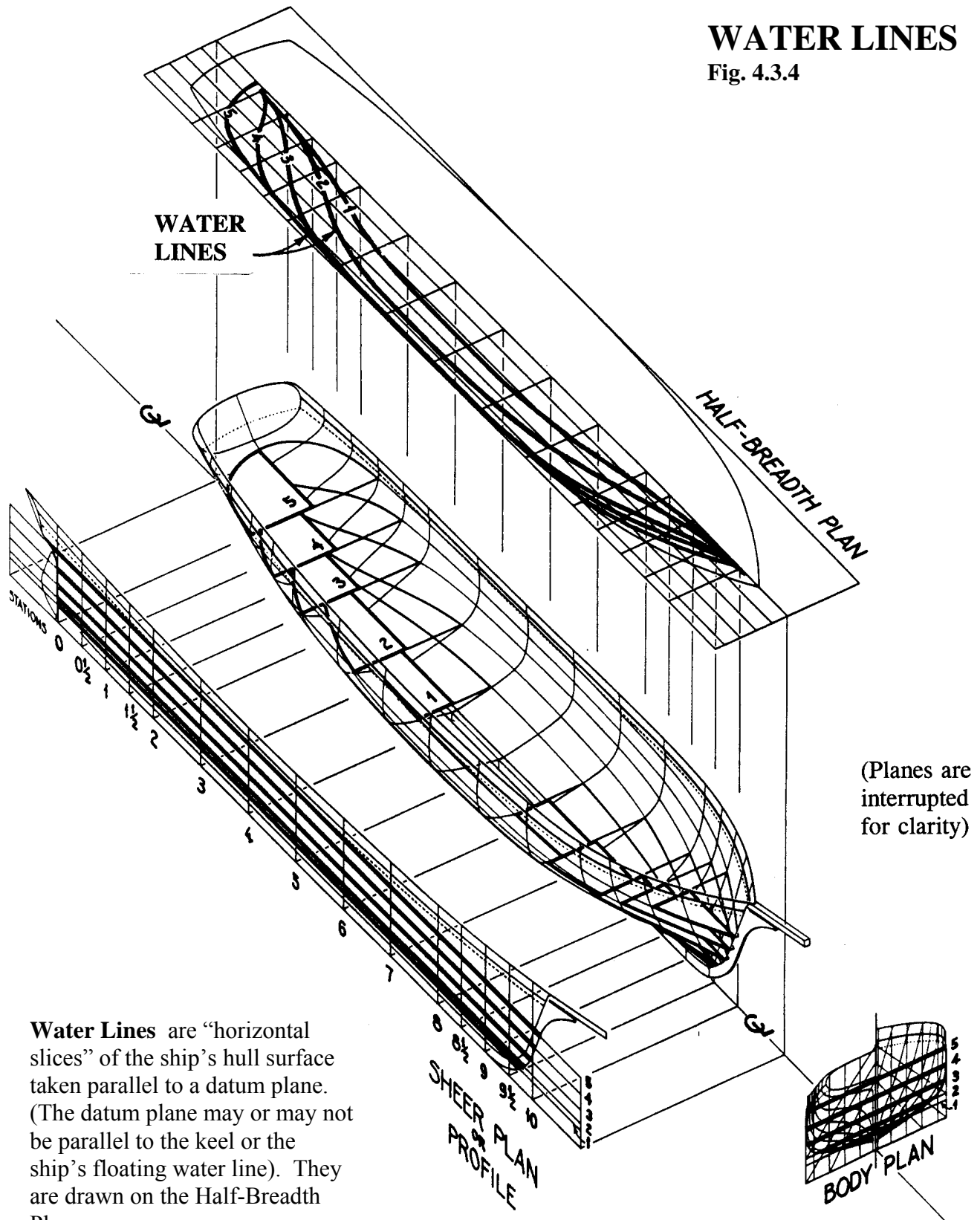

Water Lines are “horizontal slices” of the ship’s hull surface taken parallel to a datum plane. (The datum plane may or may not be parallel to the keel or the ship’s floating water line). They are drawn on the Half-Breadth Plan.

BUTTOCK LINES

Fig. 4.3.5

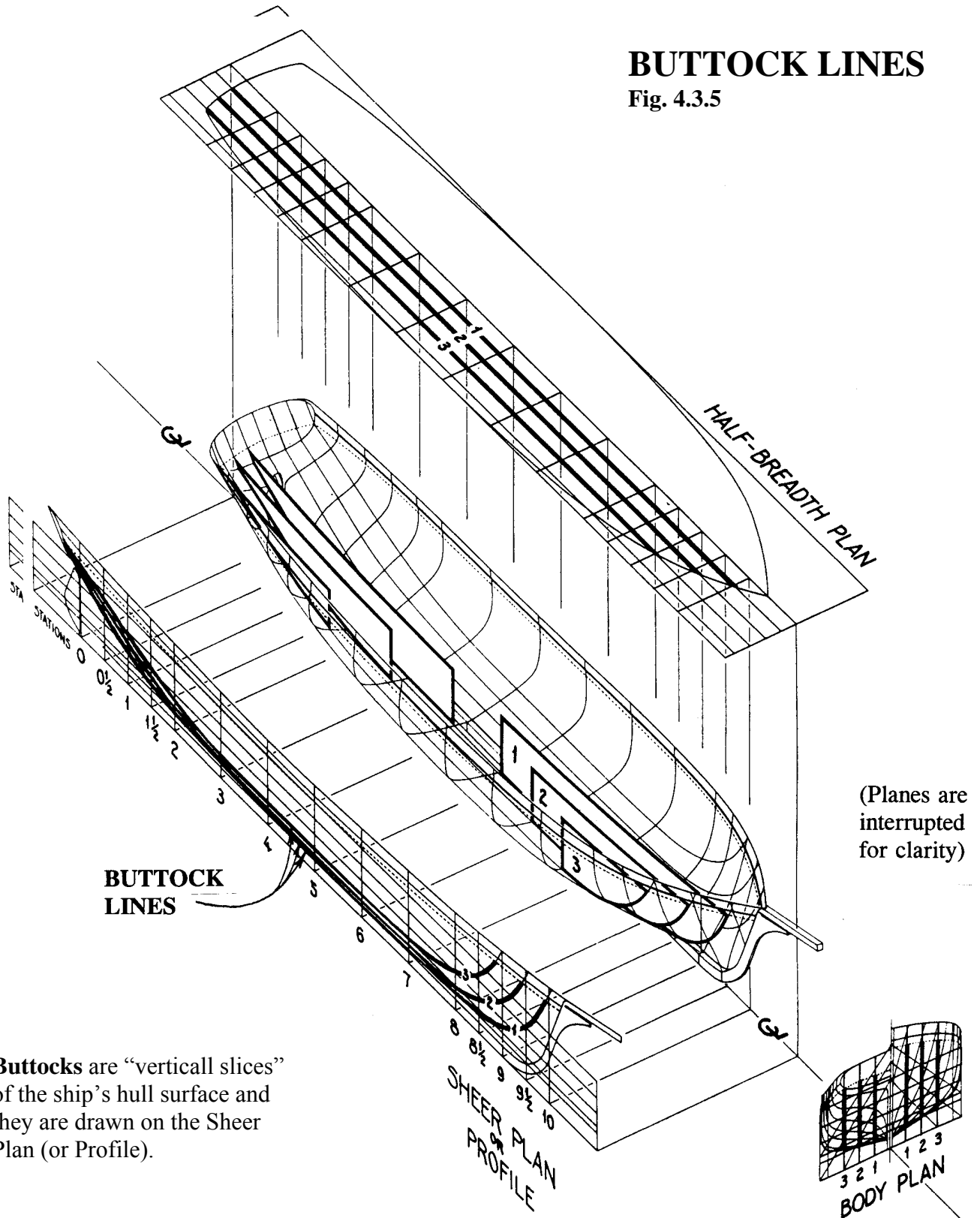

Buttocks are “vertical slices” of the ship’s hull surface and they are drawn on the Sheer Plan (or Profile).

DIAGONALS

Fig. 4.3.6

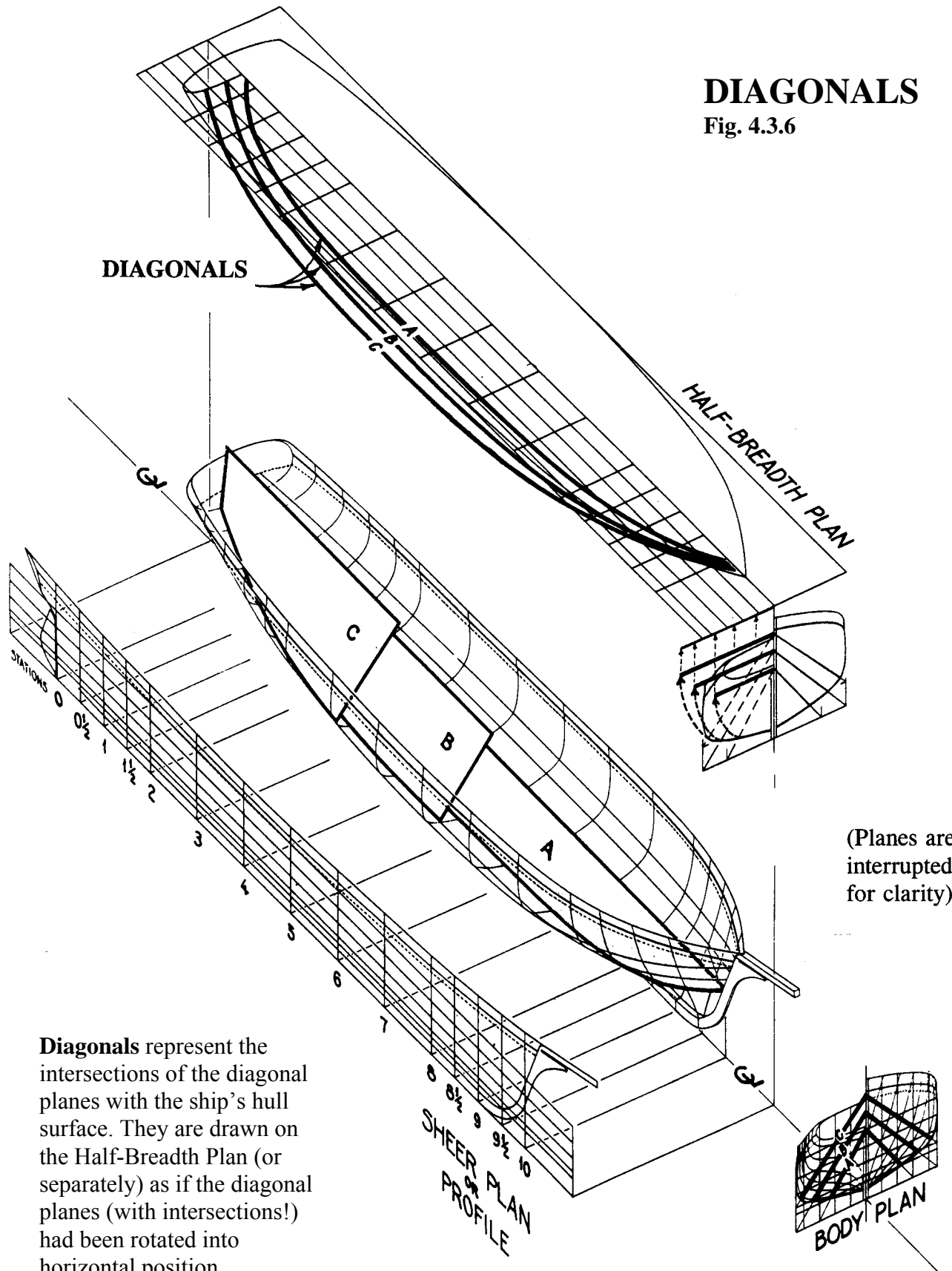

Diagonals represent the intersections of the diagonal planes with the ship's hull surface. They are drawn on the Half-Breadth Plan (or separately) as if the diagonal planes (with intersections!) had been rotated into horizontal position.

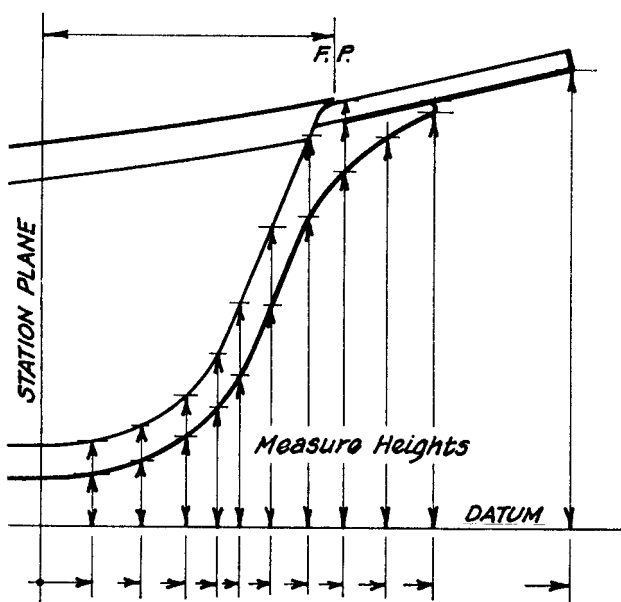

Fig. 4.3.9

Taking Profile of Stem

(Triangulations or quadrangulations are also useful; see Figs. 4.3.19-20)

encounter variations, be sure to define the usage in your documentation.) Profiles of hull features are fairly easy to obtain. For the stem and stern (including the rabbets there), all you need to do is pick specific points along these features, then find out how high the points are above the datum plane you are using, and how far forward or aft they are from given horizontal reference points (see Fig. 4.3.9). The horizontal reference points can be either lines-lifting stations or physical features on the hull.

The keel profile can be recorded as you lift lines, simply by including a column in your table for the dimension between the keel (or worm shoe) bottom and the datum plane. If the keel is straight, unworn, and has no drag, the datum plane could be defined as the worm shoe bottom, making this dimension zero (see Fig. 4.3.10).

In addition to locating sections along the length of the vessel, sections taken in the field must be

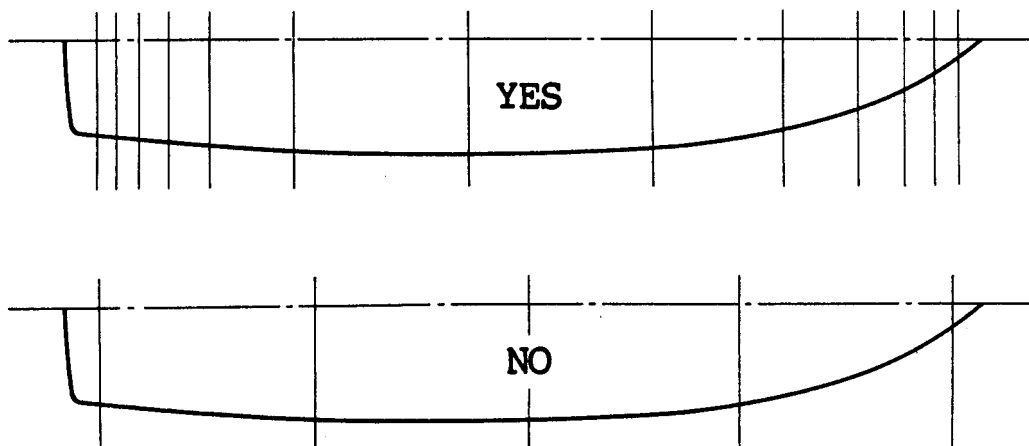
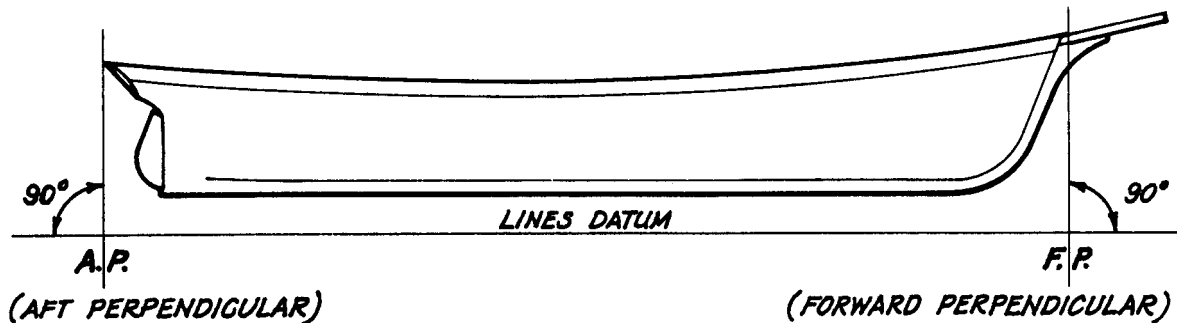

Fig. 4.3.8

Location of Stations

located vertically and horizontally with respect to each other (or to your reference system) in order for you to be able to make accurate drawings of the existing hull shape. Of the two, the vertical positions or “heights” are probably the more important to obtain, since designers and builders intend their hulls to be symmetrical. This does not mean symmetry shouldn’t be checked for in the field, at least by eye (for gross variances), if not by some check measurements. Port and starboard sections only need to be made if an especially detailed hull survey is planned, or if obvious distortions require both to be recorded in order to arrive at a reasonable approximation of the lines through averaging or other comparison. The discussions that follow do not assume that a hull is necessarily level and plumb.

There are two basic methods for finding heights:

1) The best method is to take all the sections (including the keel profile and sheer heights)

with reference to a straight datum line laid below or alongside of the keel (see Fig. 4.3.10). This method kills two birds with one stone: You get a keel profile as well as the sections all in correct relative vertical positions. If the vessel is in a dry dock or on a marine railway with a seemingly flat surface or smooth tracks, these could be adapted as datums for this work, but their suitability for this purpose should be thoroughly checked out. You may save time using the sightline of a transit scope, a string, wire, or some other substitute, if blocks and scaffolding do not interfere.

2) The second method is the opposite of the first, in some ways (see Fig. 4.3.11), and is more prone to errors. Here sections are taken from the keel bottom or rabbet line as datum lines, whether these features are curved or not (see Fig. 4.3.11). (This could be done with a horizontal scale lodged up against the keel or rabbet.) A vertical profile of the keel bottom and/or the rabbet line must then be made with reference to a separate but *straight* datum line in

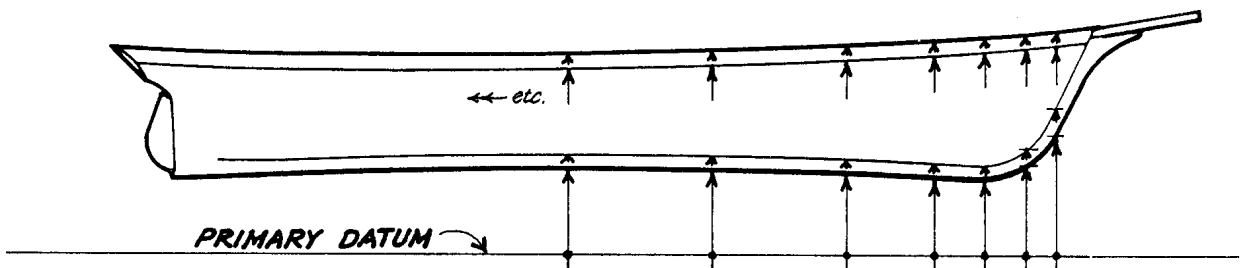

Fig. 4.3.10

Using an Independent Datum Line

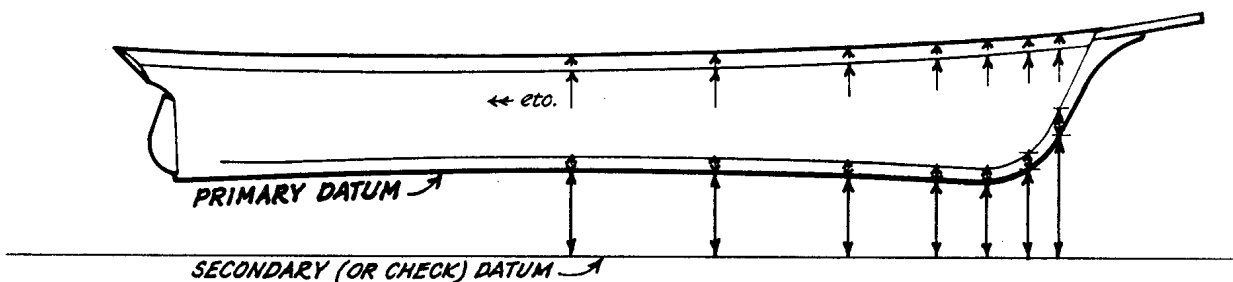

Fig. 4.3.11

Using Keel as Datum Line

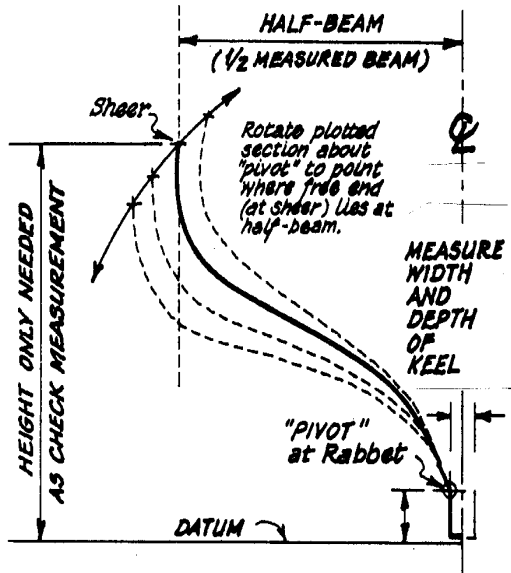

Fig. 4.3.12
Locating Section with Rabet and Half-breadth

order to properly line up the sections. (A vessel whose keel droops at each end is “hogged”—this is a

condition brought on by age or neglect; few vessels are built this way. Some vessels are built with “rockered” keels, so-called because they curve up at the ends. Many vessels will still retain the straight keels they were built with.)

The sheer heights can be double-checked by plotting a section from rabet to sheer, and locating the sheer at the half-breadth (horizontal component) of the sheer at that section. This closes a triangle, automatically establishing the height of the sheer (see Fig. 4.3.12). The height can also be double-checked by a transit survey of the main deck; this procedure is described later.

Horizontal placement of sections is established by the half-breadths of the sheer and rabet lines. The sheer line can be established horizontally by simply halving the breadth of the vessel at each programmatic reason to measure for asymmetry. The half-breadth of the rabet relative to the vessel’s centerline should be checked, since some keels vary in width along their ths. If asymmetry is present in the vessel and is important enough to be checked, there are at least two approaches one can take:

- 1) Stretch a string or wire fore and aft along the vessel, parallel with the keel, then make measurements at each station to the port and starboard sheer lines from this datum (see Fig. 4.3.13). While this datum should be set parallel to the vessel’s centerline, there is no reason for it to be at the centerline, other than for convenience. Indeed, masts and deckhouses may make a center location impossible.
- 2) Set up benchmarks and a datum line off the vessel, to which measurements are

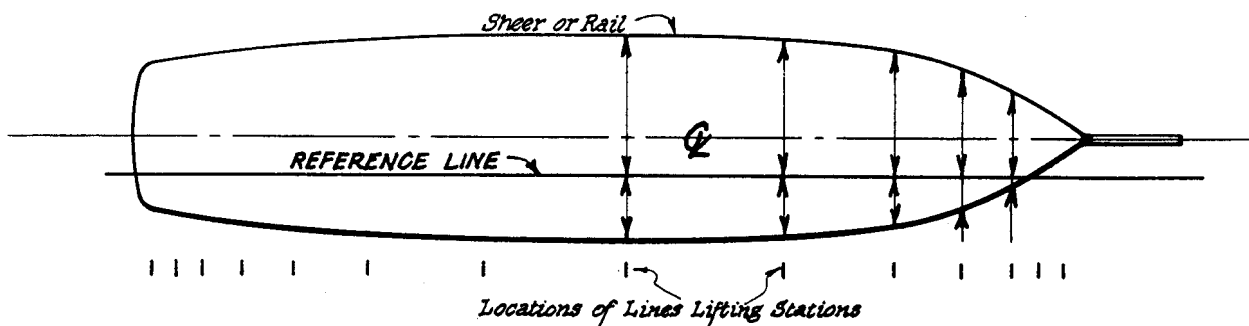

Fig. 4.3.13
Reference Line for Taking Beam Measurements

made and included in each section take-off for port and starboard sheer lines and rabbets. If the reference system you establish is consistently referenced at each station, any asymmetry or twists will be picked up and will be comparatively easy to plot. These methods assume that the keel is straight in plan. A hulk heeled over on a beach may have undergone a lot of bending as its hull deteriorated; the keel and hull may be twisted in both horizontal and vertical planes. Recording lines from such a vessel can be a nightmare, but a systematic approach in setting up a reference system and taking stations can go a long way to reduce the headaches at the drawing board.

BASIC LINES-LIFTING METHODS

Some basic lines-lifting methods will be outlined, intended for use primarily on large vessels (over 30 tons). These are hardly exhaustive in terms of the kinds of situations you may encounter or the sorts of tools and procedures you might use. You should be prepared to be creative in adapting these methods to your particular vessel, budget, team size, etc. Each of these methods is more fully described and illustrated as separate booklets under Section 7 (Case Studies). Projects conducted by HAER will in most cases have the field methods selected by the HAER office before the project begins, or methods worked out in cooperation with the field and review teams.

Before describing the methods themselves, however, there are a number of preliminary remarks to consider:

Hand Methods vs. “Black Box” or “High-Tech” Methods. The computer revolution has produced a number of electronic and photographic measurement devices whose potential for convenience, speed, and accuracy far exceed anything achievable by hand. These instruments can be quite expensive to lease or purchase, but what advantageous application might they have to lines-lifting (or construction drawings), and when should they be used? The

answers to these questions depend on what you want to gain by their capabilities. Prior to the electronic age, hand methods were the only ones available to record vessels, and noted authorities have made very good use of them. Their relative simplicity and cheapness ensures their continued use, and these guidelines are written primarily with hand methods in mind. However, “Black Box” devices and hand methods should be compared to gain an idea of their relative strengths and weaknesses. There can be projects where the trade-offs between costs of equipment and manpower, time, accuracy, safety, and other factors will dictate the use of such equipment. In many cases the trade-offs are complex, and no quick decision can be made. Some comparisons are made below, others in the descriptions of field methods given later. New developments should be studied, since they may offer simpler, cheaper methods for documentation.

Convenience. Convenience and safety may weigh in favor of the “Black Box” for large vessels where hand methods become cumbersome and time-consuming. If your organization owns “Black Box” equipment, there may be strong incentive to use it, since it is at hand. But don’t be overly lured by gadgetry. Setting up a “Black Box” so it can function properly or yield its full potential can require a lot of time, expertise, and patience. These can translate into inconvenience, especially if hand methods would be faster for the degree of precision you need. Failure to set a “Black Box” up properly can lead to less precision than hand methods would. Often the time you save in the field may be spent later in your office reducing “Black Box” data and other field notes to drawings. If you don’t need “Black Box” precision or speed, the time spent using hand methods may be more than made up by what you save in money and annoyance. In addition, you spend more time looking at and touching the vessel, which may lead you to learn more than if it were done remotely.

Speed. A variety of factors should be considered here when comparing hand and “Black Box” methods. Is your crew paid or volunteer? Are

you paying for expensive dry dock time? Is the vessel endangered? Would it take you the same amount of time to use hand methods as it would to train your crew to use “Black Box” methods competently and complete the job? Are hand methods more dangerous, thus slower, since you might have to climb carefully on hulls of uncertain strength? Is your field time limited by outside factors (dry dock schedule, money, impending demolition, etc.)? The speed “Black Box” devices offer may be a greater consideration than their cost, especially if loss of the vessel is imminent. Their capabilities may be critical, regardless of your vessel’s size and the time it takes to record it, if your project’s goals require a sort of archeological accuracy for a highly sophisticated program of studies, repairs, or reconstruction.

Precision. In general, marine workmanship places structural integrity and finish ahead of things like symmetry. For the speeds at which most historic commercial vessels sailed, minor variations in shape (two or three inches) would have had little effect on hull performance (though it is said some vessels were known to tack better on one side than the other!). The hull for an America’s Cup racing yacht has a much more finely tuned shape than a fishing schooner’s, for example, so in one sense you should be a lot more careful lifting the lines of a racing yacht when it comes to designed shape. It would be meaningless to precisely document asymmetry on an old schooner, whether by hand or “Black Box” methods, unless you had something more important than mere shape to demonstrate by it. Differences in hull symmetry might tell you something about workmanship, however. They may also reveal the effects of age or show the hull structure’s ability to withstand stresses. These can be clues to its condition, or to the quality of the vessel’s design, modifications, maintenance, or materials. If you are lifting lines with this sort of research in mind, you may need to measure to $\nabla 1/8$ ”, depending on the vessel. Careful hand methods may do well, but “Black Box” equipment might also be justified by its accuracy and speed.

While “precise” hull shape may not be critical in a lot of vessels, some frames or other major structural members might be prone to failure if variations like $\nabla 3/4$ ” were permitted in their cross sections, especially in metal members. This argues that you take care in measuring cross sectional dimensions ($\nabla 1/8$ ”) and that precision here is stricter than in lines lifting.

On a clean hull, most hand measurements can be made to $\nabla 1/8$ ” or $1/4$ ” when lifting lines, taking into account tape sag and other factors. Tapes are usually graduated in eighths or sixteenths of an inch. Digital surveying equipment can measure to the nearest 0.01 foot (slightly less than $1/8$ ”), and stereophotogrammetry is capable of the same level of precision. By the time the lines are plotted and faired from hand measurements, the difference between the shapes shown in the lines and the actual hull shape could well be $\nabla 3/4$ ” in some places. This is perfectly fine for recording the shapes of most hulls. Users of your work will ask themselves questions, however: Was the hull clean of barnacles and other growths? Is the vessel in good or poor condition? Did you work quickly or slowly (storm coming? dry dock time short?) or assume certain things for convenience that you couldn’t double-check? An error in a section of $\nabla 1/8$ ” to $\nabla 1/4$ ” inch measuring in the field is considered good for a clean hull and careful field work. Barnacles can throw you off to $\nabla 1/2$ ”. Deterioration and distortion can throw you off even more. Error tolerances apply to everything: datum lines, squareness of scales, etc. Notes should appear on your final drawings and a thorough account and analysis of these things should be written up as part of your field report. (Guidelines for writing a Field Report are found in Section 5, Field Reports.)

Location of Stations. Most of the methods described below assume that stations along the vessel’s keel are chosen and recorded carefully with reference to some easily recoverable benchmarks on the vessel (e.g., the sternpost).

Remember that in recording shape, you will need more stations where the hull shape is “quicker” (see Fig. 4.3.8). In some instances, it is useful to take sections at the frames of the vessel. You might be able to locate these from the exterior by looking for telltale patterns of bungs (wooden plugs covering spikes), rivets, or other fastenings that secure the shell to the frames, if paint doesn’t cover the fastenings up. Be prepared to look for a way to check the frames for plumbness or squareness to your final lines drawing reference planes. Be aware that the extreme ends of vessels may contain cant frames, which do not lie in a plane square across the ship. You should make a complete sketch of your vessel and its set-up (including benchmarks), and record exactly where your stations are taken. Photographs for the record are also useful. Field notes for your lines-lifting work are treated in the next chapter of these guidelines. Don’t forget to record the width of the keel at each station--it varies on some vessels.

How Many Points at Each Station? This depends partly on the vessel’s size, partly on her shape. On a large vessel it is usually sufficient to pick points about every 12 to 24 inches along the section line for measurement, but if in doubt, it is better to take more points than to have too few. More frequent points should be set where the hull surface makes a relatively abrupt change, such as the turn of the bilge. If there is a sharp “corner” in the surface (a knuckle or chine), measurements should be made directly to it (see Fig. 4.3.14).

Lines from Inside a Hull. Some vessels may permit lines-lifting from inside the hull. This would be a boon if the vessel is afloat, since there would be little need to take the vessel out of the water. Such an effort would be easiest in a vessel where nearly all frames are exposed on the interior, and little interior structure interferes

(see Fig. 4.3.15). In a large intact vessel with sawn frames, the frames can very likely be counted on to lie in section planes square to the keel or the vessel’s floating water line, obviously reducing the labor needed to establish lines-lifting stations. Be sure to check out whether this possibility is so before proceeding, however. The presence of bilge ceilings, decks, compartments, and finish surfaces can significantly impair such an effort, however, if not render it impossible. Cant frames are not suitable as guides in lifting sections because they lie in vertical planes set at angles to the ship’s central buttock plane. It is also difficult to derive an accurate picture of the keel width and keel bottom profile in this procedure. Lines taken from internal measurements should most likely be drawn this way (to the inside of the hull), unless you have a way to check the hull thickness for variations.

Lines from a Floating Vessel. All the procedures described in these guidelines assume that a vessel is out of water when her lines are lifted. Technically, it is quite possible to lift lines from a vessel that is afloat, using divers and some of the equipment and procedures described below. Such an effort seems unusual, but HAER resorted to it in 1989 when taking the lines of the *Lettie G. Howard* at South Street Seaport Museum in New York City. A frame 16 feet high and 22 feet wide was designed to fit around the vessel’s hull. Welded together from pieces of steel electrical conduit, the frame was hung around the hull from a wooden beam resting on the bulwarks. Trusses at the bow and stern strung two taught wires parallel to the ship’s centerline to align the measuring frame consistently at each station. A diver then assisted in obtaining coordinates for each point in the hull section described by the measuring frame. Further description may be found in the Case Studies.

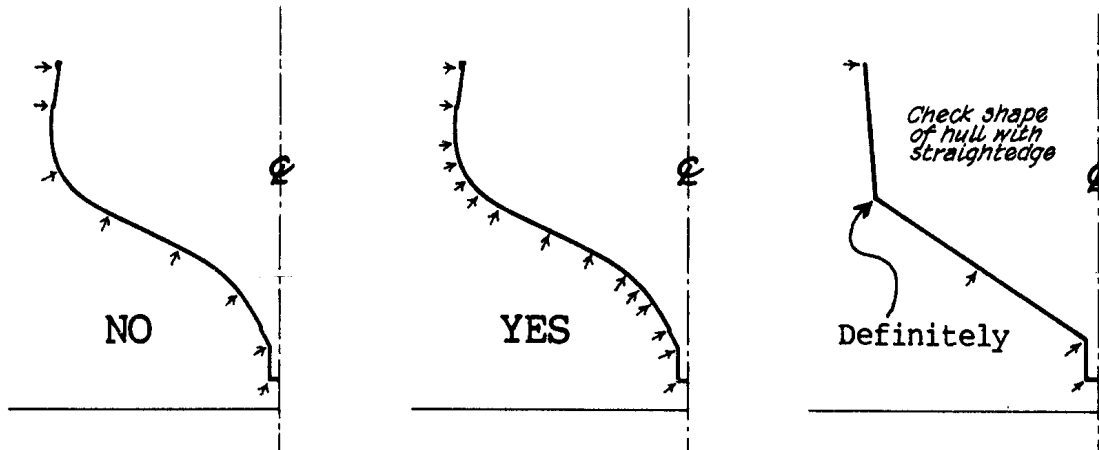

Fig. 4.3.14
Number of Points on a Section

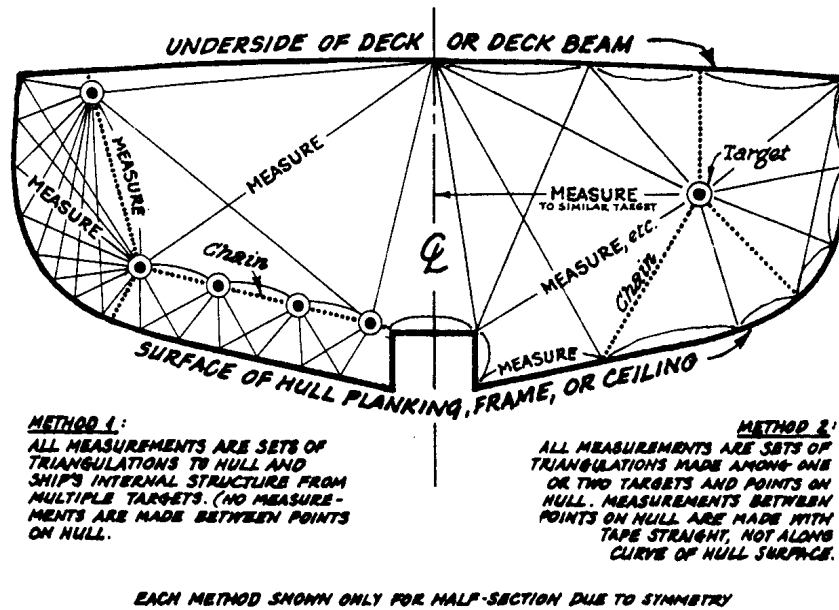

Fig. 4.3.15
Number of Points on a Section

GENERAL METHODS FOR HAND MEASURING

1) External Measuring Frames. This method is appropriate for use in a dry dock, marine railway, or other stable, relatively level location, though it can be adapted for use in the proverbial mud flat. A horizontal and vertical scale are braced and clamped square to each other, and from them measurements are made to points on the hull (see Fig. 4.3.16). This frame can be made from available (straight!) lumber, and the scales marked off on the parts, usually at one-foot intervals. (Some people may elect to clamp a brace at an angle on the inboard side of the frame and mark a scale on that, too.) The horizontal scale must be set level (a 48-inch mason's level will do) and square to the keel in plan. (Be sure to check and see if the *vessel* is level athwartships. If she cannot be set level, or is twisted, the variations in sheer heights must be measured so that these problems can be handled at the drawing board later--see the section on Measured Drawings.) The top of the horizontal scale should be set consistently at a datum line (string, chalkline on the keel, keel bottom if it is straight, etc.). The frame can be supported on sawhorses, blocks, or whatever is available. The vertical scale can be plumbed with a mason's level, or you might elect to line it up by eye at frames where rows of fastenings are evident, just to save time. Use of a plumb bob and string can be problematical on windy days--suspending the plumb bob into a bucket of water can dampen the swing and shield the bob against the wind. On inclined marine railways, the vertical scale may have to be inclined in order to keep it square to the plane of the keel bottom or chosen datum line. Fitting a compensating wedge to your level will allow you to keep this inclination consistent station to station, or it may be expedient to erect a second, fixed frame from whose top and bottom the moveable frame is positioned by taping.

Measuring the Hull. Measurements from the frame to the hull can be taken numerous ways. Your team might find it faster to use more than

one of these methods at the same time. In any of them, however, measurements must be made from the frame to the hull *in the plane of the section*. (Do note that these measurements are not necessarily square to the hull surface, especially at the bow and stern. The measurements *must* be taken in the plane of the measuring frame.) Since the vertical and horizontal scales of the frame lie in this plane, it is a simple matter for a team member to stand to the side of the frame and "eyeball" the end of a tape (or stick rule) to its proper contact point on the hull in this plane. Subject to the vessel owner's permission, a chalk line could be made on the hull, guided by the team's "eyeballer," to show where the section lies, but this can be an unnecessary waste of time, especially on large vessels. If a hull expansion is to be drawn, however, such chalk lines are indispensable. (Hull expansions are described later.)

Points with a Stick Rule. The simplest measurement is made with a stick rule projected square from the scales at their buttock or water line marks (see Fig. 4.3.17). It is recorded in a table that shows both the measurement and the

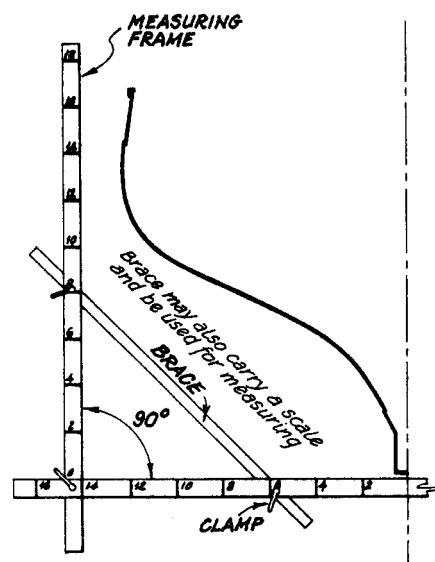

Fig. 4.3.16
Taking Sections
with External Measuring Frames

number of the buttock or water line mark from which it is made (see Field Notes, Fig. 4.4.5). This method is good when distances to the hull from the scale are less than two feet. Beyond this, it becomes cumbersome, especially from ladders. In principle, it could work for any distance from the scale, but in practice, extra helping hands are required for a long tape or rod. Also, it can become difficult to insure squareness to the scale in the field, and measurements can become inaccurate when the angle between the tape and the hull is less than 30 degrees.

Points with a Plumb Bob. For measurements from the buttock (horizontal) scale, a plumb bob might be suspended from the hull to the scale in cases where the section plane is truly vertical (this method is of no use if the section is inclined, for example, on a marine railway). Alignment of the suspension point on the section line is automatic when the plumb bob is set over a buttock mark on the scale (see Fig. 4.3.18). The dimension from the suspension point to the mark is then recorded in a table along with the buttock number. This method has its limits if it is windy, and when you approach the turn of the bilge. Like the horizontal measurement with a stick rule, it loses its accuracy when the angle between the hull surface and the plumb line is small: a slight error horizontally leads to a much larger error vertically.

Points by Triangulation. Triangulation, or even quadrangulation from the frame eliminates many of the limitations encountered with plumb bobs and simple offsets (see Fig. 4.3.19). A point on the section line along the bottom of the vessel may be triangulated to the buttock scale by pulling a tape from the point to each of two widely spaced buttock marks and recording the respective distances and buttock numbers in a table (again see Field Notes, Fig. 4.4.5). This applies similarly to points on the side of the vessel measured from the water line scale. The effort can be speeded up by using two tapes secured at their ends to a long pole; the pairs of measurements can then be made more or less simultaneously. Take care to keep the angles

between the tapes greater than 45 degrees, however. At acute angles, small errors in reading or plotting one of the dimensions can mislocate a point by several times the error. Try it and see!

Points by Quadrangulation. Quadrangulation is simply a modification of triangulation (see Fig. 4.3.20). When recording a point, one tape is pulled to a water line mark, and the other to a buttock mark, with dimensions and positions suitably recorded (a pair of binoculars can be handy for reading tapes at high water line marks). There is no need to keep the tapes square to the scales, though an angle of 90 degrees between the tapes themselves is best. This technique is especially useful at the bow and stern of a vessel, where the hull surface is at some distance from the measuring frame and triangulation may give you too acute an angle between tapes. Aside from reading the tapes properly, the accuracy of quadrangulation depends on the vertical and horizontal scales being kept dead square to each other from station to station.

Sheer and Rabbet Lines. In addition to offsets, both the rabbet and sheer line must be recorded, since these are the endpoints of the section lines (see Fig. 4.3.21). The rabbet line is the intersection between the exterior surfaces of the garboard plank and the keel (see Figs. 4.3.21-22). The sheer line is generally understood to mean the intersection of the exterior surfaces of the hull and main deck. It does not necessarily have to coincide with an exterior feature of the hull. In looser usage, a sheer line is a somewhat flexible term which refers to the fore-and-aft sweep of the deck (and parallel features such as wales, cap rails, etc.). For convenience, the sheer line in your notes and preliminary measured drawings can be the underside of the cap rail, a bead, the sheer plank, the intersection between the main deck surface and the exterior hull surface, or even the underside of the deck planking at the ship's side (plank sheer). Ease of definition should be your guide, but whatever you choose to call the sheer line should be used

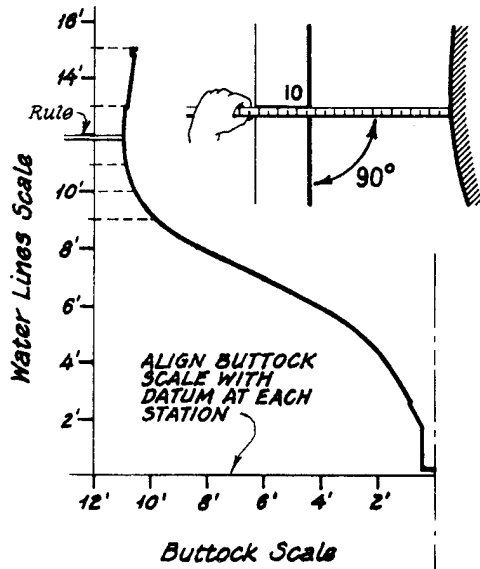

Fig. 4.3.17
Points with a Stick Rule

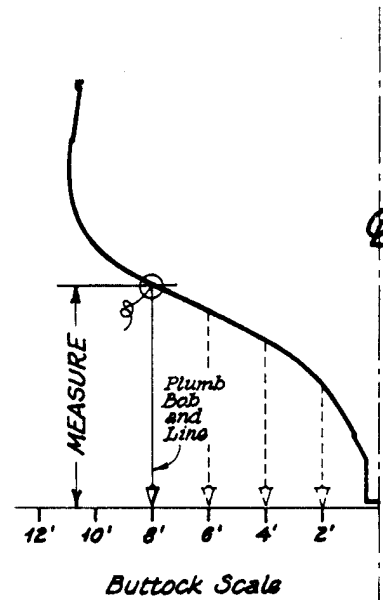

Fig. 4.3.18
Points with a Plumb Bob

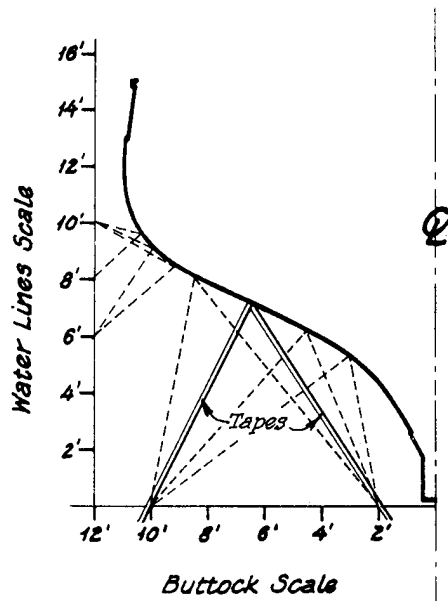

Fig. 4.3.19
Points by Triangulation

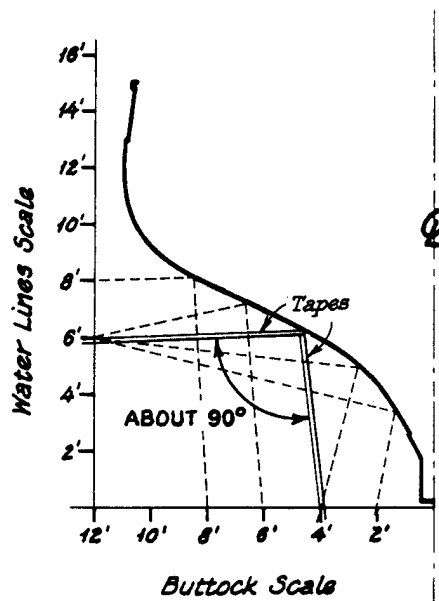
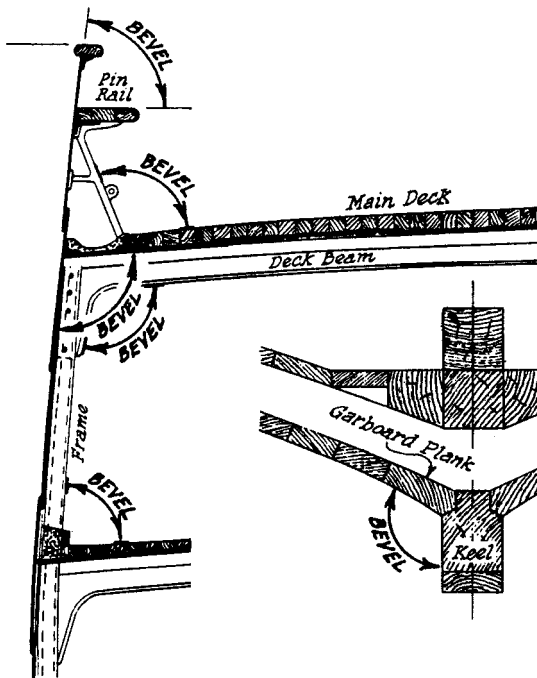

Fig. 4.3.20
Points by Quadrangulation

first above should be shown.) It is important to measure the beam (port sheer line to starboard sheer line) of the vessel at each station, as well. This is later used as one kind of check against mispositioned sections due to the vessel not lying level athwartships, or being twisted. If asymmetry in the hull is not a problem, the beam dimension is simply halved at the drawing board, and used to locate the offset of the sheer from the central buttock plane.

Bevels. As a check against errors, it is wise to take bevels at every station. A bevel is any angle between two features. On a wooden vessel, you might take the bevel between the garboard plank and the keel (see Fig. 4.3.22), or between the hull and main deck at the sheer, or between a frame and deck beam inboard. A bevel need not be actually measured with a protractor, though if one is available, use it. A carpenter's bevel gauge (which consists of two hinged arms with a lockable hinge pin) can be adjusted to the angle of the bevel and the angle transferred directly onto a field note sheet for measurement at the drawing board.

Fig. 4.3.22
Examples of Bevels



consistently throughout all parts of your preliminary work to avoid confusion. (In final drawings, the sheer line as generally defined

On-site Verification. Every section should be plotted on site to verify the data before the frame (or any set-up) is moved to the next station. At the drawing board, each section is plotted by first drawing the measuring frame to scale. Simple offsets are drawn square to the frames. To plot a triangulated point, a compass is set and an arc drawn for each of the two recorded legs of the triangle (or quadrangle). The intersection of the arcs is the point location. This is repeated for every point before the section line is faired in through as many points as will fit along a smooth curve. Any points or series of points showing considerable misalignment from the curve should be checked and, if necessary, remeasured. Plotting lines is more fully discussed in the section on Measured Drawings.

There is no reason why the sort of measuring frame discussed above could not be adapted for use under other conditions, however, the set-up time required will increase where vessels are

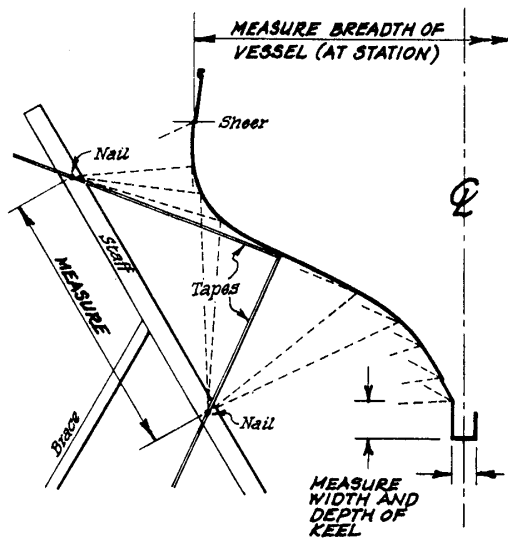

Fig. 4.3.23

Taking Sections with Staff and Tapes

skewed (e.g., lying in the old mud flat), or where it is less practical to carry large pieces of equipment such as squares and sawhorses. (See Section 6 [Case Studies].)

Many of the above remarks apply equally well to the other methods discussed below.

2) Staff and Tapes. Ideal for mud flats and out-of-level vessels. Equipment is simple, easily portable (compared to a large measuring frame), and it can be adapted for use anywhere, though it does present some set-up problems. The staff is simply a piece of sturdy lumber long enough to brace securely and set two nails on 8 to 10 feet apart (see Fig. 4.3.23). This dimension may be greater for large vessels, less for smaller ones; it must be accurately recorded in all cases. The guidelines discussed earlier for choosing station locations at which to set the staff apply here as well. The staff can be driven into the ground, nailed or clamped to haul blocks, or attached to the vessel somehow by outrigger braces clamped or nailed to the cap rail and keel. Each point in a section is located by triangulation from the two nails. Plotting the points is the same procedure as discussed for triangulations above. The relative angle of the

staff to the vessel in the section plane is not critical, though an angle of about 45 degrees from the central buttock plane may be best. Ideally, the shape of each section can be properly plotted even though the position of the staff varies from section plane to section plane. However, once the staff is set up for a given section, the entire section must be recorded from this position, or you will not be able to plot it without a lot of extra trouble. Recording the beam at each section and the rabbet and keel profiles is essential to this method. Sections plotted only from the staff merely float in space until endpoints at the sheer and rabbet lines are established with this crucial data. A weakness of this method lies in the triangles created at the extremes of the section. The acute angle between the tapes can magnify measurement and plotting errors. This problem can be mitigated by making the distance between the nails larger relative to the distance of the staff from the hull (or even by adding more nails to the staff). It is also much more difficult to eyeball the tape ends in toward the hull in the section plane with this method than with external measuring frames.

Set-up problems stem primarily from difficulties in aligning the staff with the section planes. If the vessel you are measuring is skewed (heeled over with one end higher than the other), it may take some extensive geometric thinking and planning to even set the section planes up square to the ship. If the vessel is greatly deteriorated, the prudent thing to do may be to simply eyeball it, but any lines drawings based on such “guesstimates” must carry notes to that effect. It is possible to plot lines from section planes set at angles to a datum line or to the central buttock plane or the keel, but these angles must be measured in order to draw these skewed sections accurately for later transformation into proper projections. In such cases, it will involve considerable effort and skill at the drawing board to avoid confusing the numerous lines and projections with each other. Under some field conditions you may have no other choice than to take skewed sections, but it will prove more accurate and less frustrating to simply take the

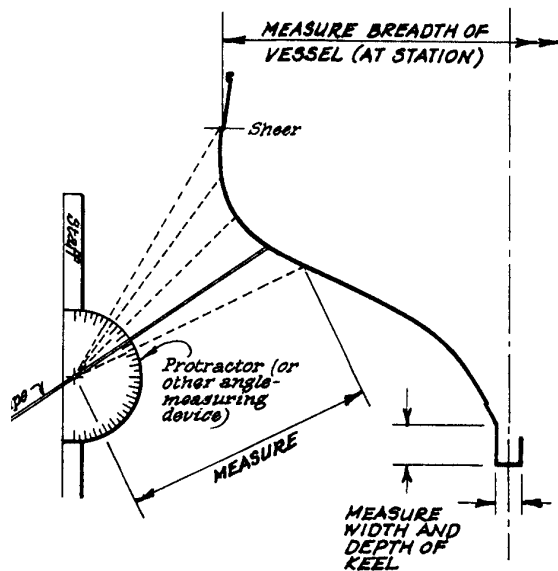

Fig. 4.3.24

Taking Sections with Range and Bearing

time to set up and record “true” sections in the first place.

3) Range and Bearing. This method is useful anywhere, but has some serious weaknesses that make it best used on small vessels unless a surveyor’s transit is handy. As a hand-measuring technique (with protractor), it is the poorest of the three methods covered so far. It is reviewed here in part because it has been used in the past, and others may decide to use the method without knowing its weaknesses. Critical equipment consists of a protractor (or some angle-measuring device) fixed to a staff or frame, and a tape (or other distance measuring device) secured to the radial center of the protractor. Points in a section plane are located by recording their distances from the protractor center and the corresponding angles read from the protractor where the tape crosses the protractor scale (see Fig. 4.3.24). As with the staff-and-tapes method, an entire section must be plotted from a single set-up, and recording the sheer and rabbet lines is crucial to locating the curve relative to the ship’s center plane and base plane. The accuracy of the

protractor (in part a function of its size) is essential to the method’s success. Depending on the size of the vessel, a small error in angular measurement can produce a serious error in point location. This is why this method is perhaps best used on small vessels if you do not have access to a transit. A transit is capable of much finer angular measurement than you can perform by eye with a protractor.

Larger projects will benefit from substituting a surveyor’s transit for the protractor, using the scope sightline to sight in points and recording the angles from the instrument’s precise vertical circle. A tape (or electronic distance measuring device) must be used to record distances from points to the scope pivots. You will encounter set-up problems similar to those of the staff-and-tapes method, chiefly ones of aligning the equipment with the section plane at each station. Use of a transit will be most productive in cases where the ship’s keel or a wisely chosen water level plane is level, since the instrument is not designed to be easily adjusted to non-horizontal planes.

Transoms. When taking lines, a vessel’s transom (or round stern) must also be measured. Usually only buttock lines for a transom are drawn, in addition to the transom shape as projected into profile, half-breadth and body plans. A separate transom expansion may also be necessary (see Fig. 4.6.29 for examples of various transom expansions). Transoms (not round sterns) are usually flat vertical or inclined planes or planes bent to a radius along a vertical or inclined axis. Age and repairs may alter these simple geometries, however.

The set ups for measuring a transom are analogous to those for taking hull sections--the transom is sliced in planes like a loaf of bread, only these planes are *parallel* to the ship’s vertical centerline plane rather than perpendicular to it as with hull sections. The intersection between these planes and the

transom can be measured with the same methods used for hull sections. The buttock planes are usually evenly spaced from the centerline plane. If you know what buttock planes you will be drawing in your lines drawings, lay these planes out full scale under your vessel. Otherwise, lay out at least three parallel lines (strings) to each side of the vessel's centerline; pick an even spacing like 18" or 24" for convenience

Measuring Transoms with a Plumb Line.

After laying out buttock lines, a plumb bob can be suspended from the end of a pole, and the pole end positioned along the top and bottom of the transom at points that align the plumb bob with the buttock lines below (see Fig. 4.3.25). When the plumb bob lies over a buttock line, mark the transom edge at the point from which the plumb line is suspended. This procedure projects the buttock lines vertically through the transom. If you wish, each plumb bob position can be marked on the buttock lines at the same time as the transom is marked. The marks on the strings can then be measured from some transverse line marked at 90 degrees across the buttock lines. This will yield port-to-starboard and fore-and-aft coordinates for each point on the

transom edge. The vertical coordinate must be measured from a known datum plane (such as may be described with a transit) or measured between each transom mark and the corresponding mark on the buttock line plumbed beneath it. Later, the vertical elevation of each buttock line mark must be measured relative to a datum plane, or the vertical coordinates cannot be properly plotted.

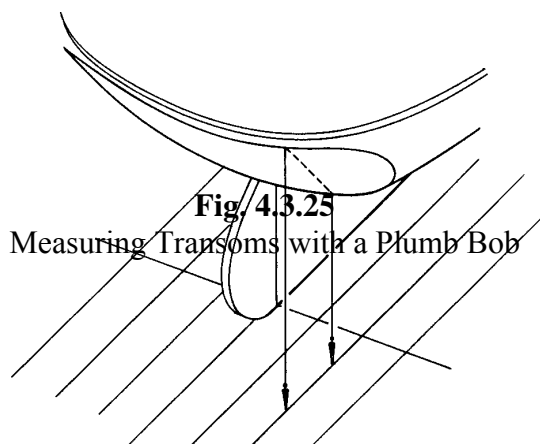

Fig. 4.3.25
Measuring Transoms with a Plumb Bob

Measuring Transoms with Triangulations. If using a plumb line is inadvisable or cumbersome (due to obstructions or wind, for example), triangulation from points on the buttock lines to the transom edges may be a viable alternative (see Fig. 4.3.26). The triangulation points on the buttock lines can be established as the intersections between the buttock lines and two lines laid at 90 degrees across the buttock lines fore and aft of the after perpendicular. As with the plumb line points, the elevation of the triangulation points must be measured relative to

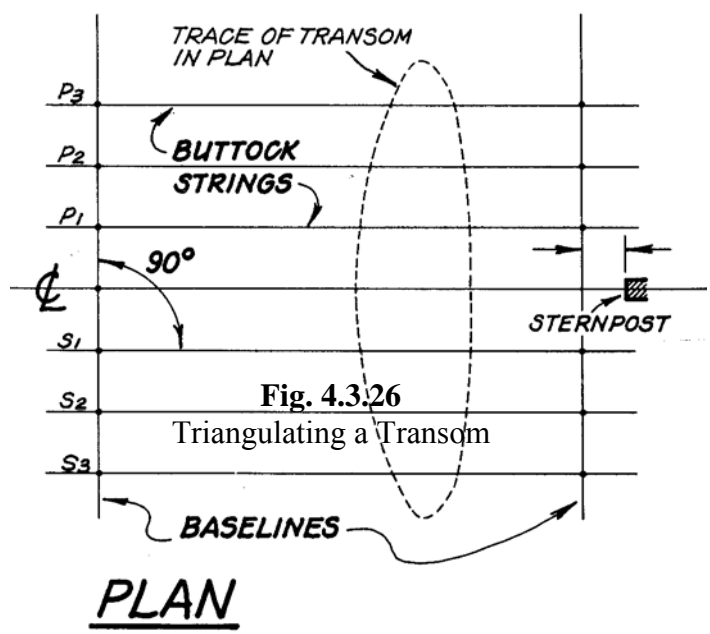
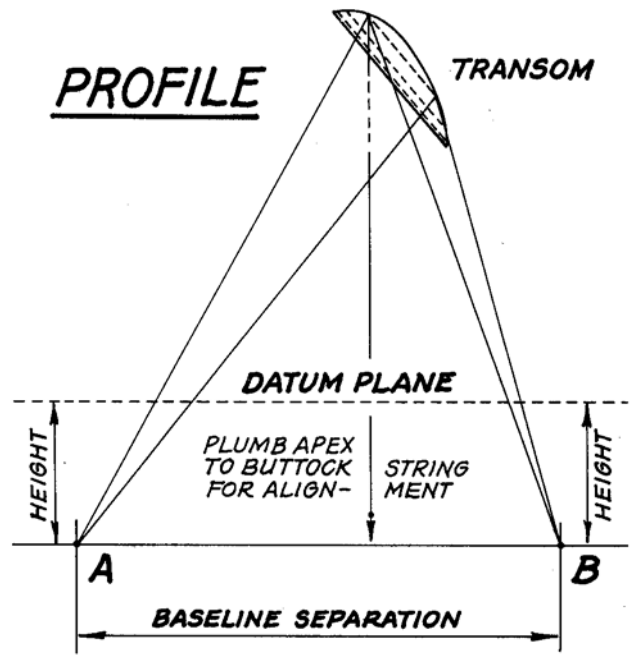

Fig. 4.3.26
Triangulating a Transom

a datum plane. If obstructions make a layout like Fig. 4.3.26 impossible, each buttock section plane could be measured with a set of triangles different from every other plane. You will have to measure the fore-and-aft position of each triangulation point on each buttock line as well as their elevations in order to plot the transom points later.

The apex of each triangle at the transom edges must be established athwartships by using a plumb line from the transom edge to the buttock lines. If a plumb line cannot be used, you will have to establish the centerline of the transom, and lay out the buttock lines by measuring to each side from it. If the transom is curved (whether along a vertical or inclined axis), a slight error (+0, -1/2") will be introduced in the athwartship positions of the outermost planes. Laying out the apexes with a tape in this manner will be necessary if the vessel is listed to one side.

At the drawing board, once the triangulation points are laid out in profile, the transom edges can be found by swinging arcs from the points with a compass adjusted to the scale lengths of the recorded triangulations. If the field work was accurately performed, the plot of your compass arc intersections should yield the profile projection of the transom as well as the buttock plane locations.

4) Digital Transit and Electronic Distance Measurement (EDM). This "Black Box" or high-tech process, has great data-gathering potential and flexibility. A digital transit (or theodolite) measures angles electronically and gives a readout in digits instead of requiring the operator to interpolate a vernier scale. This can save time and reduce errors considerably, especially if you are not accustomed to using vernier scales. An EDM unit measures distances by timing how long it takes a series of low-power laser pulses sent from the unit to

return from a reflector set up at the point whose distance is sought. The EDM unit is a separate piece of equipment for many older transit models, since such equipment is usually designed for long-range land surveys. More modern transits incorporate the EDM function in the telescope; such units are known as "total stations". For the relatively short-range distances encountered at a vessel, it is preferable to use a total station. This way, you can avoid the calculations for triangulation errors introduced by an EDM with a line-of-sight different from the transit scope. The EDM and transit functions are interconnected so that distance and angle measurements can be converted by an onboard computer into coordinates or into distance measurements projected into horizontal or vertical planes. Some units provide both a digital file for computer display and a hard copy printout of coordinates. Hard copy printouts should be obtained for all data and stored with project field notes.



An EDM Device or "Total Station"

In principle, a total station could be set up near a vessel, an arbitrary coordinate system keyed into the system, and measurements made from the vessel by merely spotting a prism on the hull in numerous section planes. A station point from which an entire half of the hull is visible would have to be chosen, unless there are two or three benchmarks that can be used to coordinate several station points. Most total stations store the coordinates of each point in terms of cartesian coordinates or range with horizontal and vertical angles. If downloaded into a computer or plotter, lines could be generated directly from the field data. Some sophisticated programs can plot compound surfaces from a series of points, which could potentially eliminate the need to set up precise section planes in the field. Instead, section planes could be chosen at will at the computer, and derived from the machine's internal three-dimensional plot of the hull surface. However, this involves expensive equipment and trained personnel. It is also difficult to check the accuracy or suitability of your data in the field, since most such computers and plotters must be located in an office. It may be easier and less expensive in terms of time and money to simply set your instrument up at each station, adjust it to a true section plane, then record the section line with range and bearing coordinates. The EDM eliminates climbing on ladders, and the electronic readouts reduce errors from misread tapes and vernier scales. The readouts could be retained in the instrument's memory, printed out, or recorded by hand and plotted in the field as a rough check to see if you have set the system up properly. A word of caution, though: the EDM device really measures to the position of the prism or reflector, not the actual hull surface, so the sizes of these things introduces an error factor which must be taken into consideration when drawing the lines. Some reflector materials are now available that are fairly thin.

5) Laser Scanning or High Definition Survey Technology. Another form of EDM surveying is generally referred to as "laser scanning." Lydar scanners send automatic pulses at high speeds to and from an object to capture millions of point coordinates in a short time rather than one point at a time like the "total station." Laser scanners are highly accurate and produce a 3-dimensional point cloud that can have the appearance of a pixilated photograph. This point cloud can be rotated to show any view and measurements can be taken from any point to another. Software packages allow a delineator to "connect-the-dots" to create drawings or to apply surfaces to render a solid computer model.



Fig. 4.3.26b
A laser scanner using Lydar technology and the "point cloud" generated by it.

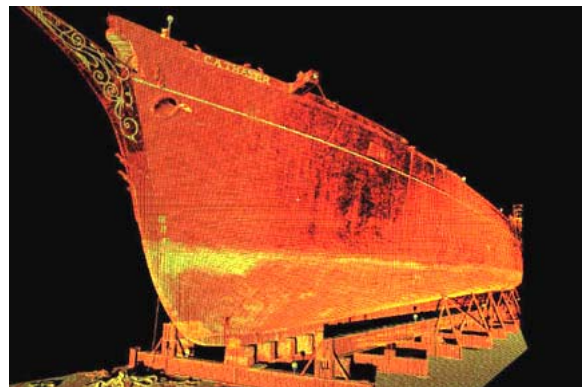

There are a variety of hardware and software solutions available using this technology, but they can be costly to purchase. There are numerous service providers that can be contracted to scan a vessel and provide a range of products from computer models, animations, line drawings, even highly accurate scale models digitally cast from the computer files.

6) Stereo-photogrammetry. This is in many respects the ideal recording process, since it is speedy, and far more comprehensive and exacting in its coverage of a hull than any other method discussed so far. In addition to providing information for plotting lines, the photographic images used by the method also provide a detailed photographic survey of a hull's condition and exterior construction features. In principle, two photographs (a "stereopair") are taken of the side of a hull, each from a pair of cameras set at known, recorded distances from the hull and from each other. After development, the images are placed in a plotting machine whose operator sees them combined as a three-dimensional image or "model." The plotter contains a pointer which can be controlled to measure the model as seen by the operator, causing the machine to draw the contours on a plotting board. Advanced, computer-controlled analytical plotters can be adjusted for many kinds of error in camera position, focal length, mismatched image size, and so forth. Buttocks, water lines, and sections can all be plotted from stereopairs. In practice, however, field work to place and adjust the cameras must be fairly precise, and targets need to be set on the subject at known intervals to provide scale. Often many stereopairs must be taken to complete a survey that will yield an adequate and accurate plot of the lines. Keel blocks and shoring can also interfere with a complete view of a hull, and the confines of a dry dock may result in taking many more stereopairs than necessary due to the unavoidable closeness of the cameras to the vessel. A problem with stereo-photogrammetry

is that most stereopairs are glass plates whose size is less than 4"x5" specified by Standard III.

Combinations of computers and metric cameras have appeared which allow one to use a single camera (not a stereo camera) and images taken from a dozen different vantage points. (Metric cameras are available with a 4"x5" format meeting Standard III.) The camera does not need to be set up or located with a transit. By digitizing a number of the same points or coordinates in each photograph, the computer program calculates the camera locations and lens axis angles for each image. From this point, the operator only needs to digitize a single point in three different views for the computer to plot its location in three dimensional space. Skill in accurate digitization is vital to the accuracy of the plotted results. Time that would otherwise have been required in the field to measure a vessel by hand can be consumed in the office plotting points, but access to the vessel itself is less necessary. Use of photogrammetry assumes that there are sufficient distinct points on a hull (existing, as in planking seams) or applied points (targets) to plot!

It should be noted that photogrammetric systems can only "measure" what their cameras can "see". Line of sight is critical. Features hidden to cameras must be covered by other photos or by hand-measurement. Photogrammetry probably will not lend itself well to the cramped interiors of most ships.

Major drawbacks to the use of photogrammetric equipment, however, are the very high cost to rent or purchase it and the extensive technical expertise required to operate it. Those who know how to use such equipment need no further introduction to the process, however, photogrammetrists who have not recorded a vessel should read these guidelines carefully in order to achieve proper results from their work. See Section 4.8 (References and Resources), for readings in photogrammetry.

MEASURING STRUCTURE for CONSTRUCTION DRAWINGS

Construction drawings, because of their detail, are in many ways more complex to produce than lines drawings. Because of this, many of the remarks to follow are general in nature and cannot possibly anticipate all special cases or warn of every pitfall. It is hoped that you will be able to infer many of these things after reading this section and spending a few hours in the field. Review team guidance and reading through case studies applicable to your project will also help you to be better prepared for your field work. The remarks to follow assume hand methods will be used rather than “Black Box” methods or photogrammetry. (Interior sections and plans are extremely cumbersome to produce photogrammetrically, since cameras cannot see through bulkheads and decks.)

In some respects, the field work and notes for producing construction drawings are similar to recording a building for HAER. As you will quickly discover aboard your vessel, however, nothing seems to be straight, square, level, or plumb! Some elements of your vessel may seem to fall easily into a square framework, *but you are better off assuming nothing does, and performing all your fieldwork from this point of view.* This then becomes a very interesting challenge, a test of your ability to imagine objects in three dimensions. Vessels almost sit there and dare you to accurately capture their elusive curves and subtle shapes.

The Golden Key to gathering useful data is to *triangulate the locations of all features in plan and section* from major features or established benchmarks as needed for your final drawings. *There are no shortcuts.* Failure to follow this will mean a return to the ship to obtain

measurements to locate otherwise unlocatable or mislocated features. Team members should actively check each others’ work and assumptions as measurements are taken, so critical data are not overlooked or improperly taken.

Simplicity First. Be prepared to find that plans, sections, and profiles are much more intricately interconnected for drawing a ship than for a building. It is best to begin with general overall sketches and measurements, covering ship structure, deck plans, inboard profile (longitudinal section at the vessel’s centerline), outboard profile (exterior elevation), and various end views and sections. Details of masts and rigging, joinery, and machinery should be pursued later. Without the plans and profiles, the locations of these latter items will be impossible to plot, anyway. Don’t get distracted into sketching and measuring small deck features and other details on overall views. Details should be covered in separate field notes where they can be drawn at a much larger size. The time lost deciphering notes made illegible by tons of crowded details is better spent making clearer notes on separate sheets, especially in the eyes of a future researcher--or your team member at the next board, who will pester you with questions every time he can’t figure out your overly cramped notes. Paper is cheap compared to the costs of false economy in frustration and lost effort. See Section 4.4 on Field Notes.

Vessel’s Scantlings and Structure. The first feature to record is a vessel’s internal structure. You must obtain cross-sectional dimensions, or “scantlings,” of the deck beams, deck planking, frames, keel, keelsons, clamps, stringers, hull planking or shell thickness, fasteners, etc., and record their materials. Such data can be recorded in separate tables, or in tables or notes labeled on sketches (sections, plans, etc.). Thorough scantlings checklists for both wooden and metal vessels appear in Section 4.4 (Field Notes). In general, scantlings may best be recorded in a table, and sketches used to show overall configurations and interrelationships of parts;

important dimensions and major notes can be added to these. Inaccessible structure for which data are speculative, unrecorded, or derived from other sources must be noted as such.

Hull Sections. Hull sections should be sketched on which structural configuration and dimensions between major structural members and assemblies can be shown. A midship section is a necessity. Details of mast steps, stanchions, engine mounts, transverse bulkheads, joints, splices, etc., should also be sketched, but on separate sheets. Separate enlarged sections of built-up wooden or metal members may be needed if simple verbal descriptions (such as 2"x3"x1/2" angle) do not suffice. It may prove convenient later to draw and measure these sections at lines-lifting stations in order to more easily relate shape and structure at the drawing board.

Plans. A structural plan for each deck is in order, on which you should sketch all deck beams and record the longitudinal placement of all accessible beams with running measurements. (Inaccessible ones should be positively noted as such, not just left blank.) Mast partners, carlins, clamps, lodging knees, margin plates, longitudinal and diagonal ties (in metal vessels), and other structural members should appear. You might also include frame ends and deck stanchions at the main deck. If you can establish that frames were erected at fairly consistent intervals (such as 2'-0" ∇ 1/2"), you may save time by measuring only to every 10th frame or so, and drawing the frames between at 2'-0" intervals at the drawing board (with a note explaining how much they vary in actuality). Check with your review team and team historians to see if variations in spacing are significant enough to warrant closer attention. Cross sectional dimensions of some beams may need to be included on the sketch, along with notes of any repairs, replacements, types of materials, or irregular and unusual features. (How to identify some materials and old and new work will be discussed shortly.) Keep your camera handy to photograph *both* typical and unusual conditions. A table of scantlings

specific to the view in the sketch might be put on the drawing for convenience at the drawing board. To keep the notes legible, it may be necessary to do a plan several times (you can photocopy it), and separate running measurements of beams from frame locations, etc. Details of joinery, fastener patterns (treenails, drifts, bolts, rivets), and other structural details should be separate sheets, again in order to avoid overlapping too much information.

Once internal structure has been documented, you should move on to profiles, plans, and sections on which to record dimensions to finished surfaces (e.g., compartment bulkheads in crew's quarters) and major components (e.g., engines, capstans). Masts and rigging are discussed beginning at page 4.3.43.

Types of Sketches and Measurements. In a sense, you will be taking two series of measurements: one directly off the features you are recording, and the other as projected into plan or section planes (see Fig. 4.3.27). These may require different sketches for the same feature in order to keep information clearly organized. Keep in mind that the views you will ultimately draw in finished drawings are *projections*: cambered decks, skewed partitions, tilted rails and other angled features cannot appear "edge-on" or in direct elevation or plane as flat floors and walls might in buildings. A lot of your measurements should be taken in planes parallel to those used in your final drawings (water lines, buttocks, and sections), just to simplify work at the drawing board. Check to see if features aboard your vessel--such as deck plank seams, partitions, deck beams, etc.--fall in or near such planes. If so, you can use them to line up dimensions and triangulations. A good feel for geometry and trigonometry will be invaluable in judging what dimensions to take, and where, thus simplifying your work while maintaining accuracy. Imagining how features will look in your final drawing will help you check your judgments. By all means make notes on your field sketches to indicate which dimensions are direct and which are projected,

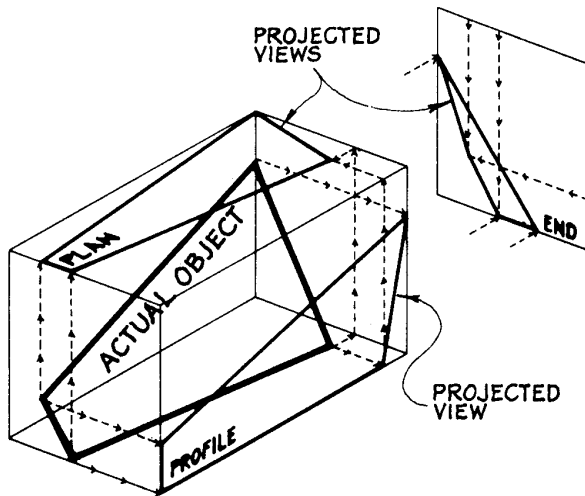

Fig. 4.3.27

Projected vs. Actual Dimensions

or use different colors for the different types of measurements. Most direct measurements will be foreshortened when you plot them in projection at the drawing board (see Figs. 4.2.27 and 4.5.44).

Checklist. It is wise to develop a checklist at the beginning of a project and keep it handy to guide you in covering the numerous details for which you are responsible. When you think of something additional that bears noting, stop and add it to the list for future action before you forget it.

Field Photography. Field photographs can be of great help here, but bear in mind that they record a perspective, not projected, view of a subject. See Section 4.5. It may occur to some recorders that enlarged photographic prints of features could be used as field notes by drawing dimensions directly onto them. However, the time lost while useful views are selected, photographed, and processed probably makes this method economical only for the most complex subjects or small details whose execution can be left till later in a project.

Old and New Work. Be on the lookout for clues to modifications and repairs. There are many ways to identify them. Some are obvious, like unusually short pieces of wood let into decks or bulkheads. Others include: changes in condition of materials may be indicative--solid clear wood or smooth metal surfaces adjacent to partially weathered, corroded, or worn materials; changes in wood species--a pine deck beam amidst oak ones; changes in the quality of workmanship, such as crudely cut holes or joints, poorly formed rivets, or replacement of elaborate moldings and carvings with simpler ones; features that don't line up when they probably would have if built at the same time. Also look for welded instead of rivetted work in metal vessels built primarily by rivetting, or rivets different from those used in similar work elsewhere in the vessel. Rolled structural shapes (Z-bars, channels, etc.) installed where built-up shapes are predominant very likely indicate later work, as might changes in manufacturer's names rolled into such shapes. Patterns of corrosion with noticeable edges or boundaries may indicate that something was removed, as may ridges in paint finishes, or changes in the number and colors of paint layers from one area to another on a continuous feature. Look for outlines or joints showing through finishes; changes in fastenings or fastening materials, screws used instead of bolts or nails for similar features, etc. Interpreting these things adequately may depend greatly upon the availability of reliable historical data, such as old drawings, records, photographs, or recollections by owners. Your project's review team may be of considerable help in evaluating these things also.

Deck Plans. The main deck is most likely a compound curve. It not only curves vertically ("sheer")--higher at the ends than the middle--it also curves horizontally--higher at the centerline than at the sides. The curvature athwartships ("camber") is intended to shed water, since the main deck must also act as a roof for the spaces

below. The deck structure is also a major structural member: it keeps the sides of the vessel from collapsing inward and provides longitudinal strength, just like the top flange of an I-beam. Lower decks may not have a camber to them, but they more than likely will have a sheer.

General Approach. Overall recording of deck plans should be done *at the deck surface*. Do not attempt to cover things above, such as roof lines of deckhouses, since these very likely may not lie directly above connected features at the deck in strict plan projection. Rely on notes taken for the inboard profile and the sections to locate these things in plan at the drawing board. Treat each deck as if it were flat, and take measurements fore-and-aft, and athwartships. The error introduced by the deck camber is negligible where the camber-to-beam ratio is around 1:50 or less. (For example, a camber of 6" in a deck 25'-0" wide would give a taped reading of 25'-0 5/16".) Again, running measurements are preferred to additive measurements, because errors are not cumulative--an error in one measurement will not throw off all succeeding ones. Take advantage of symmetry, but double-check it occasionally against a grid line or reference line.

Laying Out and Using a Grid. For recording the curves at the edges of the deck, locations of lugs, ventilators, masts, deckhouses, and other features on deck, few things are better than a grid (see Fig. 4.3.28). Swing offsets can be made from features to grid lines, or triangulations made from the grid line intersections (see Fig. 4.3.29). This system is also independent of level or plumb lines, though it can be used with them aboard stationary vessels; grids have been used successfully by HAER aboard floating vessels where there is no constant level or plumb to refer to. A grid system can be laid out on deck using chalklines, tacks (copper, not steel), and measuring tapes. You might assume for starters that deck plank seams at the deck centerline run

true fore-and-aft, but don't leave this unverified. Begin by measuring and halving the beam of the vessel in at least two places where the deck is clear from one bulwark to the other (more places will be necessary on a large vessel, or on one where the deck has a pronounced sheer). Use the bungs in the deck planks to line the tape up squarely athwartships (assuming for starters that the bungs lie in an approximate line and that deck beams beneath lie square to the ship's centerline). Once you have the two centerline points, set up points port and starboard equidistant from the centerline points. These four points should be outboard enough that a string stretched through the two port or starboard points will clear most or all deckhouses and other obstructions. These lines should lie parallel to the ship's centerline, and should be marked on the deck with a chalkline. Next, set a line athwartships, square to the last lines, using a 3:4:5 triangle set with tapes. (If it seems likely that the deck camber may distort this triangle, lay two of them out, back to back with the base lines touching, and split the difference between them, if any.) It may be worthwhile to set this line at a row of bungs (over deck beam), frame, or lines-lifting station depending on the program for your project. From this line, tacks can be measured and set fore and aft along the two earlier parallel lines, and chalklines snapped athwartships between these tacks, being careful that the deck camber doesn't skew the chalkline. Try to set tacks at integer multiples of feet for simplicity's sake, and record the entire grid system, with dimensions, for later reference. Extra offset lines from the centerline or athwartships lines can be set to avoid obstructions or for special circumstances. Each tack should be given a reference name which need be no more than an alphanumeric code like "2P" for second station, port side.

The grid system should be drawn to scale after it is laid out in order to verify its suitability. If mylar drawing sheets are used for preliminary plots, the grid system can be plotted on the backs of the sheets, and plotting work done on the fronts. This way, errors can be erased

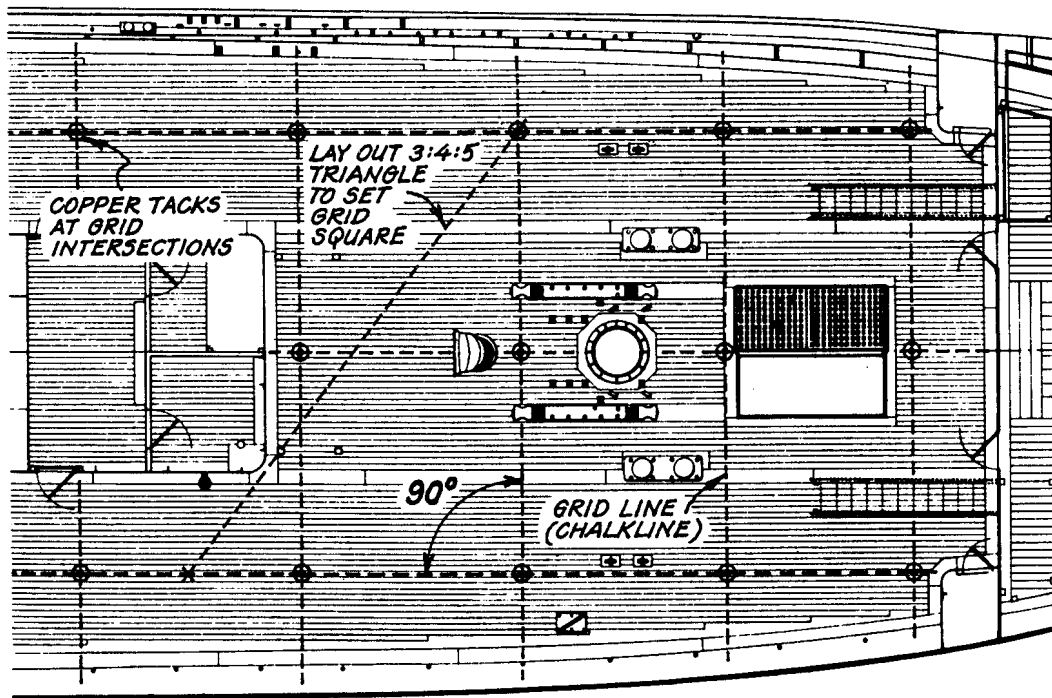

Fig. 4.3.28

Laying out a Grid System on Deck

without damage to the underlying reference system. You may choose to plot the grid system on one sheet, and do all plotting work on separate sheets laid over the grid plot. This way several layers of information can be generated and verified for later combination into final drawings.

Diagonals and Triangulations. Diagonals and triangulations among features and grid tacks should be taken on deck, but they should be treated with caution over long distances, because they may not necessarily be used directly in drawing a plan. On a compound surface, such measurements are actually made along skewed lines, which do not project easily into any orthogonal plane. The error introduced by the curve for short distances and a slight camber or sheer is in most cases negligible, but as the deck curve becomes more extreme or the distances longer, the error can grow to several inches on a large vessel. In long measurements, taped measurements made on deck should be

supplemented with ones made with the tape lying in a horizontal plane with respect to the deck, just as a check. It may be difficult to do more than approximate level if you are working aboard a floating vessel. The minimum dimension you read from directly above (plumb) to a point is the true dimension.

Arbitrary Triangulation Points. Instead of relying solely on physical features or lines stations as benchmarks, you may find it useful to establish arbitrary triangulation points on a deck for coordinating or double-checking other measurements and triangulations (see Fig. 4.3.30). Such points can be very useful where the layout of physical features produces a lot of triangles with very acute angles. Slight errors in the legs of acute triangles tend to magnify the error in the placement of points. If you set an extra point in middle of such an area and triangulate to it (as well as other features), the interior angles of the measurement triangles can be made much less acute, and they can then be

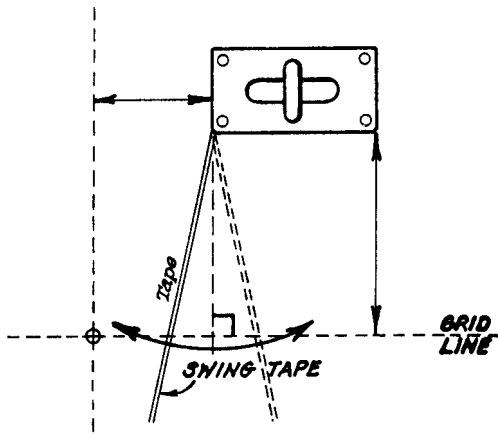

Fig. 4.3.29
Offsets from Grid Lines

much more accurately plotted at the drawing board.

Beam Measurements. At the main deck, the beam of the vessel (port sheer to starboard sheer) should be taken at every lines-lifting station or section. (Similar overall widths should be taken on other decks as well, but not necessarily at the lines-lifting section planes.) You should try to measure the beam both with the tape lying along the camber of the deck and with the tape taught (in a straight line), and note what the difference is, especially if it is appreciable enough to affect scaled dimensions at the drawing board. If the bulwarks interfere, measure to the inboard surfaces of them, and add their thickness and any outboard dimensions for a total. If deckhouses or other obstructions interfere, you can either measure them separately (as additive dimensions), or take the beam before and behind such features.

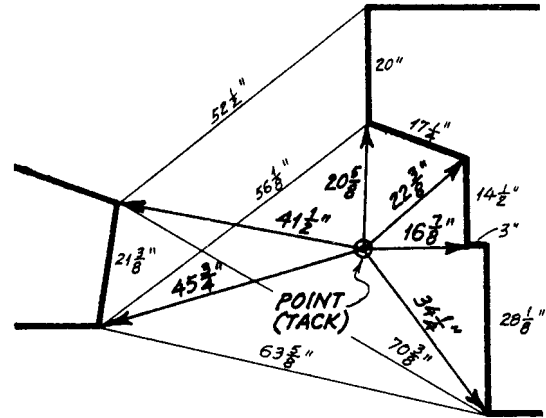

Fig. 4.3.30
Using Arbitrary Triangulation Points

Deck Camber. This may be as good a time as any to take the deck camber of the main deck at each station (see Fig. 4.3.31). This may be done by stretching a string or wire across the deck equidistant above the sheer at the sides (or at points symmetrical about the deck centerline) and measuring the change in deck height at recorded intervals. This may also be done from below deck. Such data will be essential for the inboard profile and sections. Cambers can also be done with a transit, using a procedure to be covered later. You may find it worthwhile to take and plot the camber at three widely spaced stations. If the curve (not necessarily the depth) remains the same, it is likely the beams were all cut from a single pattern, and no more cambers need be taken unless distortion or other special conditions are present. On some vessels, however, the curve in the deck beam camber may be different for each beam. Recording deck elevations will resolve any questions.

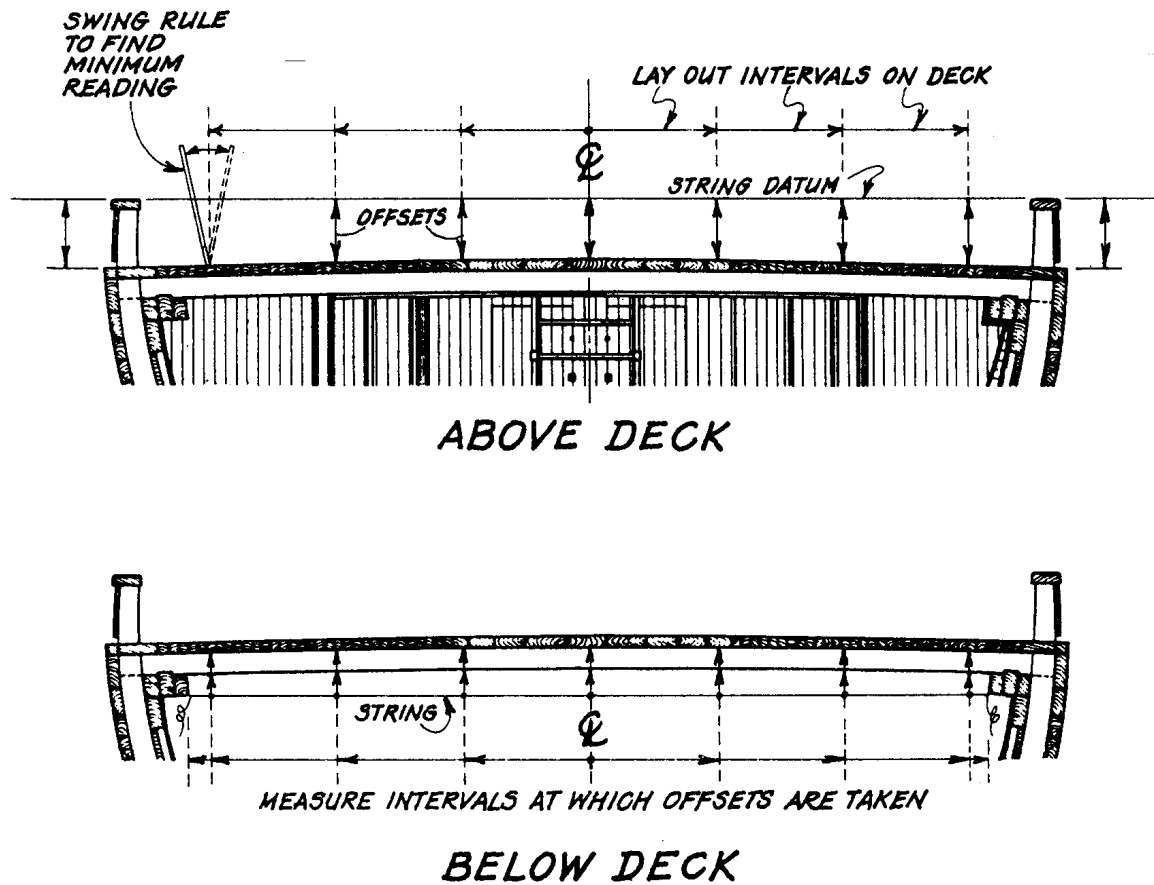

Fig. 4.3.31
Measuring Deck Camber

Features Curved in Plan. Some deckhouse sides or bulkheads may curve in plan. To record these, you can either record the curve as a series of offsets from the vessel centerline (or from a line parallel to it), or as offsets from some other line whose endpoints are established by other features (see Fig. 4.3.32).

Profiles and Sections. Success in drawing profiles and sections up later will depend very heavily on having accurate deck plans and on having accurate measurements of the sheers (from the lines-lifting), deck cambers, and breadths. Recording the relative heights of all features is also essential to pegging their vertical locations in any profile or sectional drawing--the

use of a water level or transit is invaluable for these purposes. Relative horizontal positions are also required so that features can be correctly positioned horizontally in the drawings. Here plumb lines or vertical-plane triangulations to features above (or below) deck surfaces must be used.

Hull or Shell Expansions. A hull or shell expansion amounts to a map of a hull's surface akin to a Mercator map of the earth. Just as a Mercator map flattens the curved surface of the globe onto a rectilinear coordinate system, a shell expansion flattens out the surface of a vessel's hull, usually to show surface features such as planking patterns, plate joints, fastener

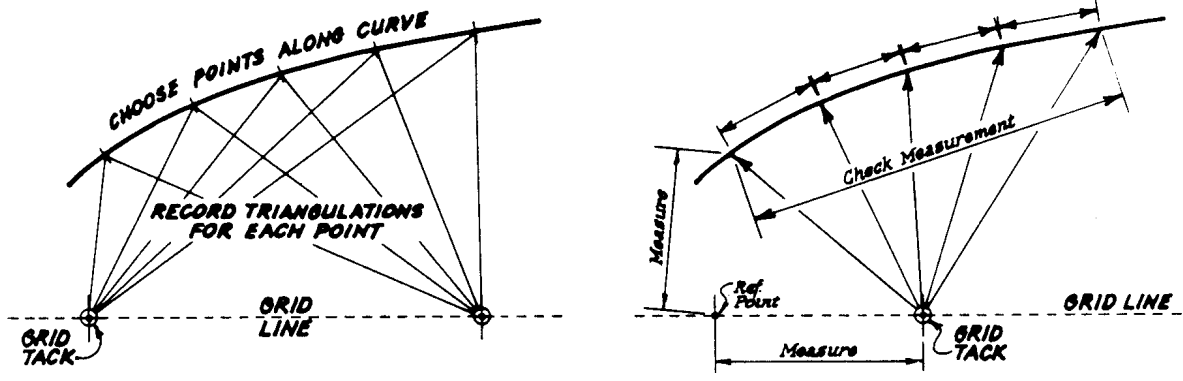
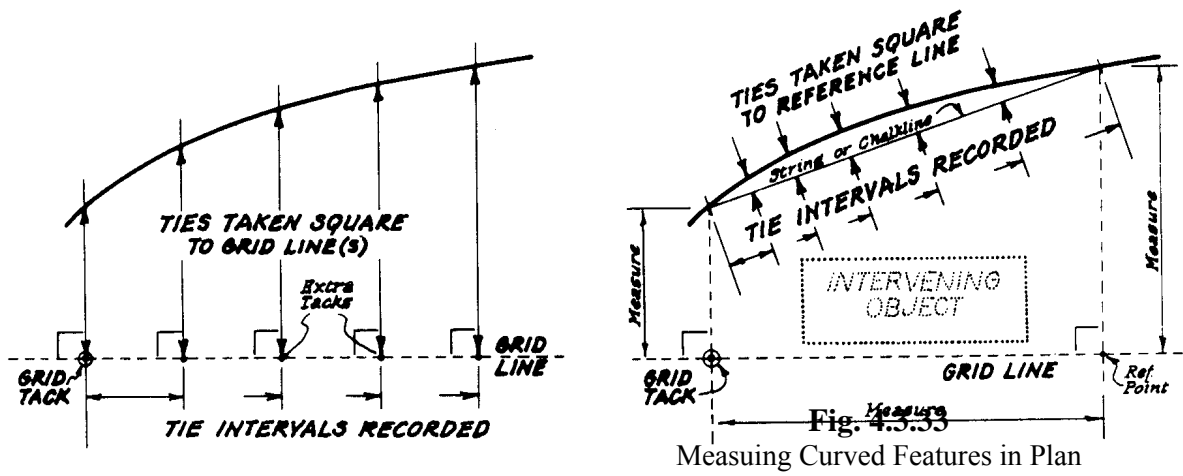

patterns, or other features. It is developed by taking measurements from the rabbet or sheer lines to planks and other hull features *along the hull surface* where section planes intersect the hull. These measurements are then laid out from a centerline (rabbet or keel) along corresponding section lines in a drawing, and points for planks, etc., are then faired in (see Fig. 4.3.33). This type

of drawing sees a lot of use in hull surveys or repairs. Such drawings are not usually required for HAER work, however, and because of the time they consume, they are discouraged unless the features in your vessel's hull surface are of such a significance that they cannot be adequately documented in any other way.

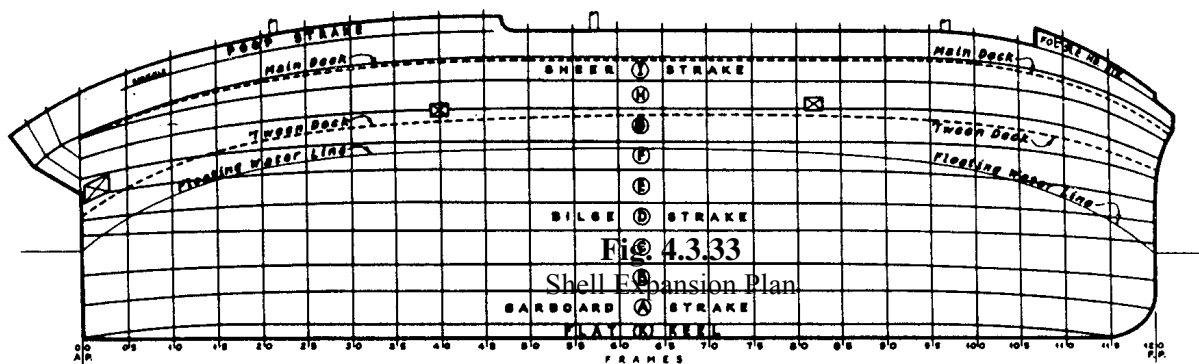

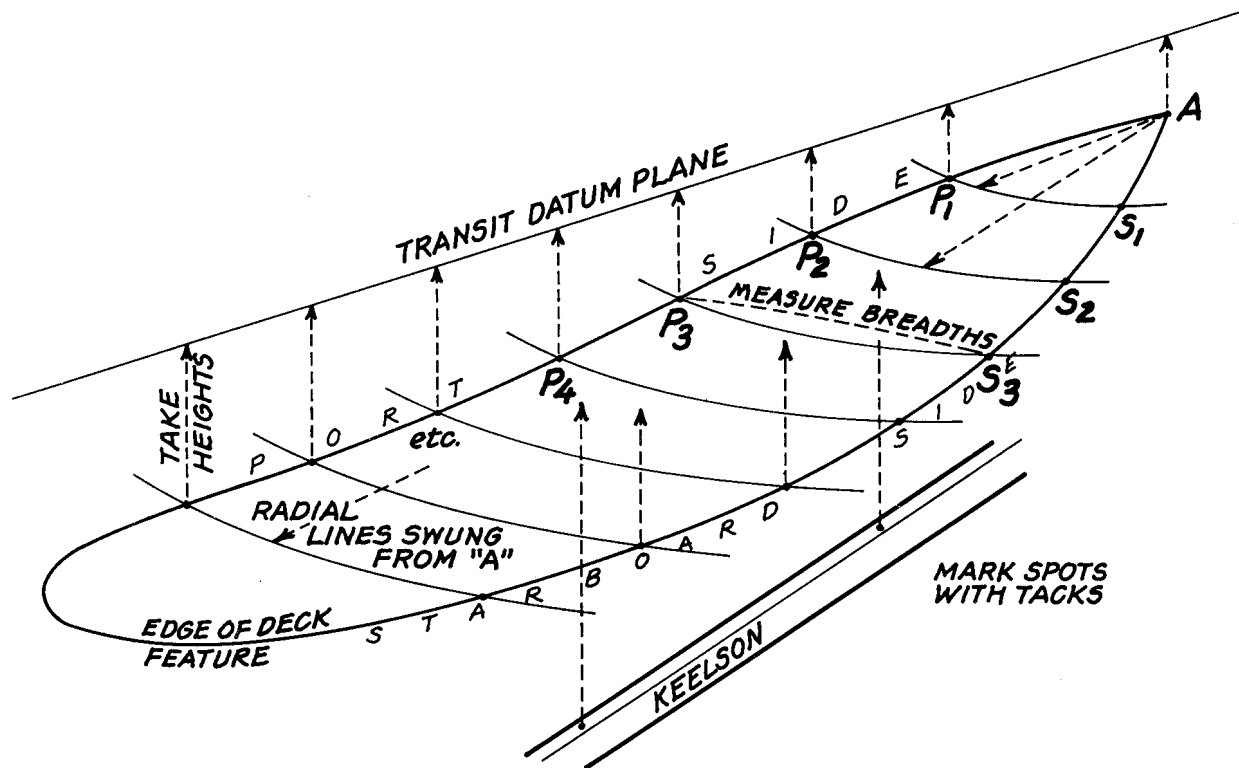

Fig. 4.3.34

Layout of Radius and Beam Method

(longitudinal reference string and placement of transit plan for elevations also shown)

Radius and Beam Method for Recording Deck Plans. This procedure works best for vessels less than 100 feet in length with few deckhouses. To begin, a copper or bronze nail is set securely in the centerline of the stem (or you can begin at the stern or transom centerline). Pull a tape from this nail, labeled A, to points port and starboard along the inboard edge of the vessel's covering board (see Fig. 4.3.34). You may also set marks at the centerlines (or edges) of cap rails and other features that the tape can reach along the vessel edges. The fact that the tape is more inclined for some points than others is of no consequence; calculations will take this into account. Make each pair of points (P_1 for Port 1, S_1 for Starboard 1, P_2 and S_2 , etc.) equidistant from A (that is $AP_1=AS_1$, etc.) and use integer foot dimensions for simplicity. Make

a diagram of the deck and *record all distances from A* in a table, allowing extra columns for some future calculations needed to plot each point. (See the field note illustrated in Fig. 4.4.1 for an example of such a diagram.) Be sure you set pairs of P and S tacks so that a tape pulled athwartships between them is not blocked by a deckhouse or other feature.

Once the P and S tacks have been laid out and their radial distances from A recorded, you need to establish some bow-to-stern reference line from which the athwartships positions of the tacks can be measured. Otherwise each A-P-S triangle has only point A in common, and no other measured interrelationship established. You could assume each A-P-S triangle was symmetric about the ship's centerline, but in

reality, such assumptions become your undoing. The actual centerline of a vessel on deck is usually blocked by masts, deckhouses and the like, so a different reference line must be established. This can be done in several ways: (1) Pull a string from tack A to a point on the transom, so the string clears all deck features. Then, when you measure and record the distances between each pair of P and S points, you can also pick up the position of the reference line where the tape crosses it. (You may have to use a plumb bob or torpedo level to transfer the reference string location to the tape--this becomes less accurate as distance increases between the reference string and the P and S tape, especially on a floating vessel.) The reference string does not have to begin at A, though this is a most convenient point for plotting. It can be located at any place and at any angle to the deck centerline (in plan), just so long as it is a continuous straight line. After plotting, this field reference line “disappears”. (2) A transit could be used to set such a reference line and read the tapes pulled athwartships after the instrument has been set up to record deck point elevations (more beginning on page 4.3.45).

Once you have recorded the A-P-S triangles, you must set up a transit datum plane amidships, following instructions on pages 4.3.45-48, and record the depths of all tacks beneath the transit datum plane (be *certain* not to forget A!). Before you begin recording elevations, make a field note for recording the centers of forward and aft edges and all corners of all deckhouses, companionways, skylights, etc. (As long as the instrument is set up, you will save time by obtaining the elevations of these features also, and you will have a more accurate job.) If you must record a plan below the main deck later, be sure to set at least two tacks below decks at spots beneath deck openings through which you can pull a tape from the tacks up to this main transit plane. This will be essential to setting a datum plane below decks which is parallel to the main plane (see Fig. 4.3.34).

Once deck elevations have been taken, you can unlock the vertical circle of the transit and use the instrument to establish and record a longitudinal reference or “centerline” if a string is too cumbersome or inaccurate for the purpose. Center the telescope on tack A and lock the horizontal circle. If A is not visible, simply lock the horizontal circle of the instrument in a position where the telescope is roughly parallel to the vessel’s centerline (exact parallelism is unnecessary). When you pull a tape between a pair of P and S tacks to record a breadth, you can simply rotate the telescope vertically until the crosshairs intersect the tape, then read the tape at the crosshairs and record the dimension. The vertical circle of the telescope describes a plane that is square to the datum plane, so no distortions are introduced by parallax while reading a tape beneath a reference string. Use of a transit for this procedure is highly recommended aboard floating vessels since both the transit datum plane and the vertical circle plane *move with the ship*, unlike plumb bobs and torpedo levels where even short-range use may be too inaccurate on a shifting deck. When you begin measuring P and S tacks astern of the transit, merely “plunge” the scope (rotate it through vertical position) and continue reading the tape as you go astern. There is no need to unlock the instrument’s horizontal circle and try to turn it 180 degrees; not only does this take time, you might set the scope at the wrong point.

Reducing Field Measurements for Drawings.

This is where the dimension table discussed earlier comes in handy. The radial measurements set out on your vessel with tapes from point A *cannot* simply be laid out with a compass on a drawing sheet. If you do so, your plan will be artificially long (incorrect dimensionally), and the steeper the tape from level (your deck plan plane), the greater the distortion. Instead, you must calculate where each point will project into your deck plan. To do so, you *must* perform the

following calculations *for each point* using the elevation of each point and its distance from A to calculate d (see Fig. 4.3.35):

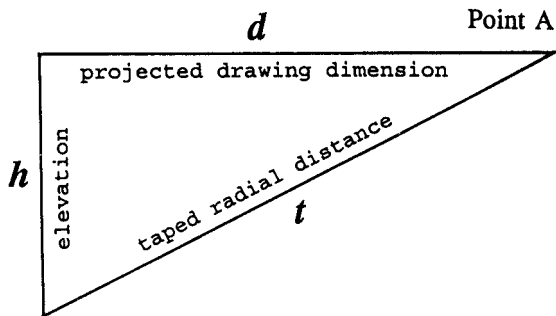

Fig. 4.3.35

$$\theta = \sin^{-1} \times \frac{h}{t}$$

then:

$$d = \frac{h}{\tan \theta}$$

If trigonometry intimidates you, you can resort to the Pythagorean Theorem:

$$d = \sqrt{t^2 - h^2}$$

Whichever procedure you choose, convert *all* your dimensions to decimal inches (e.g. 54 3/4" = 54.75" and 3'-7 1/2" = 43.5") or to decimal feet (e.g. 54 3/4' = 4.564' and 3'-7 1/2" = 3.625'). Do not mix the two, or your results will be erroneous. A table will allow you to keep all conversions and operations in a systematic order and reduce mistakes.

Vertical Reference Planes for Heights

Advantages of the Transit. Transits may be used aboard stationary vessels, with or without water levels. Aboard floating vessels, however, water levels are useless since true gravity level is always changing with respect to the ship. In these cases a transit is *essential* for providing horizontal reference planes on every deck from

which the vertical positions of features in profile or section can be measured. Like the water level, this instrument does nothing to locate features horizontally above each other. Since all you will be doing with a transit is measuring elevations from a reference plane, there is no need for an electronic transit--a mechanical instrument with vernier scales ("Category 1") is less trouble to set up and use. (It may be wise to coat scales, threads, and other exposed metal parts with Vaseline or other preservative to protect them from corrosion by salt.) Obtaining the relative heights of numerous features to reference planes can be of considerable help in tying together a profile or section, especially over the length of the vessel. Spot elevations can be used to double-check not only your triangulation work in locating deck features vertically, but also the vertical coordinates of sheer and deck centerline curves. Making spot elevations is fairly easy. Because the shortest distance from a point to a plane is always a line normal (i.e., perpendicular) to the plane, you can readily determine the distance from a vessel feature to the reference plane by setting a stick rule on the point to be measured, and moving the rule top around while the transit operator records the *lowest* reading seen at the scope crosshairs. No devices of any kind are necessary to try to square the rule to the transit plane (see Fig. 4.3.39).

The Water Level. For use only aboard *stationary* vessels, this tool relies on the principle that water always seeks its own level (see Fig. 4.3.36). This "low-tech" but extremely effective tool consists simply of a hose (any convenient length) filled with colored water and having two transparent tubes fixed at either end, left open to the atmosphere. (Corks or stop-cocks can be used at either end to keep the water from running out when the level is being moved or stored.) Using this level, you can "transfer" a reference plane from a single reference point anywhere around the vessel,

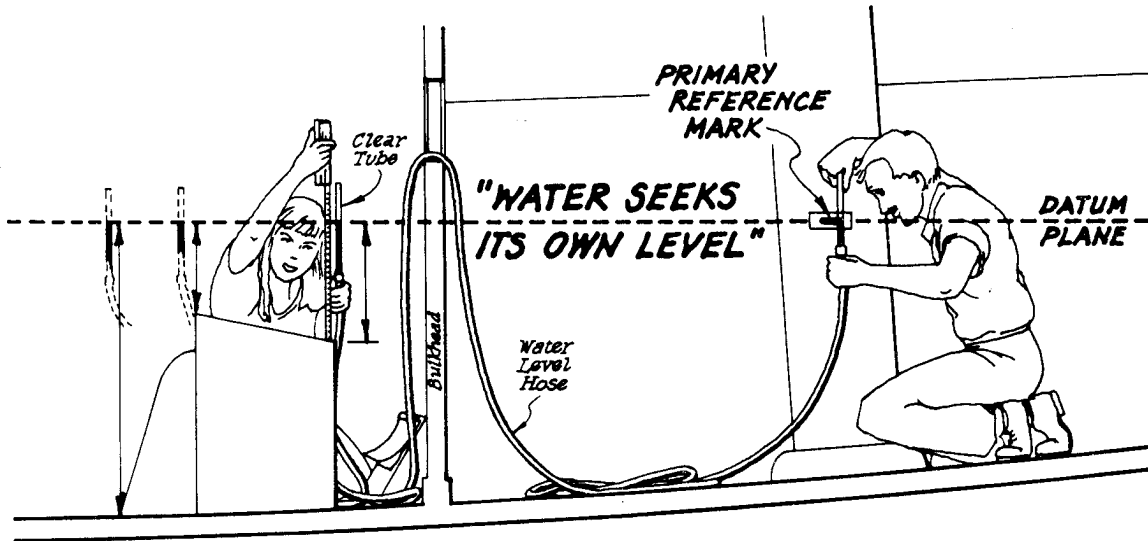

Fig. 4.3.36
Using a Water Level

even around multiple corners where transit sightlines cannot conveniently go. Its use can take some time over long distances--you must wait for the water level oscillations to settle down, then adjust the height of the free end until the water level at the fixed end matches the reference mark. This tool does nothing to locate features horizontally above each other--for this, a plumb line or vertical-plane triangulations must be used.

Using Reference Planes. The locations of these reference planes are in a sense arbitrary, since all they provide are relative dimensions. However, you will make life a lot easier for yourself if you attempt to establish these planes level athwartships with respect to the vessel's sheer lines (never mind the true horizon), and level fore and aft with respect to the vessel's floating water line. These planes will then closely parallel the ones you will work in at the drawing board or CAD station. Depending on the size and complexity of your vessel, you may have to set up more than one transit station per deck in order to capture all the references you need. If you must set up several planes, it is wise to try

to keep them all parallel to each other for ease in laying out your measured drawings. Maintaining parallelism can be done a number of ways, but one of the easiest methods is to mark at least three places on the vessel where the first plane intersects vessel features. In some situations it may be better to set marks on tall stanchions which have been erected on board and firmly fastened to the ship for the project's duration. A minimum of three points is necessary (the more widely spaced the better), because it takes at least three points to lock in the orientation of a plane; two points will allow a plane to pivot on the line connecting the two points. Four or more points (and stanchions) are advisable for the initial plane, positioned so you can always see at least three points from any location on deck. If you intend to use a transit on other decks, make readings through deck openings to at least three features on each of the other decks (or set at least three marks in each deck space, equidistant from the first reference plane) while your first station is set up. Then whenever new planes are needed on other decks, simply make sure you adjust the instrument's leveling screws at the new station until the plane rests at the same

height from the relevant reference marks. Always record the differences in elevation between various levels of reference marks and your actual transit reference planes. Failure to do so will make it impossible to align the planes directly at the drawing board.

headaches saved laying out points at the drawing board.

Setting Up the Instrument. When beginning, try to choose a station on the main deck from which a major portion of the deck can be seen, and from which you can see both port and starboard rails directly abeam from the instrument station. Actual set-up and adjustment of the instrument is a little tricky, because you will be using the instrument in a manner which is harmless to its mechanism, but one for which it was not designed. Aboard a vessel, the bubble levels ordinarily used to level the instrument are useless, except in a stable dry dock where the vessel itself has been leveled. When using the instrument aboard a floating or inclined vessel, first be sure the leveling screws are lined up port-to-starboard/fore-and-aft, and that you can sight points at the sides of the vessel directly abeam (see Fig. 4.3.37).

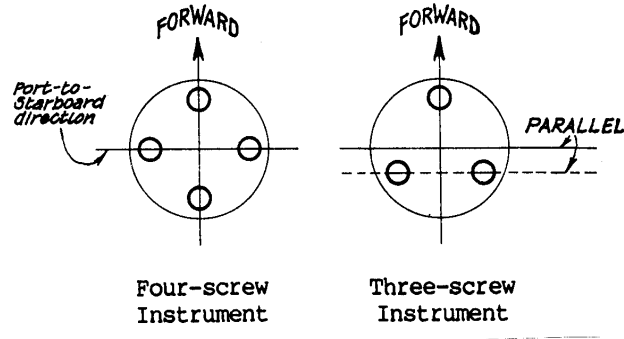
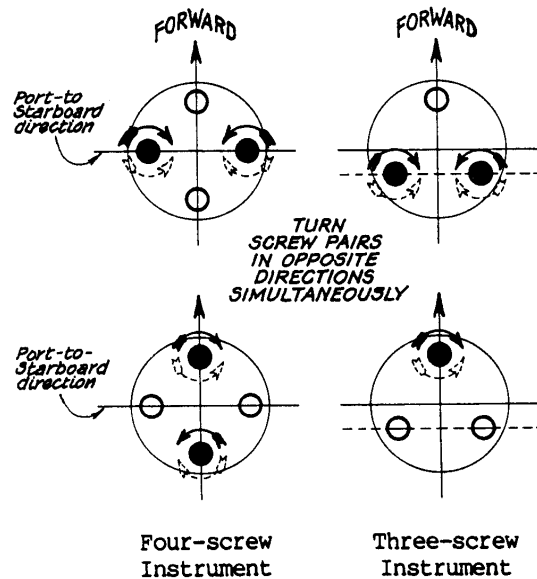

Fig. 4.3.37
Lining up Transit Leveling Screws with Ship Coordinates

This will greatly facilitate the leveling operation. Next, adjust the telescope's vertical swing until the vertical circle reads zero (0E0'0"), then lock the vertical. (Leave the horizontal circle free to rotate). Following this, the port-to-starboard leveling screws of the instrument are adjusted (*never* the vertical circle of the scope) until you can read the same heights through the scope on rods set up at the port and starboard sheer lines in a plane perpendicular to the vessel's centerline (see Fig. 4.3.38 and 4.2.39). This sets the scope plane level port-to-starboard with respect to the vessel.



FIRST:
Adjust
Port and
Starboard

SECOND:
Adjust
Fore and
Aft

Fig. 4.3.38
Adjusting Leveling Screws on a Transit

Where you level the scope plane fore and aft is a matter of choice. If the vessel is afloat, it is best to set the scope at *approximately* true level by using the "horizon" if it's visible. If the vessel is inclined or skewed, try to set the fore-and-aft orientation so that the plane is as nearly parallel as possible to the vessel's floating water line or the water lines to be used in your lines drawings. The trouble taken to make these arrangements will be more than repaid by the time and

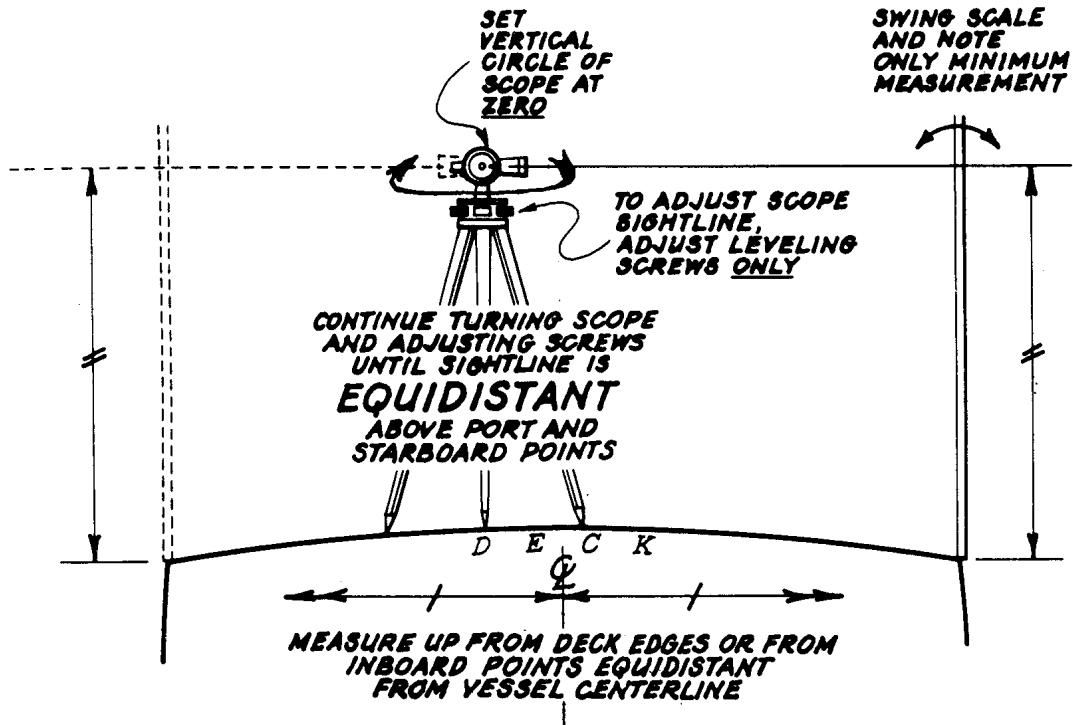

Fig. 4.339

“Leveling” a Transit Port and Starboard

Relative Horizontal Positioning

Plumb Lines and Levels. Aboard a stationary vessel, a plumb line or mason’s level can be used to record the relative horizontal position of one level surface to another, such as a forecastle deck to the main deck. Wind can raise havoc with a plumb bob, however, though immersing the bob in a bucket of water can damp the wind’s effect. Inside the vessel and over long vertical distances, a plumb bob will serve much better than a 4’ or 6’ mason’s level. There are many situations where the use of vertical-plane triangulations aboard a stationary vessel will save time and effort, however, so this technique should not be overlooked.

Vertical Triangulations for Horizontal References and Inclined Features.

Vertical-plane triangulations are essential when

recording the relative horizontal relationships of decks, platforms, and other level surfaces aboard floating vessels where plumb lines are useless. In profiles, the angles between bulkheads and decks can be recorded by triangulating the surfaces in vertical planes parallel to buttock or section planes (see Fig. 4.3.40). The same applies to masts, engine mounts, etc. Longer diagonals covering several features will prove useful as check-measurements. When recording things like the side of a deckhouse, or other trapezoidal shapes, measure all edges and both diagonals (see Fig. 4.3.41). If one or more edges of such surfaces are curved, you may have to set up a string or chalkline for an arbitrary reference and record the curve by a series of offsets. (Don’t forget to note the dimensional locations of such reference lines.) This shouldn’t be necessary where the curved edge meets a deck or hull surface, since the deck curve and other

surfaces should have been established already. Again, don't forget to shoot photographs.

Deck-to-deck Locations in Profile. Distances from the underside of one deck to the top of the next one lower down can be established by recording the minimum distance between them at the vessel's centerline (other locations may be dictated by circumstances). This is easily done at various points by holding the end of a tape to one surface, and swinging the tape near the other surface until you find the minimum. At the drawing board, this can be translated into a series of compass arcs, against which a ship's curve or spline can be fitted to draw the deck profile. Naturally, you should record where you take such measurements, and any special circumstances surrounding them.

Rigging and Sails. Unlike construction details, so much is known about rigging and sails that detailed documentation may not be strictly necessary from the point of view of new or significant information. However, since HAER documentation is vessel-specific, it would be incomplete without some coverage by photography and drawings of a vessel's rig when drawings of the vessel are warranted. Your project goals (which may include training, maintenance, replacement, replication, etc.) may argue for more extensive detail in this area than significance alone might. Your review team, vessel owners, and project cosponsors should be consulted in setting a scope of work in this area.

Rigging. Vessels are usually classified by their "rig"--the shape and location of their sails and the ways they are supported. Rigs can range from the fairly simple to the very complex. "Rigging" refers most commonly to lines (ropes or cables) that seem to festoon the vessel for support and control of the masts, yards, booms, and sails. You should be aware that rigs are often adapted to specific trades or regions, so be on the lookout for peculiarities and the reasons behind them. Ask your review team if there are

any unusual features about the rig on your particular vessel. Some vessels have undergone two or more changes of rig in their lifetimes. Unlike spars and standing rigging, running rigging was often changed when owners or captains preferred certain sorts of operational arrangements. Because of this, running rigging is on the average the least important to draw compared to standing rigging and spars; photography will probably cover the subject adequately.

If rigging is unfamiliar to you, it is probably best to start thinking of it as a series of systems

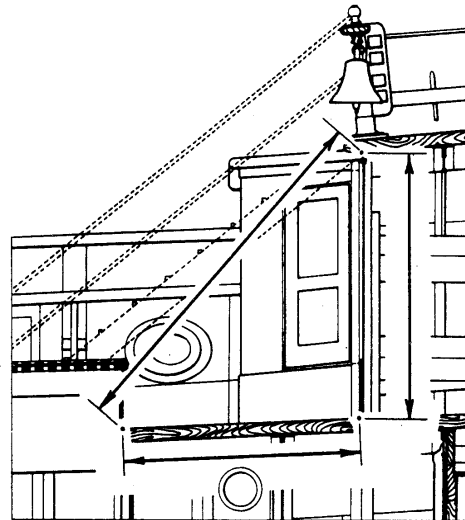
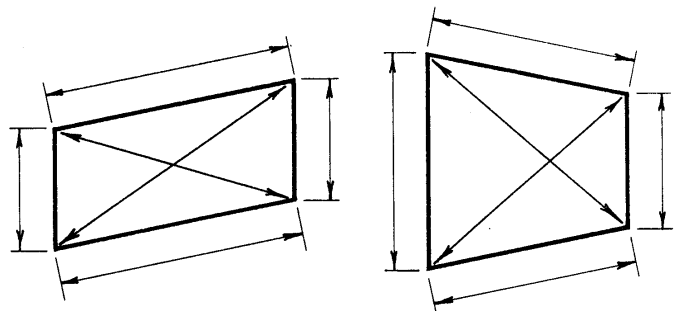

Fig. 4.340
Measuring Inclined Features



designed to hold up and control the masts and sails. The masts are braced to each other and to

Fig. 4.3.41

Recording Non-rectangular Shapes the vessel by the standing rigging, which needs only occasional adjustment. The sails, with attendant yards or booms, are controlled by running rigging, specifically designed and built for constant adjustment. Running rigging can be broken down into several sub-systems: one raises and supports the yards or booms, another raises the sails, still another controls the angle of the sails to the wind and to the vessel. Looking at rigging this way will go far to reduce confusion for those recording a vessel for the first time, and may help you more easily learn the names of the various spars, sails, lines, and line systems.

Sails. As with running rigging, recording sails can be problematical, since sails for most older vessels have been repeatedly replaced in service. Details of sail construction were a matter of the sailmaker's craft, rather than something done to sets of engineering drawings. Unless you have specific evidence as to the type and construction of sails used on your vessel for a specific period,

it is not prudent to show more than their schematic character in measured drawings. Measurements aren't necessary under these conditions. Evidence gleaned from historic photographs and other sources may be used if specific sources are cited in the final drawings.

In cases where sails deserve recording, there are several things you should be aware of. First, sails may not necessarily lie flat (i.e., without wrinkles or folds) if spread out on a floor. Secondly, they can stretch in service from the time of their manufacture, so that what you measure and draw is not their original shape. In any case, dimensioned sketches and photographs should be taken, and attention paid to significant construction details. A checklist is given below:

- 1) Dimensions of sides and diagonals, with the sail laid flat or stretched
- 2) How panels are laid (whether they are mitered, or parallel to the leech, luff, or foot)
- 3) Panel widths, seam to seam
- 4) Amount of roach (curve in either foot)

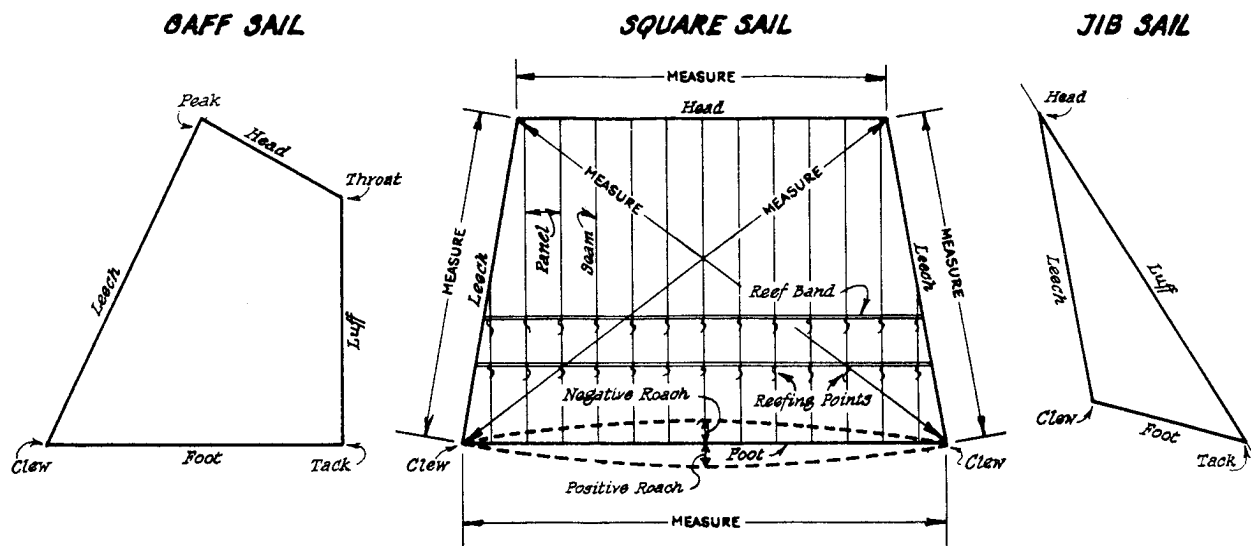

Measurements of panels, seams, reinforcements, reef bands, roach of leeches, etc. should also be made when sails are recorded. Measurements analogous to those shown for square sails above

should be made when recording other sail types. Many types of sail are not shown above, nor are all details indicated. Use of a reference book is recommended for detailed work.

Fig. 4.3.42

Measuring a Sail

- or leech; positive roach is convex, negative roach is concave)
- 5) Dimensions of leech panels, since this is where roach will show up
 - 6) Width of seams
 - 7) Width of tabling (perimeter seams)
 - 8) Size of stitches (number per inch)
 - 9) Location and size of reinforcing patches
 - 10) Distance between reef bands, and number of reefing points
 - 11) Materials and weight
 - 12) Maker's name, and approximate date
 - 13) How the sail is bent (attached) to spars or stays

Figure 4.2.42 shows the names and locations of some sail parts; further assistance can be had from a book such as Underhill's *Masting and Rigging the Clipper Ship and Ocean Carrier* (see Section 4.8 for full citation).

Recording Hints. Diameters of masts and yards should be taken as shape requires--some have straight tapers, others do not. Remember that the diameters of spars can be measured by taking their circumferences with a tape and dividing them by π (3.1416). To simplify and expedite the recording of masts and spars, record them with typical diagrams accompanied by tables in which the varying sizes and diameters can be put down. A similar approach can be used for details of fittings and construction.

Missing Rigging. On the other hand, it may be that the vessel you are recording has lost some or all of its rig. Telltale things such as holes in spars, blocks with no lines, iron fittings, and wear points, may all be clues to what once used to be there. Your project's goals and its review team should be consulted over whether to restore these things in the drawings, and on what basis. Other matters besides sheer historical

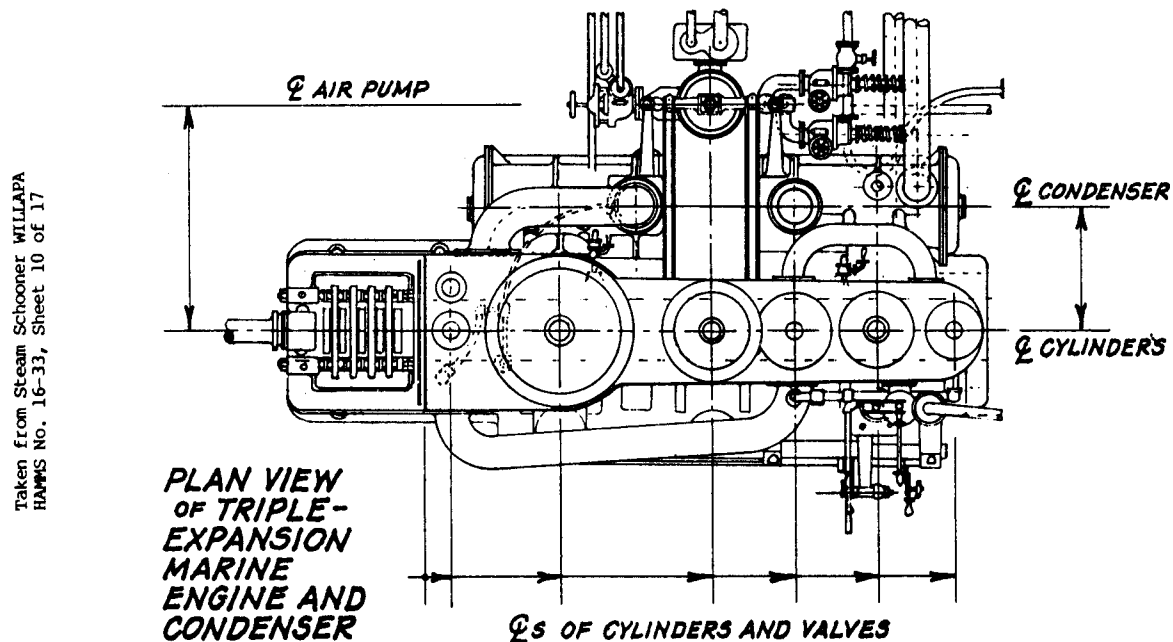

Fig. 4.343
Measuring to Centerlines of Objects

significance may be determining factors. Historical photographs or the recollections of a crew member can be of great importance in cases where graphic restoration is attempted. Speculation not based on physical evidence aboard the vessel, historical photographs, or other reliable evidence, is discouraged. In the late 19th century, sizes and proportions of lines, masts, yards, and other spars were set by specific formulas and published in tabular form by insurance companies (such as Lloyds of London). These tables can be of considerable help in the absence of other information. In some cases, speculation based on less reliable sources may be all you can present; if so, the speculative nature of your reconstruction and your sources should all be clearly noted.

Machinery. Nearly all vessels have some manner of machinery aboard them, even if it is no more than the steering gear or an anchor capstan. Decisions on how to record them (photos only? photocopies of existing blueprints? detailed measured drawings?) should reflect your project's goals and be made in consultation with the review team.

Old Blueprints or Shop Drawings. Unlike sailing vessels--which were mostly built from half-models, not sets of blueprints--full sets of engineering drawings had to have been made to produce any machinery you record. You may save much field and drawing time by locating surviving drawings and obtaining copies from manufacturers, trade catalogs, museums, archives, owners, and other sources. In some cases it may be wise to obtain permission to photographically copy drawings of significant machinery for formal inclusion in the HAER record photographs. Inclusion in the HAER record can only be allowed if copyrights to such material are waived (in writing) by their owner. (Even if HAER is not permitted to include such materials, copies of any drawings or other graphic materials used to prepare HAER drawings can be included in the field records, along with references from which further copies may be obtained by users. In such cases, locations of the original drawings should be

noted. Copies in the field records may also be simply referenced in the HAER drawings, even if they are not used to prepare the drawings.) Drawings should always be checked against the machinery itself, so that modifications and variations are not overlooked (these changes may be historically important). Do not try to scale engineering drawings without thoroughly checking them; written dimensions rule in engineering drawings, not scaled ones. In any case, information cast into the machinery's frames or embossed on builder's plates, etc., should be recorded for later inclusion in the final drawings. Such things as cylinder diameter and stroke, boiler pressures and tube sizes, pump bores, scale range of pressure gauges, capacities of pumps, horsepower of motors, diameter of propellers and propeller shafts, etc., should not go unnoted.

Field Measurement of Machinery. In the absence of pre-existing drawings, some field work on machinery will be necessary. Though some machinery may look extremely complex, boilers and engines, winches, donkey engines, steering gears, and other machinery fall into a fairly easy class of objects to record since they are designed around the centerlines of drums, shafts, frames, bases, or other major components. Recording work can be simplified and made more accurate by laying out your sketches and measurements around such centerlines (see Fig. 4.3.43). A triple-expansion marine steam engine, for example, has three (in some cases four) cylinders along with valve chests in line along a centerline over the main crankshaft (another centerline). Each of these cylinders with its main rods, crosshead guides, and so forth, are located around vertical centerlines lying square to and in the plane of these first two centerlines. Intelligent use of a dimensioned, schematic diagram of all these centerlines will eliminate a lot of unnecessary measurements (such as the gaps between cylinder heads) and permit you to lay out measured drawings more quickly later. Machinery is largely composed of circles, cylinders, rectangles, and boxes, and awareness of this can help you further streamline your

recording effort. As with masts and spars, the diameters of large cylindrical objects such as fuel tanks or boiler steam drums can be gotten most often by taking their circumference with a tape and dividing the dimension by π (3.1416).

Details. Hardware, moldings, and fittings should also be covered. These are the nitty-gritty features: anchors, blocks, fasteners, galley stoves, door hinges, pumps, cabin panelling, wheelhouse instrumentation...and on and on. You should set up a priority system for recording these (in consultation with the project historian and the review team), depending on the size and budget of the project. Some may be covered very well by photographs in which a measuring stick appears. You may, because of time, have to drop things of lesser significance which won't appear in the final drawings. Notes on materials (bronze? wood? glass?), colors, significant wear patterns, maker's names and model numbers, etc. should be jotted down. (Important colors should be recorded using the codes from a *Munsell Book of Color*.) Carvings and relief work can be recorded by making rubbings. Be on the lookout for telltale holes, incomplete fittings, patches, stains, wear marks, and other clues to pre-existing structure or uses. Even graffiti may tell you something.

Some vessels carry more recent equipment or even auxiliary boats--life boats, dories, etc. Determination of their significance should be carefully made before focusing too much time and attention on them. Remember, however, that equipment you may describe as being recent may be seen as historic equipment by someone several generations from now. Give this thought due consideration before you give a "recent" feature cursory documentation, or pass it up altogether.

Artifacts. While the recording of artifacts such as crockery, moveable furniture, tools, clothing, and the like is an important feature of maritime preservation, measured drawings of them are not undertaken by HAER except in cases of extreme significance. It is usually sufficient for HAER documentation to record such objects as part of

the general survey photography, or list significant artifacts in a written inventory. Images might appear in a HAER historical report.

Nautical Archeology. Many of the hand techniques covered to this point apply to recording vessels underwater. Numerous "high-tech" methods and instruments have also been developed for recording vessels at depths beyond the range of scuba gear. There are obvious limitations and advantages to working underwater which won't be addressed here.

Field notes are usually taken on plastic materials (polyester drafting films, acrylic panels, etc.) with pencils or wax markers. These notes are transcribed to paper at the end of each day's work; here HAER field note paper would be used if the project were being completed for submission to HAER. Underwater field photography is a vital supplement, though turbid conditions can restrict clarity. Hand drawn preliminary and final drawings proceed much as for floating vessels, using field notes and photographs to depict the resource as accurately as possible. It is standard procedure to draw the vessel and site "as-is" and seek to understand as much as possible about the vessel's history, construction and type before attempting any reconstructed views. See Section 4.7 at Figs. 4.7.65 to 4.7.71 for further discussion of archeological projects submitted to HAER.

FIELD NOTES

Planning Your Work. Field sketches, measurements, annotations, and field photographs should be made of your vessel with the finished drawings in mind, unless your project is designed to produce careful field notes of features for which finished drawings will not be made. A preliminary drawing schedule accompanied by a sketch layout of the drawing series will be invaluable in planning your field work. The recording team members can use the layout to divide various parts of the task up among themselves, coordinate work, and begin to develop an orderly series of notes. Careful thought at this point will prevent team members from rushing off to measure everything in sight without regard to significance or project priorities.

Sharing Expertise. Historians and delineators should make it a point to work together actively, comparing written records and physical clues aboard the vessel. Each will find things the other needs to know about in order to do his work more effectively and contribute to the overall quality and success of the project. If your project has retained a review team, be sure to take its observations of the vessel into account.

Field Notes are Primary Records. Reasonable care should be taken in producing all field notes. They are primary resource material and the basis for verifying the accuracy of your drawings under Standard II. Clarity and legibility are also paramount under Standard IV. Field notes are not only for production of your measured drawings, but for use by HAER staff in checking your work, and for use by future researchers seeking first-hand dimensional information about your vessel. Never treat field notes merely as personal scribbles whose only user will be yourself. Teamwork being the joint effort that it is, your notes will be used by other team members at their drawing boards or CAD stations. Hence notes must be intelligible to anyone. On HAER projects, finished drawings

are carefully compared with field notes in the HAER office to check for errors and perform any needed editing. When the measured drawings, photographs, and written data from your project are transmitted to the Library of Congress for accession in the HAER collection, *the field records must be included as verification for your work.* (Projects lacking field data--or documentation for other sources used as a basis for measured drawings--will be stamped with a disclaimer, and may possibly be excluded from the collection.) Researchers seeking a thorough understanding of a recorded vessel will often call for the field notes. Finally, if the vessel you record should ever need major repairs or become the subject of a reproduction project, the field records will be essential, since measured drawings do not contain the extensive written dimensional information needed for such work.

Simplicity and Neatness. It should be clear from Standard IV and from the many roles field notes play that legibility is a paramount concern. This does not mean that field notes must be finished works of art, but there are some general rules and hints that result in consistent legibility if you make such guides habits of mind.

1) Sketches made for dimensioning need only be freehand line sketches. Do not make sketches to scale--this is a waste of time except for full-size details (molding profiles of joinery work and the like). While attractive, techniques for illustrative rendering and shadowing are time-consuming and unnecessary in the vast majority of cases--such efforts should be saved for appropriate final drawings. A field photograph, properly lit, will suffice for pictorial data in the field. On your sketches, include dotted lines and make perspective "cutaways" or "exploded" views of details where orthographic views or photographs are not clear enough in presenting hidden internal structures (see Fig. 4.4.4). Notes should be included when exploded views

contain unconfirmed speculation about an assembly of parts, etc.

2) Break your subject down into appropriate levels of detail. The overall deck plan of a vessel in many cases need be no more than an outline of the rail or deck edge, with boxes or other simplified shapes for major features. This will leave plenty of room for you to fill in principal dimensions without crowding, and you will be able to retrieve information a lot more easily when you need it (see Figs. 4.4.1 - 4.4.3 for examples). A deckhouse might have several plans: the first plan might dimension only major openings, the second show internal structural features, the third any built-in furniture or machinery, the fourth deck plank seams, etc. A similar practice would apply to profiles or elevations of the deckhouse. Repeated elements of the same size (porthole frames, molding details, etc.) need only be measured in detail once, and simple outlines used on profiles which locate groups of features. Doors, for example, should be sketched and drawn in detail separately, knobs and special details separately again. Small details should be drawn full-size or larger, as needed for clarity's sake.

3) Analyze your sketches before making measurements, and insert dimension strings where you know you will need to make measurements. This way, it will be easy to check to see if you have obtained all your data--just look to see if every string has a dimension on it. Tables for scantlings serve a similar housekeeping purpose--see if all boxes are filled.

4) Dimensions and written notes should be in clear lettering, not hastily scribbled longhand. Field notes should be cross-indexed as appropriate. *All field records should be clearly labeled with the feature recorded, vessel name, recorders' names, current date, and the HAER project record number.* Field notes should be organized around specific views (e.g., lines, deck plan, inboard profile) and major features (mainmast, steering gear box, etc.). Each view or

feature should receive its own properly labeled folder.

5) At the minimum, sketches should be done in black, with dimension strings and figures in red to aid clarity under Standard IV. (Blue should be avoided because it does not photocopy well.) The use of a single color for all linework and dimensions is strongly discouraged. The multi-color system will allow a user to easily distinguish reference lines and dimension strings from sketches of recorded objects. Systems of measurements (diagonals, overalls, horizontals vs. verticals, dimensions taken along curves or in projected planes) can be distinguished by the use of a different color for each system. The effort expended in the conscious use of separate colors will be more than rewarded at the drawing board.

6) Try to make sketches and notes on only one side of each sheet of paper, and never put two different, unrelated objects on both sides of the same sheet. This will prevent situations where two team members both need the same field note sheet, but one person's work must be held up to permit the other to use the notes. If copies are made of two-sided field notes, sometimes notes made on the backs will show through.

7) The copying of field notes by hand is discouraged, not only because it takes extra time, but also because information can be *miscopied* in the process. If a field note must be redone due to damage or enormous error, the old should be included with the new (rather than discarded), and notes should be included explaining why the copy was made.

8) If you anticipate that the same sketch or view may need to be drawn several times in order to legibly record all necessary dimensional information, consider making xeroxes of the first sketch as a time-saver before dimensioning begins, convenience permitting.

Error Tolerances. Be sure error tolerances and any special conditions affecting the accuracy of your measurements accompany the affected figures, e.g., “pipe railing severely rusted, 2” dia. ∇ 1/4”.

Annotations. Important observations, local terminology, measurement procedures, conditions, cautions, speculations, nameplate data, etc., should be put down in your field notes. It is unwise to rely on memory, and future users on or off your project may miss important data if you fail to write it down.

Field Note Papers. HAER strongly advises the use of 17” x 22” sheets of good-quality white bond paper for field notes, printed with a blue grid of 8 lines to the inch. These sheets can be folded to 8-1/2” x 11” for inclusion in a standard folder, and the gridded lines facilitate sketching. The sheets can be taped or sparingly glued together as needed for greater length (a waterproof white glue such as “Elmer’s⁷” is recommended over tape or rubber cement for longevity and least discoloration with age). The use of odd scraps of paper, snatched from memo pads and other places, is strongly discouraged because they are easily lost. An exception to this rule is the use of xerox copied sketches or copies of partially completed measured drawings; they frequently make an excellent base for refined measurements or corrections.

There is no requirement that field note papers or folders be archivally stable (acid-free), in spite of the fact that they should be included as part of the project’s archival records. This is largely because field notes are frequently soiled with dirt, grease, perspiration, and other contaminants in the field. Every effort should be made to keep notes clean for legibility’s sake, but many vessels simply won’t lend themselves to “library” conditions without undue effort. This does not mean that archival papers should not be used if conditions or sponsoring organizations require it.

Media. No. 1 or No. 2 pencil is recommended as the best medium for field sketching. Pencil leads make good, dark lines, easily read or photocopied. Unlike inks, they can be easily erased and corrected if necessary. Smudging can be prevented by separating details from general dimensions, thus avoiding excessive labor on any one sheet. Harder leads are discouraged; they make very light lines which are difficult to see, do not photocopy well, and are easily obliterated. Mechanical pencils are recommended over the familiar wooden office pencil or a drafting lead holder because they do not require constant sharpening, and produce a constant line width. They are sold in a variety of sizes. Color leads are also available for dimensions and notes.

If inks are used, try a good quality drawing ink, or one that is NOT water soluble. Perspiration, mist, and dampness can make water-soluble inks bleed or run; sometimes they even transfer to other field note sheets when stacked or folded. While field note papers are not necessarily archivally stable, most inks contain oils, acids, or other chemicals which bleed across the paper, attack the paper itself, or cause the ink to fade over time. This may happen in as short a period as five to ten years, long before the paper itself deteriorates. The use of pencil exclusively will help your notes to last at least as long as the paper.

Forms for Lines-Lifting Data. Between pages 4.4.16 and 4.5.1 is a blank two-sided form suggested for recording lines-lifting data. It may be removed and copied. One sheet per section should be used, and one sheet for each side (port and starboard) if both sides of a vessel are recorded. A sketch (or even a scaled plot) of the hull section should be made in the upper half of the sheet, including any diagrams and critical dimensions of lines-lifting equipment used. Points on a section should be given letter names (“A”, “B”) so they cannot be confused with dimensions. Measurements for an individual point are recorded in a row across the form. In Fig. 4.4.5, the

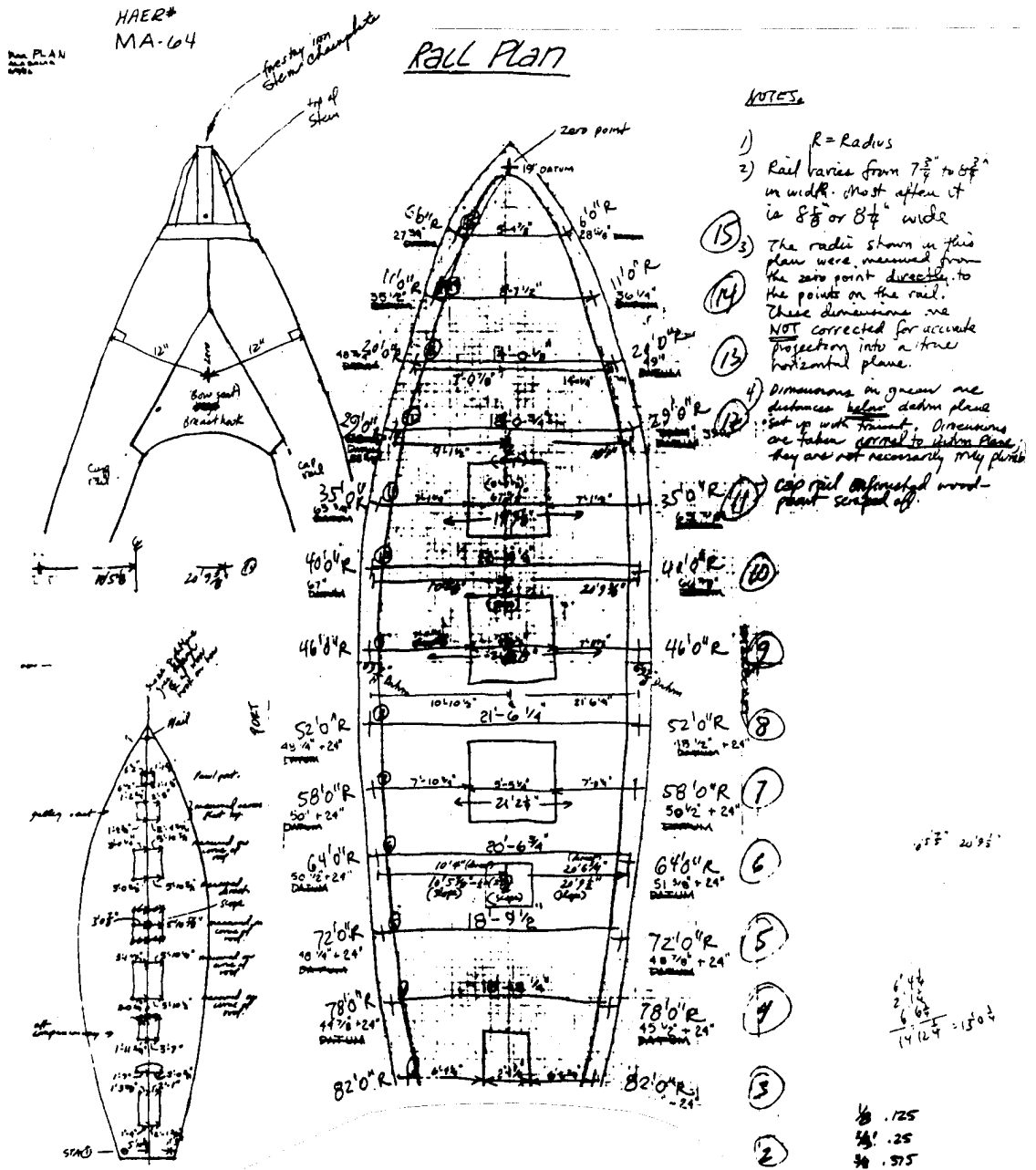

Fig. 4.4.1
 Excellent Field Note
 (reduced to 35% full size)

This field note is well executed for several reasons: each sketch performs only one function. A diagram of the vessel's rail at the bow shows where the field "zero" is for the purposes of recording the rail. The largest sketch gives only those vertical and horizontal data needed to draw the rail, nothing else. A smaller diagram records how the deckhouses relate to the vessel's centerline as set out by a transit, nothing else. Notes to the side present essential cautions to remember later at the drawing board. While this reproduction cannot show it, horizontal dimensions were recorded in red, vertical in green, to aid in distinguishing the two.

15-a

HAER*

MA-64

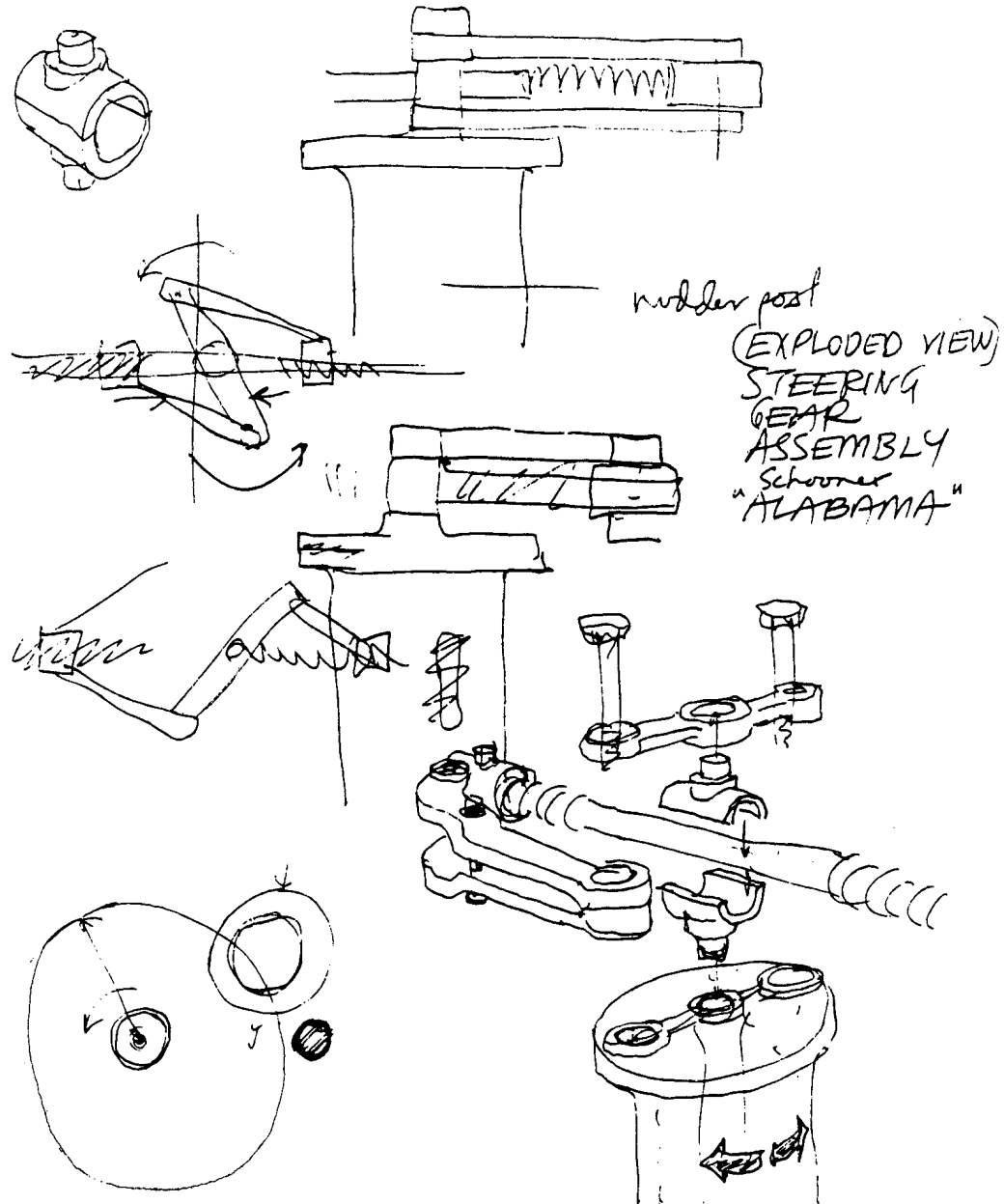

Fig. 4.4.2
Excellent Field Note
(reduced to 85% full size)

This field note is well executed for several reasons: each sketch performs only one function. A diagram of the vessel's rail at the bow shows where the field "zero" is for the purposes of recording the rail. The largest sketch gives only those vertical and horizontal data needed to draw the rail, nothing else. A smaller diagram records how the deckhouses relate to the vessel's centerline as set out by a transit, nothing else. Notes to the side present essential cautions to remember later at the drawing board. While this reproduction cannot show it, horizontal dimensions were recorded in red, vertical in green, to aid in distinguishing the two.

VESSEL: "EXAMPLE"
 HAER No: EX-1

STATION: 1 - STARBOARD

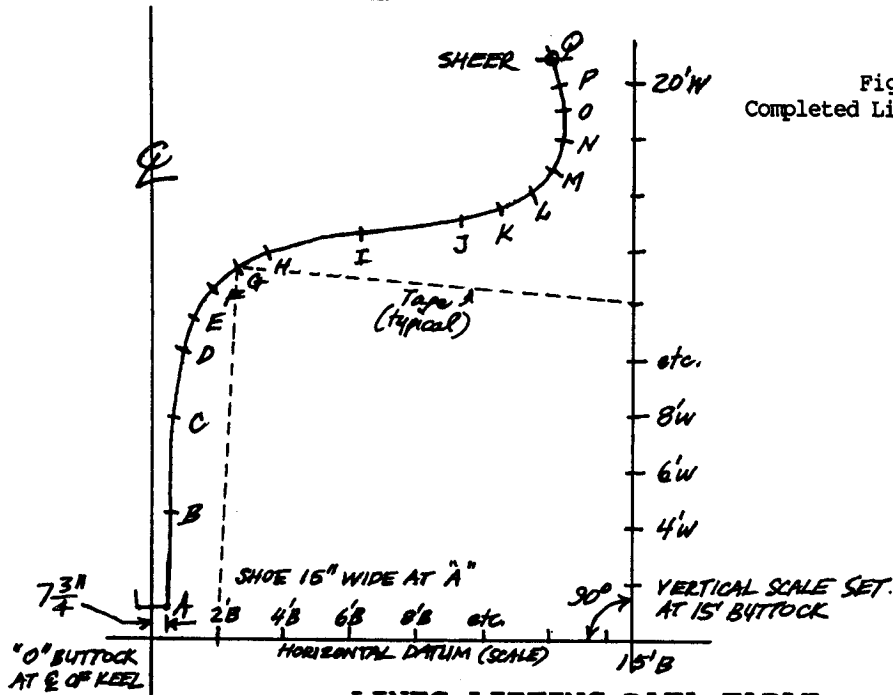

Fig. 4.3.5
 Completed Lines Lifting Form

LINES-LIFTING DATA TABLE

POINT	Tie	Tie	Tie	Remarks	POINT	Tie	Tie	Tie	Remarks
A	0" 4 1/2"			BOTTOM OF NORM SHOE	K	12B 15 1/4"	12W 15 1/4"	16W 3'0"	QUAD'S
B	1B 5'0 1/2"	4W 14 3/2"		1B = 1 FOOT BUTTOCK, ETC.	L	12B 16 2"	16W 2'5 1/2"		↓ ↓ ↓
C	1B 7'11 1/2"	8W 14 1 1/2"		4W = A-FOOT WATER LINE ETC.	M	17W 1'5 1/2"			MEASUREMENTS TAKEN 90°
D	1B 10 5 3/4"	10W 13'10 1/2"		B+W ON SCALES AS SHOWN ABOVE	N	18W 0'9 1/2"			TO VERTICAL SCALE AT
E	2B 1'5"	12W 13'8"		QUADRANTAL LATIONS	O	19W 0'7 1/4"			WATER LINES INDICATED
F	2B 12'3 3/4"	12W 13'2 3/4"			P	20W 0'7"			↓ ↓ ↓
G	2B 12'9 3/4"	12W 12'7"			Q	18B 21'8 1/4"	CHECK		SHEER
H	4B 13'4 1/2"	12W 11'5 3/4"			Q	21'4 1/2"	ABOVE HORIZ.		
I	6B 14'1 1/2"	14W 9'0 1/2"				0'9 1/2"	OFFSET FROM VERT.		
J	8B 14'11 1/4"	14W 6'2 1/4"							

DATE 9/30/87

ALL MEASUREMENTS +/- 1/4" UNLESS OTHERWISE NOTED

Fig. 4.4.5

Sample of Completed Lines Lifting Form

quadrangulations for point G on the hull, for example, were recorded on the line to the right of G (G being in the column for POINTS). The first box (with a diagonal slash) was used for the measurement of the first leg, and the second box for the second leg. The location on the buttock scale to which the first leg of the quadrangulation was measured is recorded to the left of the slash in the first box--the two-foot buttock is recorded simply as "2B"; to the right of the slash is the dimension between point G and the two-foot buttock mark on the buttock scale, 12'-9 3/4". In the second box, the location on the water line scale to which the second tape from Point G was taken is noted to the left of the slash--the 12-foot water line being recorded as "12W". The dimension from point G to the 12W mark is recorded to the right of the slash, 12'-7". The third column is provided as a back-up in case a third measurement should be desired, or to provide extra space in case a mistake is made in recording one of the earlier measurements. The REMARKS column can be used for notes, such as the physical feature at which the point was set ("bottom of worm shoe"), the condition of the hull at the point, or other information that will be significant in plotting and fairing the section properly.

Scantlings. Checklists for scantlings and important features on wooden and metal vessels are included on pages 4.4.5 to 4.4.12. These should be adapted as appropriate for your vessel. Consult your review team or a glossary for terminology or special-case structural members. Scantlings may be tabulated separately or included on field sketches in table or annotative form.

Tables. Recording data in tabular form can be a significant time saver when similar elements (yards, blocks, frames, panelling, etc.) are found in a variety of sizes. All tables should be accompanied by annotated field sketches.

SCANTLINGS for WOODEN VESSELS

Include cross-sectional dimensions, wood species, remarks about condition, repairs, replacement, etc.

A. BACKBONE

1. Keel (timber)
2. Keel (ballast)
3. Keelson or keel batten--also sisters and riders
4. Forward deadwood
5. Stem assembly
 - a) inner stem or apron
 - b) outer stem
 - c) gammon knee
 - d) gripe
 - e) stem knee
6. Sternpost and rudderpost
7. Horn timber, centerline transom timbers, fillers and cheeks
8. Stern knee and aft deadwood
9. False keel and worm shoe
10. Mast steps
11. Centerboard bedlogs and trunk
12. Shaft log
13. Rudder trunk

B. HULL

1. Floor timbers
2. Transverse framing, including knightheads, hawse timbers, and cant frames
3. Transom framing
4. Ceiling
5. Planking
6. Bilge Stringers
7. Sheerclamps and shelves
8. Grown knees (hanging, standing, and lodging)
9. Transom timber or beam
10. Pointers
11. Butt blocks
12. Garboards and broadstrakes (if different from other planks)
13. Sheerstrakes and walestrakes (if different from other planks)
14. Rail stanchions
15. Waist planking

16. Toe rails and cap rails
17. Guard rails and spray rails
18. Gunwales
19. Sheathing
20. Strapping
21. Limber (drainage) provision

C. DECKS

1. Transverse beams, main and intermediate
2. Carlins
3. Breasthooks and quarterknees
4. Fillers and blocking
5. Covering boards
6. Sills and grub beams
7. Waterways
8. Decking, including kingplanks and nibbing strakes
9. Lockstrakes and apron pieces
10. Mast partners
11. Sheathing

D. APPENDAGES

1. Rudder
2. Centerboard
3. Cargo hatches
4. Coamings
5. Companionways
6. Cabins and deckhouses

E. INTERIOR--BUILT-IN

1. Bulkheads--structural
2. Stanchions
3. Floor beams
4. Platforms, soles, and floorboards
5. Joiner bulkheads and partitions
6. Sheathing--hull and overhead
7. Seats and thwarts
8. Cabinets, lockers, berths, and shelves

F. FASTENINGS

1. Backbone joints
2. Hull joints
3. Deck joints

SCANTLINGS for METAL VESSELS

Include cross-sectional dimensions, metal type, remarks about condition, repairs, replacement, etc.

A. HULL LONGITUDINAL MEMBERS

1. Keel (bar, plate or formed section)
2. Keel (ballast)
3. Keelson (include any intercostal plating or swash plates)
4. Bilge Keelsons and Bilge Stringers (include any intercostal plating or swash plates)
5. Hold Stringers

B. HULL TRANSVERSE MEMBERS

1. Frames (include frame reverses and note direction of reverse)
2. Floor (note limber holes)
3. Bulkheads and Web Frames (include any stiffening angles)
4. Transom and Cant Frames
5. Knighthead Plates

C. STEM ASSEMBLY

1. Stem Bar
2. Stem Framing (web frame and brackets)
3. Forefoot Casting

D. STERN ASSEMBLY

1. Stern Post or Stern Frame
2. Rudder Post and Trunk
3. Skeg
4. Boss Plate
5. Oxtter or Tuck Plate

E. SHELL

1. Shell Plating
2. Bilge Keels
3. Rub Strakes
4. Ceiling or Sparring (include any ceiling clips)
5. Thru-hull Fittings
6. Inner or Double Bottoms
7. Hull Coatings

F. INTERNAL STRUCTURE

1. Mast Steps and Bowsprit Heel Stops

- | | |
|---------------------------|--------------------------------|
| 2. Machinery Foundations | c) Flush with external straps |
| 3. Centerboard Trunk | d) In-out Strake |
| 4. Shaft Alley | e) Joggled Plate |
| 5. Hawse Pipes | 4. Butt Arrangement of Plating |
| 6. Chain Locker Bulkheads | 5. Hull to Deck Attachment |
| 7. Integral Tankage | 6. Details of Built-up Members |

G. DECK

1. Deck Beams (include forged knees or riveted brackets)
2. Deck Plating (or wood over frame)
3. Stringer Plate
4. Longitudinal and Diagonal Tie Plates
5. Mast Reinforcing Plates (include partner angles and mast rings)
6. Machinery and Superstructure
7. Waterways (cement, wood, other)
8. Hold Pillars, Stanchions, or Girders
9. Engine Room Platforms

H. APPENDAGES

1. Bulwarks
2. Cargo Hatches
3. Cabin Trunks and Deckhouses
4. Fidleys and Engine Room Trunks
5. Coamings
6. Companionways
7. Access Ladders
8. Skylights
9. Ventilators and Stacks
10. Taff Rails and Fife Rails
11. Guard Rails and Spray Rails
12. Deck Lights and Port Lights
13. Mooring Bitts, cleats, and chocks
14. Rudder: Pintles, Gudgeons, Bearings

I. INTERIOR

1. Bulkheads
2. Joinery and Furnishings

J. FASTENING and ATTACHMENT DETAILS

1. Rivets (pattern, diameter and type)
2. Welds
3. Seam Arrangement of plating
 - a) Lapped or "Clinker"
 - b) Flush with internal straps

MACHINERY AND EQUIPMENT for WOOD OR METAL VESSELS**A. RIGGING**

1. Masts
2. Spars (yards, booms, gaffs, bowsprits, jib booms, etc.)
3. Blocks
4. Lines
5. Shrouds and Stays

B. PROPULSION

1. Engines
 - a) Reciprocating (steam or internal combustion)
 - b) Bore, stroke, number of cylinders
 - c) Shaft horsepower
 - d) Maximum r.p.m.
2. Turbines and reduction gears
 - a) Condensers
 - b) Shaft diameter
 - c) Propellers (number, diameter, pitch, number of blades, rotation)
3. Boilers (include stacks and breeching)
4. Fuel; Tankage or Bunkers
5. Auxiliary equipment (pumps, generators, compressors, lubricators, donkey engines, etc.)
6. Deck Gear (windlass, capstan, bitt, lugs, cargo gear, fishing nets, davits, etc.)
7. Steering System (linkages and emergency systems)
8. Navigational Equipment (running lights, bells, horns, binnacles, standard compass, etc.)
9. Armament (military, etc.)

NOTES ON HULL CONSTRUCTION DETAILS

The hull construction details of a particular riveted or early welded vessels can provide much information on engineering standards, shipbuilding methods, and available materials and technology of the era in which the vessel was built. For this reason, the following details are worth documenting:

Shell Plate Thickness. Getting shell plate thicknesses can be a real chore. In riveted construction, the thickness of shell plates will often vary from strake to strake. Plate thicknesses should be measured not only at the mid-half-length, but also at the ends, where scantlings were generally reduced. In some cases the scantlings will be lighter at the stern than at the bow.

Original plate thicknesses may have been gauged in various increments. Vessels built in the British Isles were often constructed of plate in 1/20" or 1/16" increments. Plate in U.S.-built vessels was measured in pounds per square foot or standard fractions of an inch (10-pound plate is 1/4" thick). European builders used metric measurements, or in some cases, nonstandard measurement systems peculiar to the building nation.

Getting measurements of original shell plate thicknesses is made difficult when extensive corrosion has occurred. With "in-out" strake construction, in-strakes can be measured at the inside plate laps. The out-strakes can be more difficult as exterior corrosion affects the thickness of the entire plate. The same problem is encountered in flush butted riveted and

welded shell plating. In these cases, documentation of original plate thickness (absent builders' or insurers' records) may not be possible to any high degree of accuracy.

Butts and Seams. A combination of two or more seam or butt arrangements may be found in a vessel. A common example is the use of "clinker" or lapped seams below the waterline and flush seams for topsides.

Rivet Type and Riveting Patterns. Rivets can reveal as much about an iron or steel vessel as fastenings do of wooden construction. Their type and pattern are indicative of available technology and quality of construction. Rivet type is mostly restricted to diameter and type of head. Rivet patterns are numerous, but usually involve staggering or multiple rows. Rivet patterns are measured in "gauge" and "pitch."

Classification societies, such as Lloyds, often required more rivets in shell plate butts in the mid-half-length of a vessel than at the ends. Documentation of hull rivet patterns should therefore be made in the bow and stern sections as well as near midships.

Other aspects of riveted construction which should be documented are use of felt in seams, and caulking of seams. These methods of achieving water tightness can indicate the quality of repair work or original construction.

(Material on pages 4.4.11 - 16 is based on work supplied to HAER via Mystic Seaport Museum by Don Birkholz, Jr., of Santa Cruz, California.)

VESSEL: _____

STATION: _____

HAER No: _____

LINES-LIFTING DATA TABLE

FOUNT	Tie	Tie	Tie	Remarks	FOUNT	Tie	Tie	Tie	Remarks
					Continued on reverse				

HAER 9/30/87
Revised 9/2/88

ALL MEASUREMENTS +/-

UNLESS OTHERWISE NOTED

NOTES:

Continued from reverse

POINT	Tie	Tie	Tie	Remarks	POINT	Tie	Tie	Tie	Remarks

FIELD PHOTOGRAPHS

Field photographs, usually 35mm black- and-white, are taken by recording team members to supplement their field notes. As with other HAER field records, these are primary sources of information which are ultimately transmitted to the HAER collection along with field notes and finished drawings. They are not only for your use at the drawing board and for other team members' use in their research, they also serve future researchers, and the HAER office in reviewing your work after the completion of the project. On rare occasions, a field photo may be used as a formal record photograph in cases where spaces are too confined or too precarious to set up a view camera.

Digital photography is not considered an archival medium, and therefore is not recommended for use in HAER documentation. It can be useful in the production of your work product. Future standards may be developed for this. Laser -printed or xerox copies of digital images can be included in the field notes and labeled as such.

It is wise to shoot field photos as early as possible so that processing time doesn't interfere with their use in the drafting room.

EQUIPMENT

Basic equipment is listed below:

- 35mm camera
- assorted lenses (35mm wide angle, 55mm normal, and 135mm telephoto or zoom lens)
- flash
- tripod

In 35mm format, an SLR (single lens reflex) camera is by far the best to use, since most models permit lens changes, exposure adjustments, and direct focus control; automatic focus and exposure cameras may not perform

well in situations with great variations in depth or lighting. A flash (or photoflood lamp) will obviously serve in dimly lit areas, and can be used to fill in shadowy details on bright days. (Be careful and avoid hot spots in photos from the flash bouncing off shiny surfaces or from being too close to the subject. Also, be sure to check bilges and other areas for explosive fumes that might be ignited by an electrical discharge.) A wide range of lenses or focal lengths gives great flexibility. Wide angle lenses can be used for general surveys or cramped spaces where longer focal length lenses don't "pull in" the desired view. Be careful in using them for shots that you intend to use at the drawing board as an aid to field measurements, since these lenses characteristically distort dimensions at the edges of the photo. A 55mm (normal) lens introduces the least distortion in these cases. Telephoto or zoom lenses permit you to catch exterior or interior details that are at inconvenient heights or distances, and can be used to supplement field notes of elevations which have moderate projections or recessions from the elevation plane. Photographing an elevation from a distance with a long lens compresses the nearby foreground and background, a distortion which places them in nearly the same scale as the main elevation plane. The longer the lens, the better the effect, though stepping back far enough on a vessel may be a problem, and higher shutter speeds or a tripod may be necessary to prevent blurred images.

FILM

Black-and-white: HAER teams should use Kodak Plus-X (ISO 125) and Tri-X (ISO 400) film, or equivalent. *Avoid C-36 processed black-and-white film as this is not archival.* The higher speed film permits shots in dim areas without a flash, but with some sacrifice in definition if enlarged. The slower speed is better

4.5.2 Field Photographs

for brighter light, and negatives can be enlarged with better preservation of detail.

Color: Color film can be used for field photography, however, color films and prints do not have the archival stability of black-and-white.

Store all film in a cool place. Don't leave film or cameras in vehicles or tool boxes in the hot sun. Excess heat shortens film shelf-life and alters its exposure characteristics. It may also damage sensitive camera and flash electronics.

PROCESSING

Black-and-white film should be processed locally, as soon as is practical for use in the drafting room.

Always order a contact print first; prints and enlargements should only be ordered as necessary. If available, obtain archival processing for contact prints. Basically this only involves an extra processing step in which negatives and prints are put through a hypo-eliminator bath to neutralize excess fixer chemicals.

Digital Photography. Cameras are now on the market which record photographs electronically on small optical disks or internal memory banks for playback on a computer. These systems dispense with film and processing altogether. While electronic formats are easily analyzed and manipulated by computers for use in CAD systems or electronic imaging, they leave behind no easily reproducible archival hard copies, and thus fail Standard III. Electronic technologies grow obsolete quickly, rendering electronically formatted images inaccessible to future users at the Library of Congress long before film negatives deteriorate. Film images can always be input into contemporary technologies at the convenience of future researchers.

CAPTION SHEETS

A Field Photo Identification Sheet must be filled out in the field for each contact sheet by the photographer who took the photos (see Fig. 4.5.2). The Field Photo Identification Sheet is completed by giving the HAER number, name and location of the vessel, the name of the photographer, the date the photos were taken, and a description of each frame, one frame per line. (Unidentified photos fail to meet Standards II and IV.). Each view should be numbered according to the frame numbers appearing on the edges of the negative strips; if certain exposures did not turn out for any reason, this should be noted (i.e., "blank," "underexposed").

At the end of the project, all contact sheets, negatives, and enlargements must be returned to the HAER office. Please be sure *all* photo materials are properly labeled and filed. Staff members in the HAER office have neither the time nor the familiarity with your vessel to do this for you.

Transmittal Preparations. After processing, each contact sheet and its corresponding film strips should be identified by a film roll number (see Fig. 4.5.1) and a HAER record number on each contact sheet and film strip (label the film strips between the sprocket holes with drafting ink and a #0 [.35mm] pen) or a fine "sharpie" type permanent marker. Each film strip should be placed in a separate, acid-free archival envelope (supplied by HAER) and the envelope labeled in No. 1 pencil with the roll number and HAER number.

These considerations do not preclude the scanning and electronic analysis of film images, however, for projects or contractors equipped with proper systems and software. Film negatives and contact prints still must be submitted for transmittal to the Library of Congress in order to meet the *Secretary's Standards*.

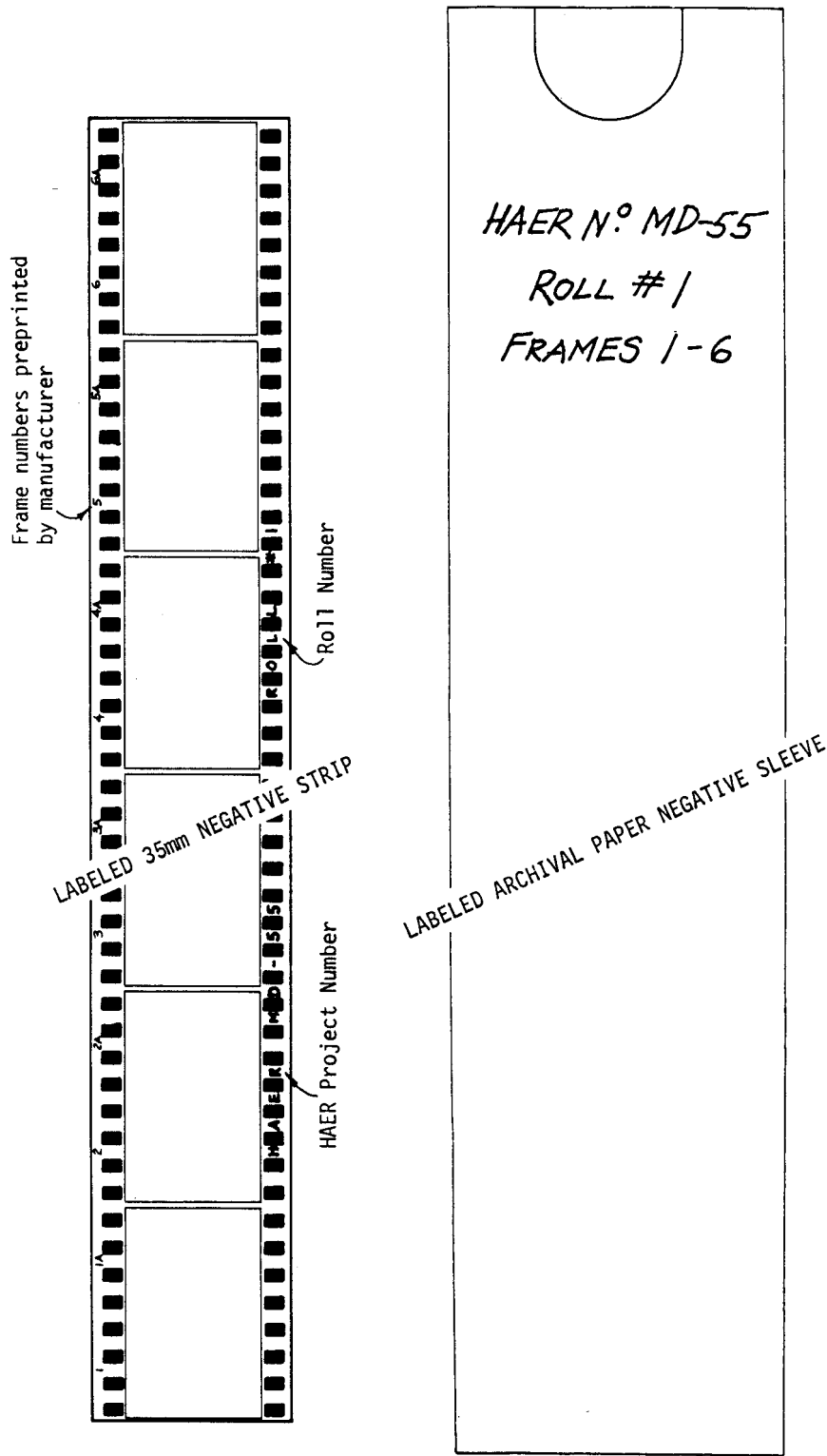

Fig. 4.5.1
Field Film Labeling

4.5.4 Field Photographs

(PRINT LABELING)

Bow of Ship

SS Boat

HAER No. DC-33

Use No. 1 pencil or "sharpie"
type marker on plastic paper

(CONTACT SHEET EXAMPLE)

--	--	--	--	--	--

--	--	--	--	--	--

--	--	--	--	--	--

--	--	--	--	--	--

National Park Service Field Photo Identification Sheet

Building/Site		Date	HABS #
Location		Field Film #	HAER #
PHOTOGRAPHER			
Frame	View	Frame	View

WASO-31

Fig. 4.5.2
Field Photo Caption Sheet

WHAT TO SHOOT

The applications for field photographs are numerous. General survey views of a vessel are the first order of business, covering such things as side profiles, the bow and stern (end-on and quartering views), main deck layout, masts and rigging, major compartments and machinery spaces, etc. These sorts of photographs can be very useful in all phases of the project. However, field photographs should especially cover assemblies (framing and rigging connections, steering gear, etc.), details (carvings, hardware, rivet patterns, machinery, etc.), and special conditions (wear patterns, repairs, places where items are obviously missing, construction details exposed by deteriorated fabric, etc.). Photographs also capture data about materials, textures, finish, relative placement, numbers of planks and rivets (and so on) far more quickly and concisely than could ever be done by sketching and measuring. Some photos can save considerable time over laborious field sketches, though they are no substitute for copious measurements with suitable written annotations in most cases. At the drawing board or computer, photos can be used to double-check and straighten out confusion in field notes without going back to the vessel in many cases. Minor errors and omitted details in field notes can be corrected or filled in from 35mm photos.

In some circumstances you may find more information in negatives than in your prints. If you have problems seeing important details in an unexpected shadow of your contact print or enlargement, examine the negative under an 8x eye loupe. Be sure to protect the negative strip from fingerprints and scratches by using a temporary plastic negative file.

Time is usually at a premium on a field team, so you should reserve dimensioned sketches for more significant aspects, and fill in minor details from field photos. Aside from backing up measurements, photographs can be used to document and count things like steps, bungs, rivets, portholes, and the like. Set up as “rectified” photographs, field photos can be shot of certain kinds of features, then enlarged and traced for inclusion in a measured drawing, thus saving a lot of hand sketching and dimensioning. These features should be limited to things that lie in fairly flat planes (like deckhouse sides or the ship’s wheel), since parallax errors unavoidably introduced by perspective effects can cause scaling problems or unacceptable distortions in objects that project or recede from the subject. The longer the lens you use, however, the more compressed a photo’s foreground and background will appear and the less the parallax error. Projections and recessions will gradually approximate the scale of the subject as focal length increases. Aboard ship you may be limited by deck area from using a long lens effectively for rectified shots.

Scaling the diameters of round objects like masts from photographs should be avoided--parallax effects almost inevitably lead to errors.

Scale Sticks. Even though you may have recorded the dimensions of photographed subjects in your field notes, the presence of a scale stick in each view enhances the photograph’s verifiability (Standard II).

One of the best kinds of scale stick for legibility purposes is one painted in alternating black and white stripes, each one foot long. For small details, a stick painted in inches or fractions of



Fig. 4.5.3
Effective Photo Scale Stick

an inch will be useful (see Fig. 4.5.3). Folding rules and tapes can be used, but it is difficult to read their graduations when the camera is more than ten feet away.

The inclusion of one or more legible scale sticks in the plane(s) of the object you wish to record is advantageous and highly recommended, but not essential. If a horizontal or vertical datum plane passes through the photo field, you would do well to mark it (tight string or chalk line) so the camera can pick that up also.

Rectified Photographs. A fast and accurate way to set up a rectified photograph only requires the use of a mirror fixed in the plane of the subject whose image you wish to record. Your camera should be an SLR (single lens reflex) mounted on a tripod. As you look through the viewfinder, center the *reflected image of the camera lens in the mirror* in the center of the split-image (or microprism) focussing zone in your camera's viewfinder (see Fig. 4.5.4). This will position the lens axis normal to the mirror plane and to the surface to which it is attached. The larger the mirror, the better its parallelism to the subject's surface can be assured. This method results in an undistorted image for the plane in which the mirror lies. (The mirror can be removed once the camera set-up is complete.) Don't forget to include a scale stick.

SCALING FROM FIELD PHOTOGRAPHS

Below, six methods are described for deriving dimensional data from field photos for measured drawings:

1) Count standardized or regularly spaced objects whose dimensions or spacing are known (e.g. strakes, planks, frames). The dimensions of nearby features can be estimated by using these things as "measuring sticks". Keep in mind that your error tolerance is higher than for direct field measurements, and annotate your final drawings accordingly. This technique is especially useful for inaccessible heights or

features whose significance does not justify the time to physically measure them.

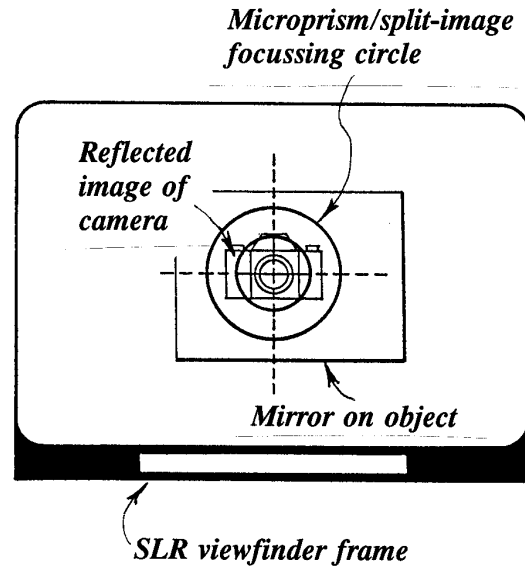

Fig. 4.5.4
"Camera's Eye" View of Rectified
Photo Setup with Mirror

2) Measure the photographic image and transfer dimensions to a drawing. This works best with a rectified photograph, but it can be cautiously used with oblique views to fill in minor details. Sometimes oblique views can be rectified with proper darkroom equipment, but this is not usually feasible with the commercial photo services available to field teams. You should record the object's principal dimensions in field notes as a way to limit and double-check against dimensional errors, even for photos in which scale sticks are included. Once you have the photos and principal dimensions, you can derive the dimensions of details from simple proportional calculations (see Section 4.5).

3) Trace enlargements of rectified photographs, then photographically enlarge or reduce the tracing to the scale of final drawings. Do not go to the trouble of trying to order an enlargement of the field photograph to a specific scale (something most photo labs will not do, or won't do accurately, cheaply or quickly!).

4.5.8 Field Photographs

4) Combine overlapping rectified photographs into a collage for tracing things like plate patterns on a hull, carving work on interior joinery, etc.

5) Digitize and rectify film images. There are computer programs on the market which can scan and analyze photographic images, rectify oblique photos and correct distortions, thus producing an image from which a drawing (or portions thereof) can be traced digitally. The tracing can be plotted for use as an underlayment for a hand-inked drawing, or transferred to a CAD drawing file. It is a good idea to have overall hand measurements of the shape and scale of the object you photographed handy to check the output for accuracy rather than rely solely on software to “automatically” produce a correctly scaled image. There is no requirement for submitting digitally processed images for transmittal to the Library of Congress.

6) Use reverse perspective analysis (by hand or computer-aided) to derive dimensions of more or less accuracy from historic or modern photographs of adequate quality. This method is based on the geometric laws of perspective.

DIGITAL PHOTOGRAPHY ISSUES

Digitally produced photographs are accepted by the Library of Congress, however, the library does not accept the digital storage medium. A print or contact sheet must be produced to submit with the field records. These prints can be made using photo paper printers, laser printers or xerox machines. Again, black and white images will last longer and it is recommended that photos be converted to grayscale for printing. Contact sheets or “thumbnails” can be produced using various computer programs developed for use with digital cameras.

MEASURED DRAWINGS

HAER's goals for drawings are derived from the *Secretary's Standards*:

FIRST, that drawings address historically significant aspects of a vessel, whether those be related to hull model, construction technology, rigging and propulsion technology, workmanship and finish, historical events, or any combination of these and other factors.

SECOND, that drawings be accurate and verifiable--that is, that they be accurately scaled and delineated from accurate field notes; that they be dimensioned; and that an adequate accounting be given *on the drawings* for measurement procedures, errors, separate sources, speculation, incompleteness, etc. Drawings should be backed up by adequate field notes and other data. (A more detailed accounting should be given in a Field Report.)

THIRD, that the drawings be made on archivally stable HAER sheets which are easily reproducible.

FOURTH, that drawings be clearly and crisply delineated, graphically "readable," strong, and attractive both in their linework and lettering so that their data are unambiguous and will withstand the effects of reproduction and size reduction.

Measured drawings of a vessel are more than a direct translation of field measurements into line drawings. To meet the *Secretary's Standards*, they must not only be accurate as to content, but also employ effective graphic techniques. A drawing's ability to store and present information depends on a combination of intellectual and aesthetic principles. The guidelines that follow are derived from

thousands of man-hours of HAER experience. The reasons behind the guidelines are varied--some reflect archival concerns, others documentary, legibility, reproducibility, and presentation concerns. There are also a series of measured drawings reproduced with comments in Section 4.7 to illustrate many of the principles discussed in this section.

HAER strongly encourages high-quality delineation and graphic techniques, and insists that verbal verification be provided on drawings, both to provide further information and to check misleading assumptions or implications that users may possibly draw. There may be some who believe they cannot meet the drafting standards HAER sets. HAER is in part a training program, and the guidelines provide delineation help "by precept and example" to those who may need it

If documentation of important historic resources is worth doing and is worth making last to the 20th generation of one's descendants (500 years), then it's worth doing well. For those who sponsor documentation projects, it is well to note that aside from purely documentary purposes, attractive drawings are also publishable and saleable items for museums, preservation groups, fund raising efforts, etc.

HAER has attempted to write drawing guidelines with the needs of both HAER and users from the general public in mind. They reflect HAER's viewpoints and hence may differ from those of other authorities. However, they are intended primarily to govern work done for the HAER collection, in the expectation that they are sound enough to be approved by other interested parties and professionals. If studied carefully, these guidelines should enable even amateur delineators to produce credible work.

4.6.2 Measured Drawings

However, success will depend to a large extent on the delineator's previous experience, on his ingenuity, diligence, and sensitivity to the complex tasks of documentation.

Hand Drawing and Computer Aided Drafting (CAD)*. The guidelines to follow are based on years of hand drawing experience and are addressed primarily to hand-drafted drawings. CAD machinery is replacing hand drawing in many fields because of time (and money) savings it offers. By whatever means HAER drawings may be produced, the *Secretary's Standards* still apply, and the rules for content and graphics will still apply, notwithstanding the change in drawing tools and methods. Since CAD programs vary and are subject to upgrades, these guidelines make no attempt to give CAD instructions other than as performance or results-oriented directions.

CAD GUIDELINES ARE AT THE END OF THIS CHAPTER

BASIC VIEWS

The drawing set for a vessel should be organized generally as follows:

Title Sheet

Lines

Construction Drawings

Outboard Profile (starboard side conventionally, port side if it is the only good one)

Inboard Profile (showing internal arrangement of structure, spaces, and equipment)

Main Deck Plan (often showing framing on one side of centerline, deck arrangement on the other)

Other deck plans

Sections (showing internal arrangement of structure and equipment)

Propulsion (sail and rigging plans and/or mechanical propulsion)

Details (structural joints, fasteners, fittings, joinery machinery, carvings, etc.)

Interpretive (process, concept, or schematic drawings that illustrate the vessels function)

Scantlings, a list of structural member sizes and materials, should appear on one of these views. Drawings may also include tables, diagrams, or other means of systematizing information.

Number of Drawings. Not all vessels will receive this complete a coverage, nor is it necessary to devote a minimum of a single sheet to each view or subject listed above (the main and 'tween deck plans might appear on the same sheet for some vessels, for example). The extent of documentation should depend first on the vessel's significance and the importance and number of specific features aboard it, though other planning factors involved in your project's goals will unavoidably affect the content of the drawing set.

Further instructions on sheet content, layout, and execution will appear under other topics in the remainder of this section.

DRAWING SHEETS

For archival stability, only acid-free polyester materials or "buffered" vellums are recommended for finished measured drawings. Each of these materials has pros and cons in terms of characteristics. Vellums are usually cheapest, but are difficult to erase ink lines from without disturbing the drawing surface; they also can tear easily, and changes in humidity cause them to expand and contract. Linens are very durable, but appear to be unavailable, having given way to plastic-based drafting media.

Polyester-based materials (often called Mylar⁷, a trade name) are available in rolls and cut sheets, usually in thicknesses varying from three- to five-thousandths of an inch, and with a drafting surface on one or both sides of the sheet. While considerably more expensive than vellum, drafting film is much more translucent, durable, easily erased, and is unaffected by humidity changes. Archival materials should be used whether your drawings go into the HAER collection or not, simply as a means of preserving your effort.

Drawing sheets should never be folded; the creases become areas of structural weakness, collect dirt, and spoil the image. Sheets should be stored flat, or at worst, in a roll.

PRELIMINARY DRAWING SHEETS

Before final drawings can be made into HAER drawing sheets, preliminary drawings must be produced to plot field measurements, work out conflicting data, and develop views and sheet layouts. Preliminary drawings are not made a part of the HAER collection at the Library of Congress. However, electrostatic copies may be included with field records in those cases where considerable reconstruction was done or other procedures used which cannot be conveniently shown in the final drawings. If HAER office staff cannot make a field visit, "in progress" copies of your preliminary drawings should be sent to the HAER office periodically for review, especially before final ink drawings are begun.

Either vellums or sheets of mylar cut from a roll may be used for preliminary drawings, though mylar is the better material for reasons discussed above. It is strongly recommended that preliminary drawings of deck plans and profiles be drawn as single views, regardless of length, rather than drawing them in several pieces (as if to put them individually on HAER drawing sheets or other similar size media). This ensures that curves will be fair and that any future sheet

divisions will match at cut lines. Long centerlines can be generated by stretching a piece of strong, fine thread as a guide for parallel bars or stainless steel straightedges. (It is best to put such reference lines as well as grids on the backs of sheets where they cannot be affected by erasures to linework on the fronts.) Preliminary linework is better done with a 4x0 ink pen (on mylar) rather than pencil--it is easier on the eye since the contrast is much better, and ink won't smudge as badly under sliding triangles and other instruments. Plastic leads for use on drafting films do not hold a fine point well. Write down notes on the sheets as you think of them for possible inclusion in final drawings. Principal dimensions from field notes should also be copied onto your preliminary sheets so you don't have to search for or recalculate them again later.

You may find it advantageous on large vessels to set up one or two long drawing boards having 4'x8' or 4'x10' tops for the production of long views. Two delineators can work at such a board without hindering each other. Aboard large vessels with complex machinery spaces, a team may find it beneficial, as a temporary expedient, to trace the general compartment layout from the full-length view, then set up a small drawing board in an individual compartment to work on that particular space.

HAER DRAWING SHEETS

*If your drawings are being produced for HAER, your choices of drawing sheet size, material, and graphic media are rigidly specified, due to the limits of the storage facilities and archival requirements at the Library of Congress where the HAER collection is maintained. (See the *Secretary of the Interior's Standards for Architectural and Engineering Documentation* in Section 4.8.) These specifications are non-negotiable, and failure to follow them will*

4.6.4 Measured Drawings

mean return of your work, regardless of its merits.

The HAER Drawing Sheet. HAER provides three sizes of polyester sheets with a standard HAER preprinted border and title block. The sheet size and actual drawing area are given below:

19"x24" (15 3/4" x 20 1/8")

24"x36" (21-3/4" x 31-3/4")

33"x44" (31 3/4" x 39 7/8")

CAD templates are available.
Contact the HAER office

The smallest size is rarely used. Mixing sheet sizes in a drawing set for a single vessel is not permitted; all sheets must be of one size.

The HAER polyester sheet is double-matted (i.e. has a frosted drawing surface on each side) so that inking may be done on either as the need arises. Reserve the front side for all linework and labeling, and use the back for lines grids, pochés, and rendering (e.g. deck planks). This way, if mistakes are made in drawing lines or rendering cross sections of materials, they may be easily erased without disturbing prior linework. Most erasures can be made very easily by using a slightly moistened drafting film eraser. Oily fingerprints and smudges, which cause freshly inked lines to bead, can be quickly removed with naphtha (lighter fluid) or a chamois cloth without removing previously inked lines. (*Never* use acetone or aromatic solvents like toluene--these destroy the drawing surface.) Solvents leave no residual grit to accumulate on or clog pen points as some powdered drawing cleaning products do. Ordinary rubbing alcohol (70% isopropyl alcohol) will remove dried ink lines from drafting films very quickly. The drawing surface of HAER drafting film is not ordinarily impaired by rubbing alcohol, but the surfaces of some brands of drafting film are whitened or removed by this solvent. Test a

corner of your material before applying any solvents to any make of drafting film.

HAER sheets should be used only for final drawings. Preliminary pencil work, whether in non-photo blue or other media should be done on separate materials, never on the HAER sheet. Aside from smudging, pencil work can leave ghosts on reproductions, and erasure of it wastes time and damages inkwork.

Sheet Orientation. Only two orientations of the HAER drawing sheet are permissible:

- 1) HORIZONTAL with title block to the RIGHT
- 2) VERTICAL with title block at the BOTTOM

Integrity of Borders. The borders of the sheets may be broken when the orientation, scale, or presentation of a subject particularly requires it, but this should not be an excuse for contrived effects or for cramming a view onto a single sheet that would fit better at a smaller scale, or onto two sheets.

Trim Lines. *Do not* trim the mylar sheets at the "Trim Line" marks. The edges of the sheets are never to be trimmed. HAER sheets are a standard size, and the Trim Line is merely a guide for trimming *reproductions* for presentation, not the original sheets. Do not "start" pens on the edges of the mylar beyond the Trim Line with the idea that the edges will later be trimmed off. Since the edges will remain, any such marks would have to be removed before a drawing will be accepted for transmittal.

Oversized Sheets. There will be cases where oversized drawing sheets of specific vessels should be made and preserved due to considerations of scale, the needs of a cosponsor, etc. Oversize drawings will not be

accepted to the HAER collection, but may be filed at the Library of Congress as part of a separate supplementary collection and cross-indexed to the HAER material. Reduced or "cut up" versions of oversize drawings inserted into standard HAER sheets are all that the HAER collection will accept.

INKS AND DRAWING MEDIA

Inks. On final drawings, only permanent, waterproof, black acetate inks (carbon particle based ones especially for drawing on drafting film) should be used, such as Pelikan-TJ or Pentel7 "Ceran-O-Matic" inks. They should never be diluted for use, because diluted ink lines do not reproduce photographically. Color is never used because of the costs of reproduction and assurance of accuracy. Pencil is discouraged because it smudges during drafting and handling. Also pencil drawings tend not to reproduce photographically or electrostatically as well as ink drawings do, primarily because a consistent width and density of pencil line is much harder to maintain.

Adhesive-backed Products. Adhesive- backed ("dry transfer") lettering and rendering materials such as Letratone7 and Kroy7 are *prohibited* on original drawings submitted to HAER because their adhesives are not archivally stable. There were numerous cases at HAER in the 1970s where dry-transfer lettering and other media flaked or peeled off mylar sheets before the drawings could even be processed for transmittal to the collection. Drawings may be made using such materials under compelling circumstances, *but only a reproducible mylar copy may be submitted as an original drawing.* Such reproducibles must be made by a photographic, not a diazo (blueprint), process for image permanence and quality. Good electrostatic or laser-printed copies on mylar are acceptable if line quality is clear and image does not flake off. Poor reproducibles will not be accepted.

DRAFTING EQUIPMENT

Projects operated by the HAER office usually require the drafting equipment listed below. Most of this equipment is widely available and would be needed by anyone producing measured drawings of a vessel by hand (rather than by CAD).

Drafting table

Parallel bar or drafting machine

12" architects' and engineers' scales

Calculator (with trigonometric functions)

Triangles, ranging from 3" to 12" sizes, in both 30°/60° and 45°/45°

Adjustable Triangles, in 8" and 12" sizes

Protractors

Ames lettering guides

Templates with graduated sizes of circles, ellipses, or specialized shapes

French curves

Ship curves

Adjustable curves or splines (36" or longer recommended)

Bow compasses

Beam compasses

Universal compass adapter (for using pencils and pens with various compasses)

Drafting lead holders and graphite leads (2H to 9H hardness) for preliminary drawings only

Lead pointers

Technical pens (for ink) in the following sizes (These pen sizes vary slightly among manufacturers):

Ink for drafting film (black)

Erasers (vinyl or plastic for both vellum and mylar)

Erasing shields

Drafting tape

Table brushes

"X-Acto" knife and blades (or equivalent)

4.6.6 Measured Drawings

Mechanical lettering set (K&E "Leroy" or equivalent)

Roll of polyester film or drafting vellum

HAER polyester drawing sheets

Use of Splines and Ship Curves. The variety of sweeping curves characteristic of vessels are usually drawn by plotting a series of points from field measurements and then connecting them--or fairing them in--with a ship curve or spline. Ship curves are rigid templates which come in a variety of curvatures and may be used in many combinations to fair in a series of points. A spline can be bent to adjust to an infinite variety of curves. Older splines were held in place by a series of weights or "ducks"; some more recent products are made of a series of interlocking strips or a malleable material that will hold a shape when bent. (Some products hold shape better than others.) When fairing in points, you will often find that not all the points can be intersected without interrupting a smooth curve. In such cases, you will have to decide if a point is to be ignored because its misplacement is obvious, or whether a more average course needs to be steered through the points to be connected.

Sample Line Weights

6x0	(0.13mm, 0.005 in)*	—
4x0	(0.18mm, 0.007 in)	—
3x0	(0.25mm, 0.010 in)	—
2x0	(0.30mm, 0.012 in)	—
0	(0.35mm, 0.014 in)	—
1	(0.50mm, 0.020 in)	—
2	(0.60mm, 0.024 in)	—
2-1/2	(0.70mm, 0.028 in)	—
3	(0.80mm, 0.031 in)	—
4	(1.20mm, 0.047 in)	—

**rarely used*

Shipment of Drawings. Drawings should always be rolled for shipment, NEVER folded. If inked drawings and pencil sketches cannot be

returned personally to the HAER office by one of the office staff or a field team member, they should be mailed via registered mail in a sealed cardboard tube with walls at least 3/16" thick to avoid being crushed in handling.

LINWORK ON FINAL DRAWINGS

General Remarks. High-quality drafting is essential. HAER drawings should be free of defects such as overrun or incomplete corners, mismatched meetings of curves and tangents, unfair curves, blobby or sloppy lines, irregularly spaced crosshatching, inconsistencies in repeated or concentric features, and poorly executed lettering. An extremely wide variety of templates and drafting aids are available and help considerably in doing good work. HAER suggests that you make your own templates for specialized features that are frequently repeated (an "X-acto" knife or needle files are usually all you need, in addition to the template plastic).

Specific requirements and recommendations for line weights will follow as drawing content and compositional elements are covered. In general, a wide variety of line weights should be used to create a rich, bold appearance. This not only results in good quality graphics, it can be essential to the reproducibility and usefulness of a drawing. HAER drawings are rarely reproduced full size; they are often reduced to 8" x 10" or smaller for publication purposes. At this size, drawings that are too delicate or timid will lose detail. Drawings should never be made with only a single line weight; such drawings not only look dull, they can be very difficult for a user to read, because they have very little sense of visual organization; figure-ground effects can create frustrating confusion. Varying line weights are a method of pointing out relative significance of features (Standard I). By using a range of line widths a hierarchy of information is created -- overall structure and form can be easily distinguished from substructures and

details. Foreground and background can be emphasized by appropriate graduations of line weights.

Delineators should aim to produce drawings that are strong enough and complete enough to stand independently from a drawing set. Full sets of HAER drawings are rarely published, but individual sheets or views often are.

Minimum Line Width. Line widths or pen sizes smaller than 4x0 (0.18mm) are discouraged because they tend not to reduce or reproduce well. Occasionally HAER uses 6x0 (0.13mm) lines in areas of extremely fine detail--closely spaced fine lines tend to read as a heavier line, but they also tend to bleed together in reductions.

Lines Drawings. HAER suggests that a vessel's lines be drawn with a 3x0 (0.25mm) or 2x0 (0.30mm) pen, while other reference lines are drawn with a 4x0 (0.18mm) pen. This way the lines will stand out clearly against their background.

Construction Drawings. The most commonly used line weights range from 4x0 (0.18mm) to 2 (0.60mm). The finest lines are used for small details, joints, patterns, and pochés, including dimension strings and arrows. Pens such as a 2x0 (0.30mm) may be used for outlines and edges of small areas and objects, while heavier lines are used principally for major portions of structure. Sectioned members should always be outlined with a heavy line--2 (0.60mm) or 3 (0.80mm)-- depending on the drawing's scale. The 3 (0.80mm) or 4 (1.20mm) pens are used primarily for lettering. Larger pen sizes are available but are very rarely used by HAER. Examples of drawings showing a wide range of line weights appear in Section 4.7 (Drawing Examples).

Pochés and Rendering. Pochés and rendering techniques are recommended, especially for distinguishing materials in section. Stippling can also be used to create a sense of depth. The use of airbrush techniques is acceptable, though not much used by HAER. "Stick on" rendering materials are prohibited from drawings submitted to the HAER collection because of their archivally unstable adhesives. Standard pochés for materials in plan and section appear in Figs. 4.6.1 to 4.6.3 for use in HAER drawings. Techniques for shadowing, shading, and outlining are presented in Figs. 4.6.4 to 4.6.6. Conventional methods of illustrating breaks in structure and materials are shown in Fig. 4.6.7.

LETTERING and DIMENSIONING

General Remarks. Just as a hierarchy in line weights can be used to make a drawing more intelligible and informative, a system of lettering sizes and line weights can be used to distinguish various types of verbal information and their functions in a drawing. In general, large lettering and heavy line weights should be used for titling views ("Deck Plan," "Section"), small lettering should be reserved for short labels and notes appearing in the view itself. Medium-sized lettering should be used for important notes or explanatory texts. HAER standards for lettering functions, sizes, and line weights are illustrated in Fig. 4.6.8. More sophisticated lettering systems can be developed through using different styles of lettering for different functions (see drawing samples, Section 4.6).

Hand or Mechanical Lettering? HAER accepts either hand or mechanical lettering, but prefers hand lettering as a matter of training for the student employees the program hires for most of its projects. Most hand lettering on HAER drawings is less than 1/2" high. HAER usually produces larger letters mechanically or traces them from samples. Due to its archivally unstable adhesives, transfer lettering is prohibited on drawings submitted for the HAER collection at the Library of Congress.

4.6.8 Measured Drawings

Lettering can often make or break a drawing visually. Poor lettering is distracting and may unfairly reflect on the quality of your documentation. If you cannot letter well by hand, HAER strongly recommends that you improve your technique or use a mechanical lettering system. *Mechanical lettering must be used in HAER sheet title blocks.* See Fig. 4.6.11 for further instructions.

Lettering Styles. Sans-serif block lettering, whether vertical or inclined, is preferred for all purposes where lettering is smaller than 1/2". Italic forms and typeface styles are usually reserved for larger lettering on title pages or in sheet headings, though a careful mixture of styles can be used in the notes and labels on a drawing to aid legibility and esthetics. CAD systems can apply a wide variety of typefaces to drawings; serif and sans serif letters such as Univers or Times Roman, or similar block letters are most readable. Ornamented or advertising faces are discouraged except for title page titles.

While HAER encourages the use of hand lettering, this does not mean all hand lettering styles are acceptable for use. Legibility and uniformity in lettering are paramount, especially on reduced copies of drawings, and for this reason an unembellished block lettering style is much preferred. Individualized styles characterized by exaggerated forms and stylistic aberrations are excluded, generally because they are difficult to read and do not reduce well. Some examples of unacceptable and acceptable styles are given in Figs. 4.6.9 and 4.6.10. All upper-case lettering or mixed upper-and-lower-case lettering is acceptable, provided that one or the other format is used consistently throughout a drawing set. All lettering in a drawing set should be done by a single person, or by team members whose lettering styles are very similar in order to maintain a uniform appearance. Where a lot of lettering must be done, there may be good reason to use a mechanical lettering system, since this allows all team members to letter in a uniform style and avoids burdening one or two individuals with the job.

Before doing any lettering (whether by hand or mechanically) it is extremely helpful to make up sheetfuls of lettering guide lines for the various letter sizes and line spacings you will be using. All you have to do after planning your layout is slide a guide sheet under the draft sheet or final mylar and letter away. These sheets will save a lot of time over repeatedly constructing and erasing individual sets of guide lines for every label and blurb. If an up-to-date copy machine is available, you may only have to draw one set of lines: the various other sizes and copies can be made by the machine. If guide lines are pencilled onto the mylar, they must be erased before reproducing the drawings, and frequently erasure thins out ink lines in some places. This danger can be avoided by pencilling on the back of the mylar, but guide sheets will still save you the time and trouble.

Dimensioning. Sizes and weights of numerals follow the same rules as lettering, though in most cases dimensions need not use numerals higher than the minimum 5/32 inch height for HAER work. The format for laying out dimension strings and dimensions for HAER is illustrated in Figs. 4.6.12 to 4.6.14. HAER drawings are not working drawings, hence there is no need to dimension everything down to the smallest detail. Principal overall dimensions and those of major features are all that are usually called for (see drawing samples in Section 4.6).

English and Metric Systems. Though the English system of linear measure is more widely used than the metric system in the United States, metric figures are required along with English figures for principal overall dimensions. Metric figures should be enclosed in parentheses, and rounded to the nearest 0.01 meter. There is no requirement to show metric equivalents of English figures for tonnage, volumes, sail areas, etc., but their inclusion may be helpful to future researchers, assuming that the metric system becomes more widely established.

Graphic Scales. In addition to dimensions, all drawings should contain a graphic scale in the

format illustrated in Fig. 4.6.15. This format is based on traditional maritime scales, which have been used by numerous authorities. Such a scale permits the scaling of reduced copies of drawings, and it should be as long as is practical on the drawing sheet. A less prominent metric scale is included to permit use of the metric system by those more accustomed to it.

CAD Drawings. Computer-aided drafting has become more commonplace and HAER has developed some guidelines to assist in the production of drawings developed by this method. Generally, HAER follows the guidelines established by the American Institute of Architects as published in their manual “Architectural Graphic Standards” published by John Wiley & Sons, Inc.

The HABS/HAER/HALS guidelines for CAD drawings are included at the end of this chapter.

Digital copies of the HAER title block, complete with Layers and other preferred formats for fonts, dimension lines, etc. are available on the HAER website or by contacting the HAER office.

EXAMPLES

The following figure pages illustrate the various recommendations for the production of HAER drawings.

Materials in Plan or Profile

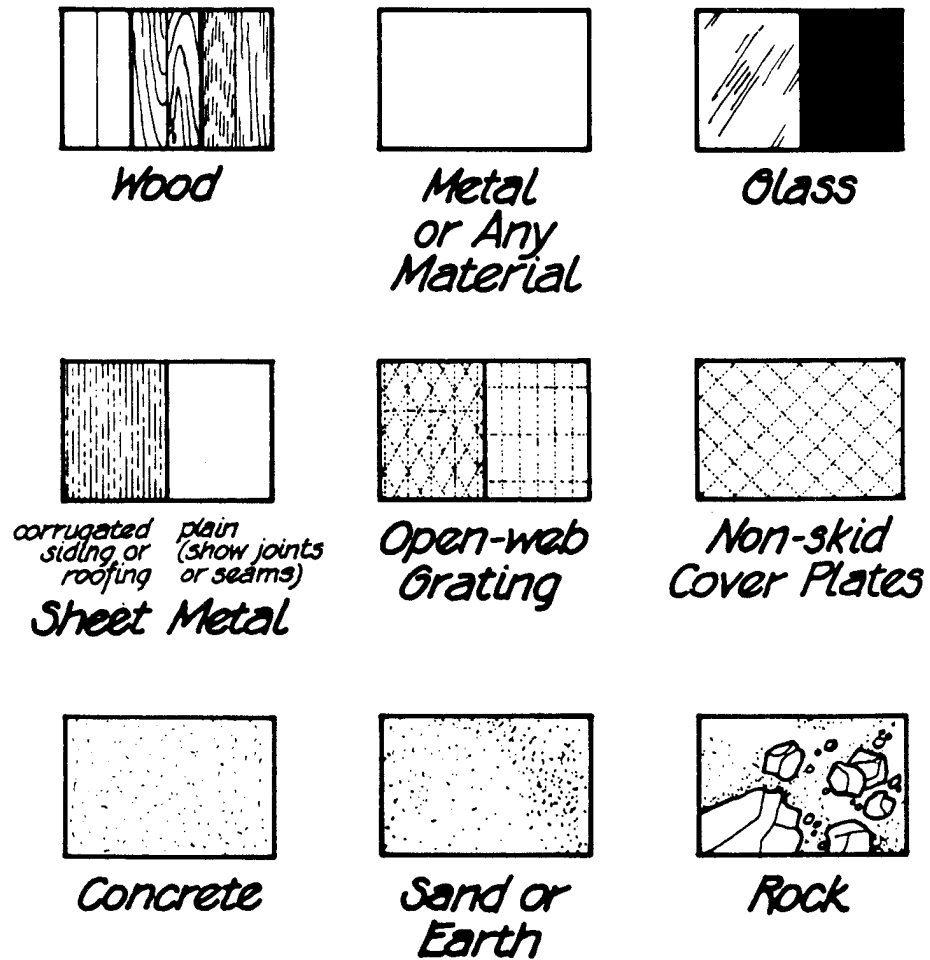
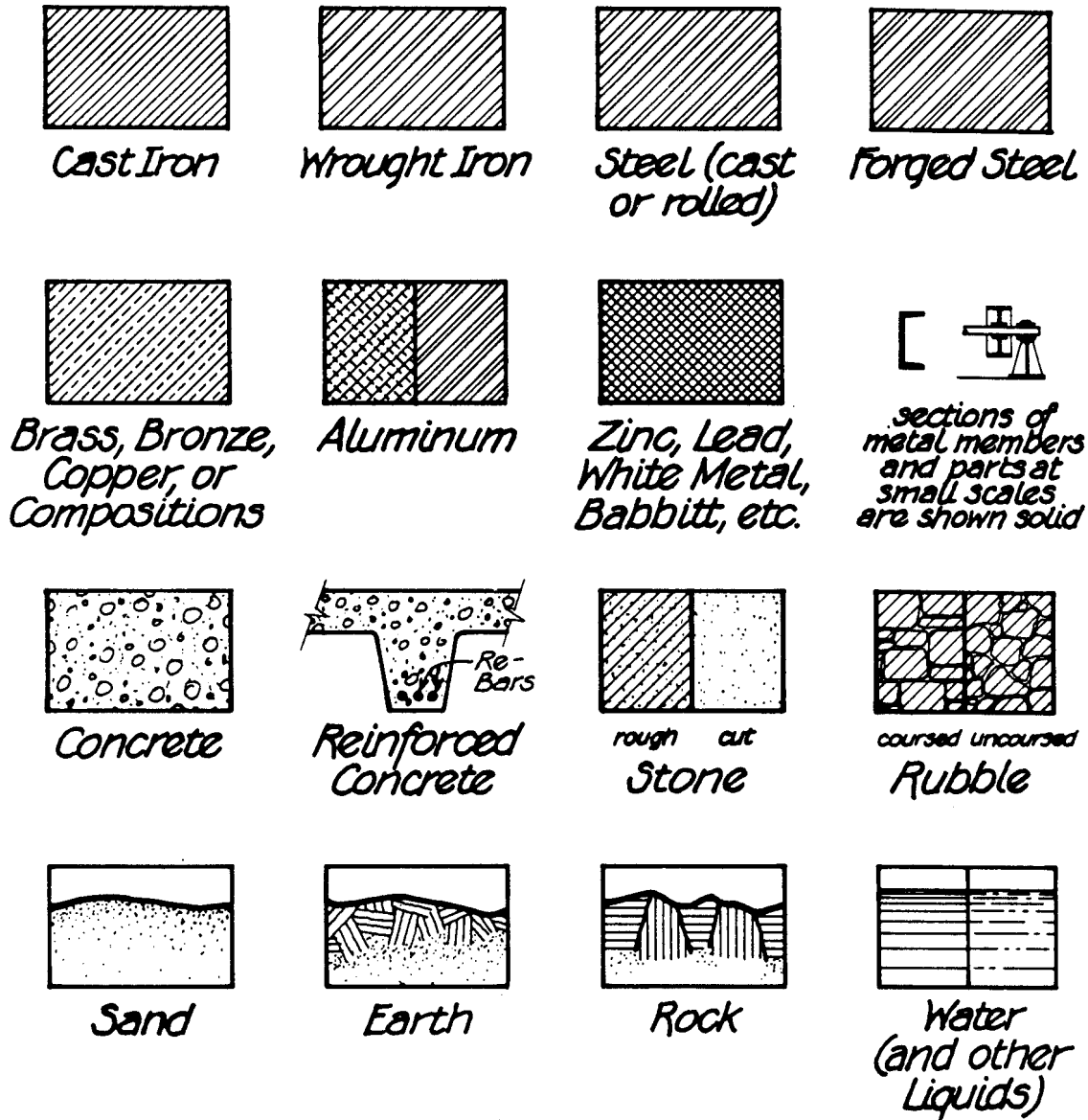

Fig. 4.6.1

Materials in Section (Standard Symbols)



(Continued)

Fig. 4.6.2

Materials in Section (Standard Symbols)

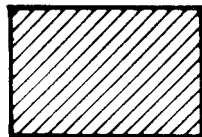

*Common
Brick*

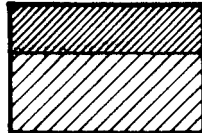

*Common Brick
with Facing
Brick*

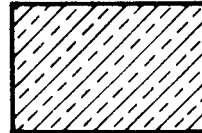

*Fire Brick or
Refractory
Materials*

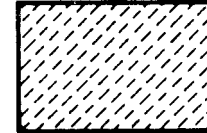

*Glass,
Porcelain,
Marble*



Wood (along grain)

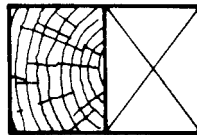

*Wood
(crossgrain)*

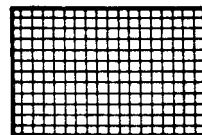

*Electric
Windings.
(Generator
Coils, etc.)*

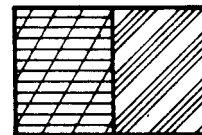

*Electric
Insulation*

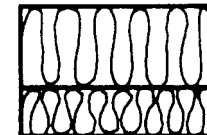

*Thermal
Insulation*

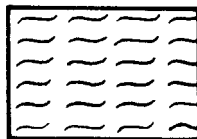

*Flexible
Materials
(Rubber,
Leather, etc.)*



*Any
Material*



*Any
Material
(used where graphics
or clarity would benefit,
e.g. walls in plan or
section, building or
machinery structure,
etc.)*

Fig. 4.6.3

Shadowing

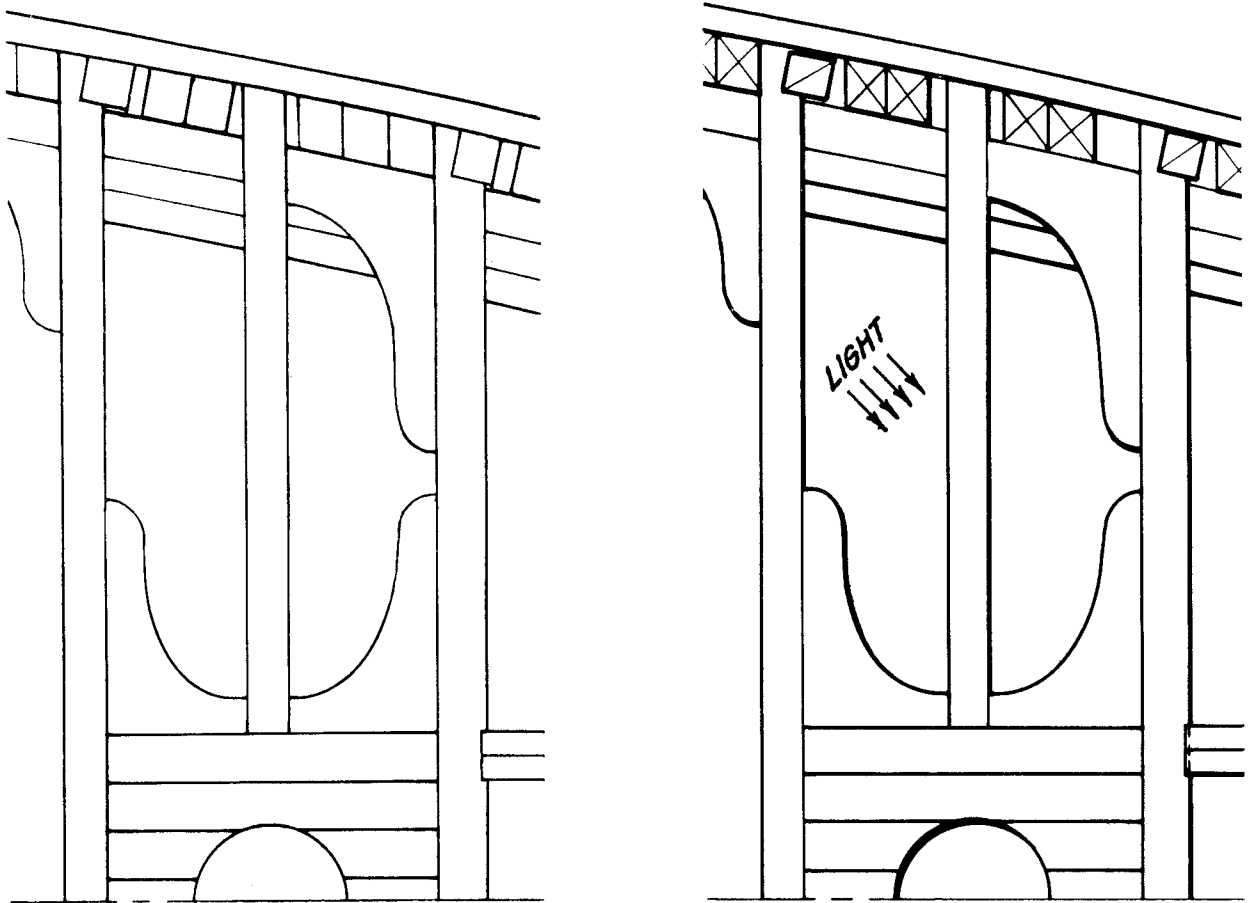

Fig. 4.6.4

Line shadowing is an old engineering drawing convention which gives drawings a very readable three-dimensional quality. Compare "with" and "without" views shown here of a foredeck construction plan. The line-shadowed convention *always* assumes light is shining from the *upper left* of the drawing (held so the labels are "right-

would cast shadows are inked in heavier lines (#2 pen or larger) than those which are directly illuminated. Shadows must be "feathered" on rounded features. The somewhat antique flavor of this technique seems appropriate for historical structures and invites attention. Use of shadowing is not required, it is strongly recommended if outlining techniques are not used.

Outlining

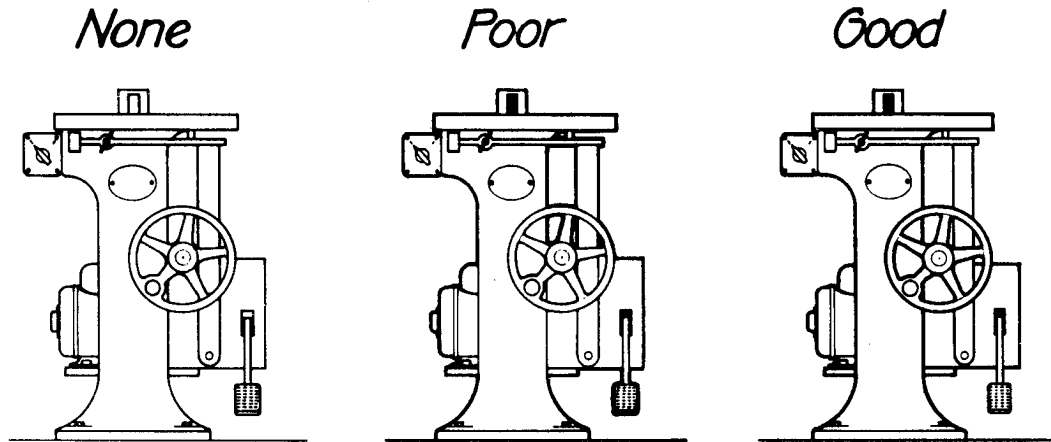

Fig. 4.6.5

Outlining is a more contemporary technique than line shadowing for giving a three-dimensional aspect to a drawing. It creates a "depth effect" by surrounding features with heavier (or lighter) lines in order to make features stand out from (or fall back into) the drawing plane.

Though the above object is not a vessel, the use and misuse of outlining are easily illustrated by it. Views without outlining tend to look "flat" and may introduce confusing figure-ground effects (above left). Outlining is commonly understood to mean emphasizing only the extreme edges and open spaces of an object (above center), a half-baked approach that leads to confusing effects as well. The handwheel in the center example looks awkward because only those parts which have "nothing" behind them have been outlined. The inconsistent emphasis makes the wheel

appear to be in different planes at the same time. The foot pedal is also much too heavily emphasized for its relative size.

It is better to outline individually the separate components of an object or those parts of it which lie in different planes. As a rule, the most emphasis should be given to the largest, most important or defining parts or to those parts which lie in the foreground. In the case of the machine on the above right, the handwheel, table top, motor, and pedestal are all outlined as discrete components. Less dominating parts receive less emphasis, while details such as the switch and motor parts receive none at all. The overall drawing is much more readable and consistent in its graphic logic.

Similar rules apply to isometric and perspective drawings.

Shading

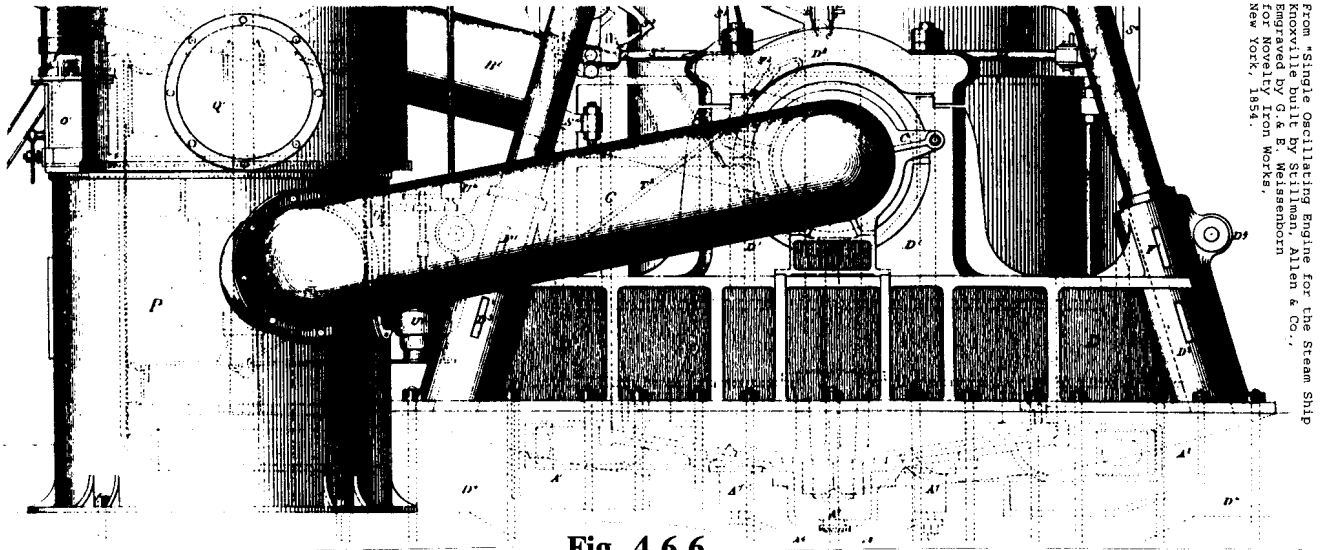

From "Single Oscillating Engine for the Steam Ship
Known as the 'Sigsbee' built by Sigsbee, Allen & Co.,
New York, 1854."
Copyrighted by Sigsbee, Allen & Co.,
New York, 1854.

Fig. 4.6.6

Like line shadowing, shading is an old engineering drawing convention, but one used to express the "roundness" of mechanical parts such as pipes, tanks, shafts, castings, etc. Care should be taken

not to use it on features where it might be confused for structure, such as barrels composed of staves. It lends an antique look that works very well graphically, but it is chiefly used for machinery.

Conventional Breaks

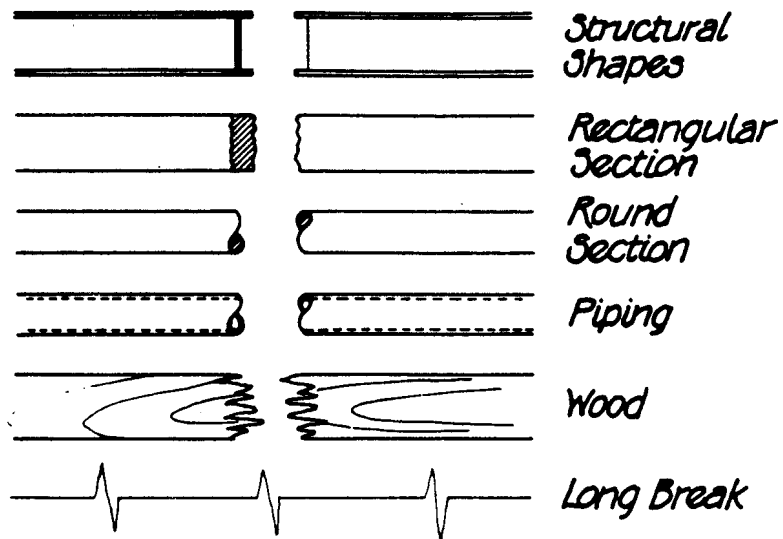

Fig. 4.6.7

Lettering Sizes and Pen Weights

All drawing titles (e.g. "PLAN," "SECTION," etc.) to be a

**MAXIMUM $\frac{3}{8}$ " HEIGHT,
#4 PEN**

MINIMUM $\frac{1}{4}$ " HEIGHT, #3 PEN

All blurbs and texts to be a

**MAXIMUM $\frac{1}{4}$ " HEIGHT, #3 PEN
MINIMUM $\frac{3}{16}$ " HEIGHT, #2 PEN**

All notes and labels to be a

**MAXIMUM $\frac{3}{16}$ " HEIGHT, #2½ PEN
MINIMUM $\frac{1}{8}$ " HEIGHT, #0 PEN**

All dimensions

**NO SMALLER THAN $\frac{5}{32}$ " HEIGHT, #1 PEN
EXCEPT FOR NUMERALS IN FRACTIONS
WHICH SHOULD BE NO SMALLER THAN
THAN $\frac{1}{8}$ " HEIGHT, #1 PEN**

**ABSOLUTELY NOTHING LESS THAN $\frac{1}{8}$ "
HIGH OR LIGHTER THAN #0 IS
ACCEPTABLE BECAUSE IT IS
EXTREMELY DIFFICULT TO READ
WHEN REDUCED TO LESS THAN
 $\frac{1}{4}$ FULL SIZE!**

*Below is this
page reduced
to approximately
 $\frac{1}{4}$ full size* ↓

Measured Drawings 4.6.17

Lettering Sizes and Pen Weights

All drawing titles (e.g. "PLAN" "SECTION" etc.) to be a
**MAXIMUM $\frac{3}{8}$ " HEIGHT,
#4 PEN
MINIMUM $\frac{1}{4}$ " HEIGHT, #3 PEN**

All blurbs and texts to be a
**MAXIMUM $\frac{1}{4}$ " HEIGHT, #3 PEN
MINIMUM $\frac{3}{16}$ " HEIGHT, #2 PEN**

All notes and labels to be a
**MAXIMUM $\frac{3}{16}$ " HEIGHT, #2½ PEN
MINIMUM $\frac{1}{8}$ " HEIGHT, #0 PEN**

All dimensions
**NO SMALLER THAN $\frac{5}{32}$ " HEIGHT, #1 PEN
EXCEPT FOR NUMERALS IN FRACTIONS
WHICH SHOULD BE NO SMALLER THAN
THAN $\frac{1}{8}$ " HEIGHT, #1 PEN**

**ABSOLUTELY NOTHING LESS THAN $\frac{1}{8}$ "
HIGH OR LIGHTER THAN #0 IS
ACCEPTABLE BECAUSE IT IS
EXTREMELY DIFFICULT TO READ
WHEN REDUCED TO LESS THAN
 $\frac{1}{4}$ FULL SIZE!**

Fig. 4.6.8

Fig. 4.6.8

Hand Lettering

Unacceptable Styles

Lettering that is too stylized, elongated, or badly formed falls into the "unacceptable" category. Such lettering does not reduce well and is not very legible to the general public:

THE LAND THAT FORMED THE HACIENDA
HE WAS A SPANISH EMIGRE FROM VENEZUELA,
HIS VENEZUELAN-BORN SON, DON
1845, AND SUBSEQUENTLY FOUNDED THE

Too vertically elongated; middle horizontals too high.

THIS RECORDING PROJECT
HSE PROGRAM OF THE HISTORIC
RECORD (HAER) TO DOCUMENT
INDUSTRIAL SITES THROUGHOUT
WAS CONDUCTED BY HAER PLANS

S, O, R, P, and Ns too compressed; blur when reduced.

1 FREIGHT SHOP
2 TRUCK SHOP
3 MATCHING ROOM
4 HAMMER SHOP
5 WATER TOWER
6 GEN'L STORE NO
7 HOT AIR DRY
HOUSES (KILNS)
8 OIL HOUSE
9 IRON WAREHOUSE
10 REAR ERECTING
SHOP
11 REAR ERECTING
SHOP
12 REAR ERECTING
SHOP

Very eccentric; hard to read; much too elongated vertically. U, O, A, R, P, H, N, and W will all fill in and become blobs when reduced.

FIRST FLOOR PLAN *Just plain sloppy!*

Fig. 4.6.9

Hand Lettering

Acceptable Styles

Acceptable styles have well-rounded letters free of stylistic exaggerations. They read easily, are adequately spaced, and reduce to 1/4 size without blurring. Block, inclined, and lower case lettering are acceptable subject to these conditions.

ESTABLISHED IN 1854, THE EM
CHASED THE MILLS IN 1862
1875 TO 1890 THIS WAS THE

RECENT OWNERS HAVE
ENGINE ORDERED FROM
SUGAR FACTORY AND IS

THE FIELD WORK, MEAS
DIRECTION OF DOUGLAS
DIRECTOR. THE SURVEY

THE SURVEY WAS COSP
CITY OF LOWELL THROU
ON MERRIMACK RIVER.

THE FIELD WORK, ME
1974 AND 1975 BY TH
HISTORIAN. FIELD PE

*This Recording and
range program to d
historically significa*

AT THE SMALL VILLAGE
WORKS AFTER THE
SMALL BLAST FURN

—+ } minimum:
 1/2 letter height
 } maximum:
 1 letter height

Labels and blurbs should be laid out in pencil before inking to check letter spacing, spelling, hyphenation, and visual effect on drawing composition.

Fig. 4.6.10

Title Blocks

All lettering in title blocks must be done with Leroy or Unitech equipment. No hand lettering or presstype!

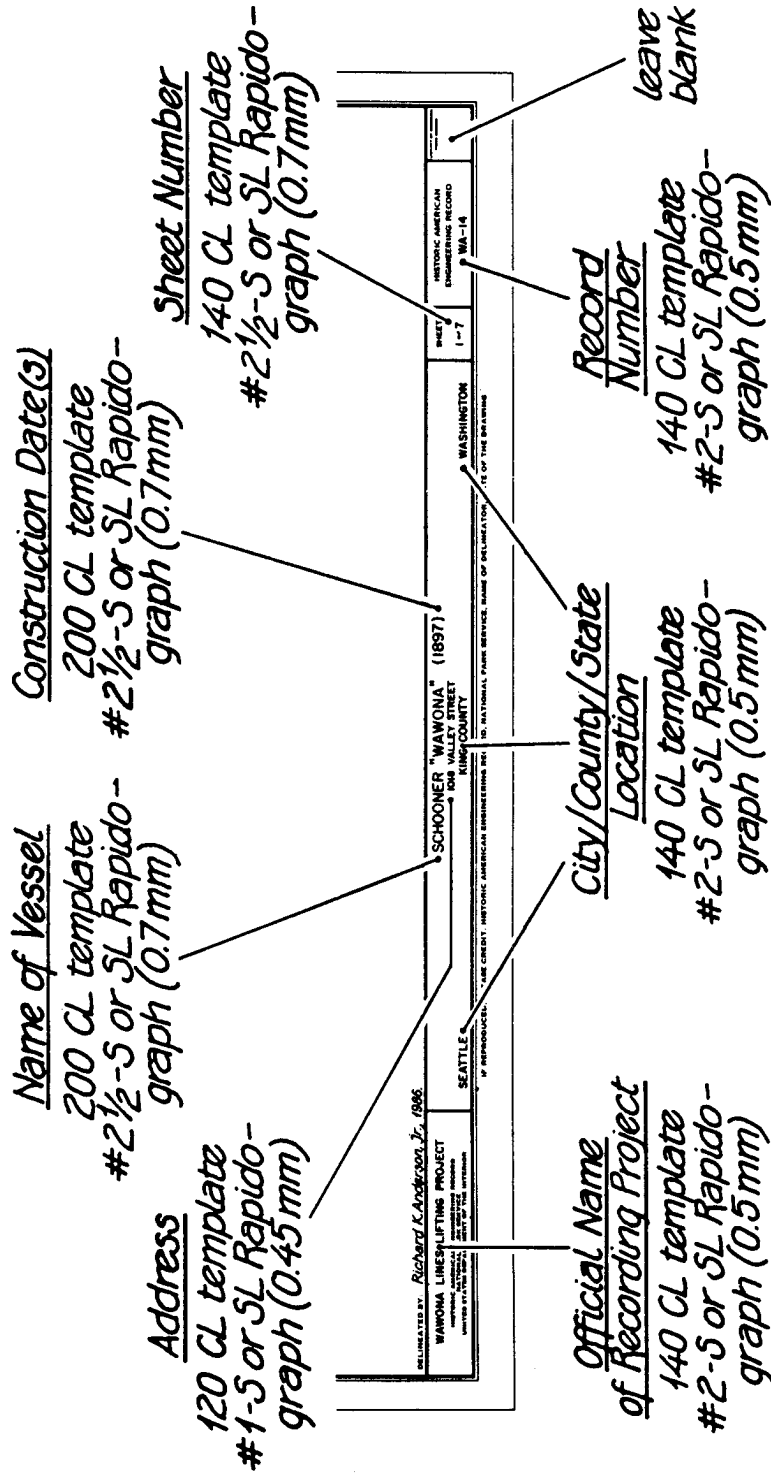

(Continued)

Fig. 4.6.11

Title Blocks

LEFT CORNER BLOCK: The official name of the recording project, such as SHIP BALCLUTHA RECORDING PROJECT is to be lettered here in capital letters.

NAME OF VESSEL: The original name is required here. In some cases, this name will not be readily evident, and careful research will be needed to determine it. Later or more common name(s) may be added in parentheses, e.g. SHIP "BALCLUTHA" (STAR OF ALASKA). If the original name cannot be determined, then a later or current name should be substituted.

DATE: The year of the vessel's construction should follow the name on the same line, set off by two spaces. No additional dates are needed.

ADDRESS: Though some vessels can and will often move from the place they are recorded, the location where a vessel is recorded should be determined as sensibly as possible. Vessels owned by museums of other organizations may be located simply by the organization's street address. The address of a privately owned vessel should be where the vessel is located, *not* that of the owner, unless these places are the same. Otherwise, names of water bodies, prominent geographic landmarks, towns, or major roads should be used.

LOCATION: The geographic location where a vessel is recorded should be established by city (village, town, etc.), county, and state from reliable map sources, even if the vessel is destroyed after documentation. Townships or other local governmental designations should be included where applicable. Vessels in rural areas (abandoned on a beach, for example) should be located as in the vicinity of the nearest settlement having a post office, e.g. "Solomons vicinity, Calvert County, Maryland". No county name is given for independent cities, e.g. "Richmond, Independent City, Virginia".

ALL OF THE ABOVE INFORMATION MUST APPEAR ON THE COVERS OF ALL FIELD NOTEBOOKS.

RECORD NUMBER: This number is assigned by the HAER Washington office or National Park Service regional office. If you do not receive it, leave this space blank. It will be filled in later by the National Park Service.

LIBRARY OF CONGRESS NUMBER: Leave this space blank. It will be filled in by the Library of Congress.

TITLE BLOCKS MUST BE THE SAME ON ALL SHEETS WITH THE SAME HAER NUMBER

(no subtitles, such as "Plan" or "Section" are permitted)

Dimensioning

1. Use either a 3x0 (0.25mm) or 4x0 (0.18mm) pen for dimension strings:

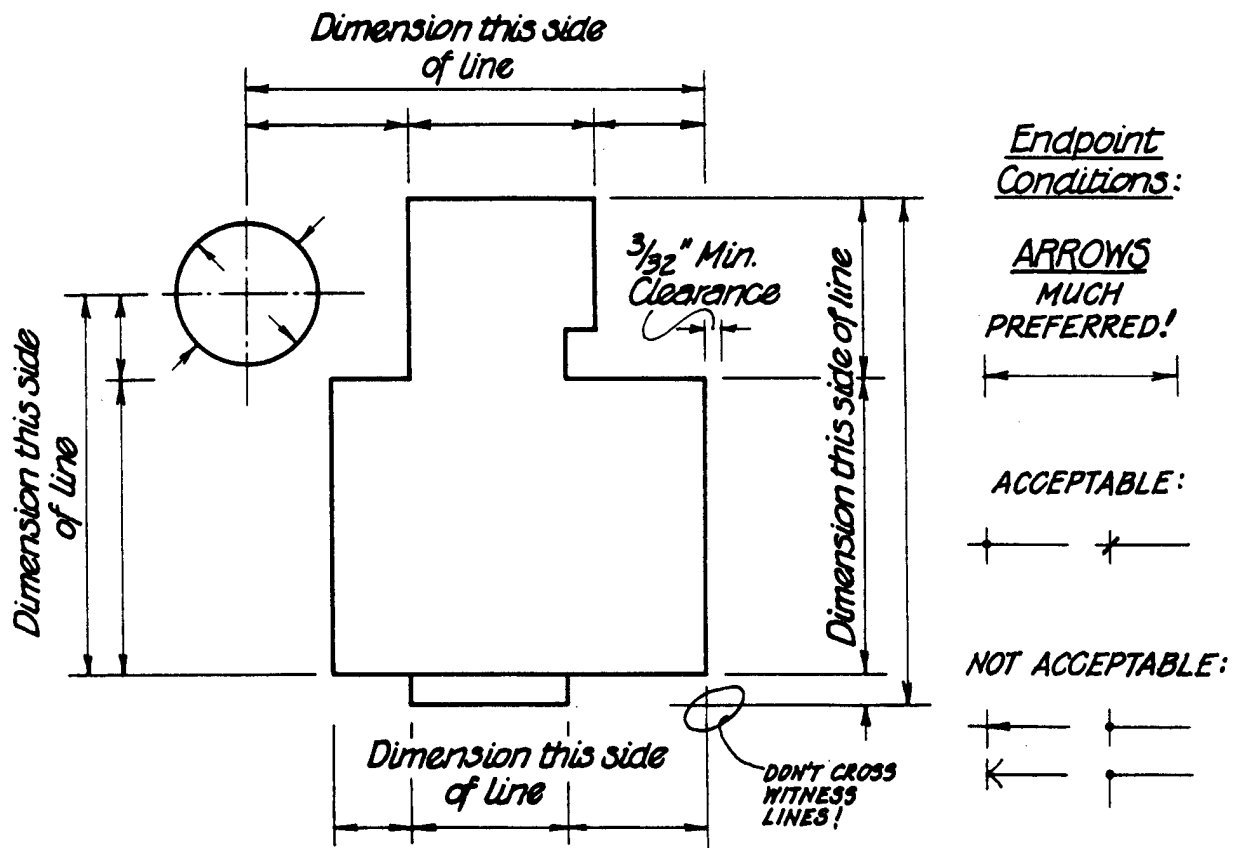

2. Numerals should be a *minimum* of $5/32$ " in height, except for fractions, whose numerals may be no smaller than $1/8$ " high.
3. When putting metric measurements alongside English ones, place parentheses around the metric figures, e.g. 12'-0" (3.66M). *Always* round metric figures to the *nearest 0.01 meter!*

Fig. 4.6.12

4. Don't dimension across linework! It impairs legibility.

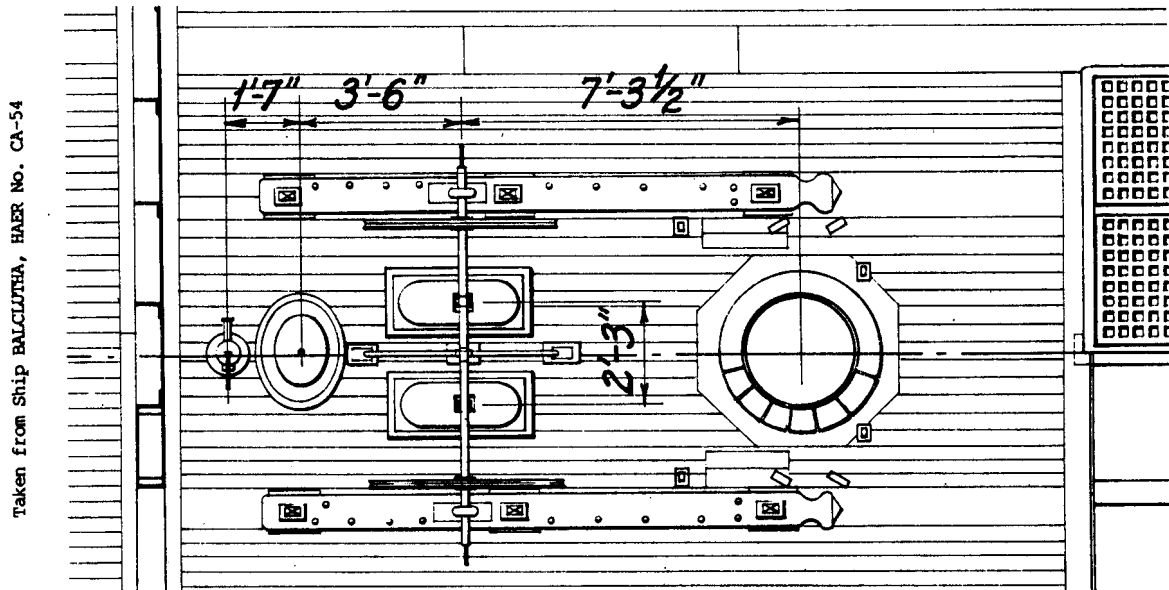

Fig. 4.6.13

5. Put dimensions outside of linework, or where there is no alternative, erase linework for clarity.

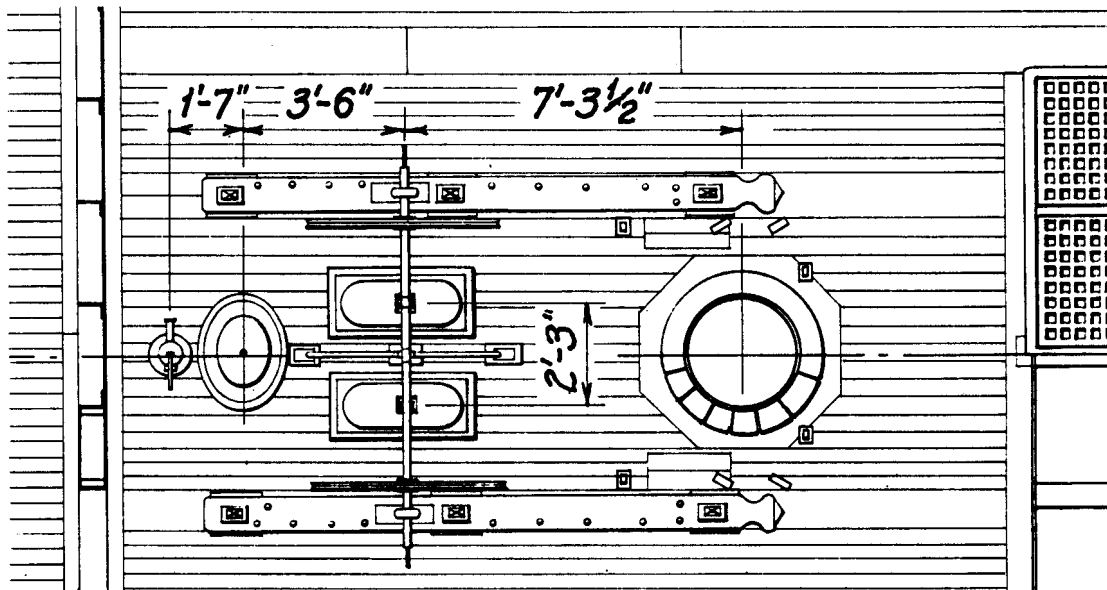

Fig. 4.6.14

Graphic Scale

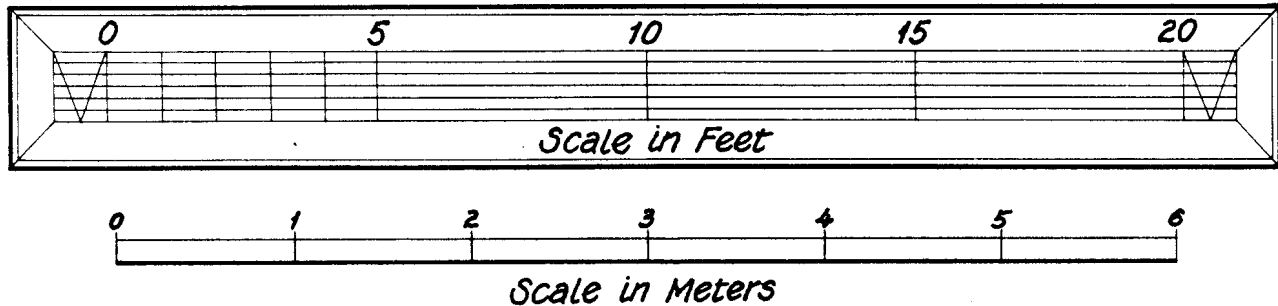

Fig. 4.6.15

The type of graphic scale shown above (reduced) is adapted from a style widely used by marine draftsmen and recorders until the early 20th century. Since it seems to have acquired the status of a

standard and is very useful for scaling enlarged or reduced copies, HAER sees no need to introduce any new standard. The only addition made is a metric scale below the English one.

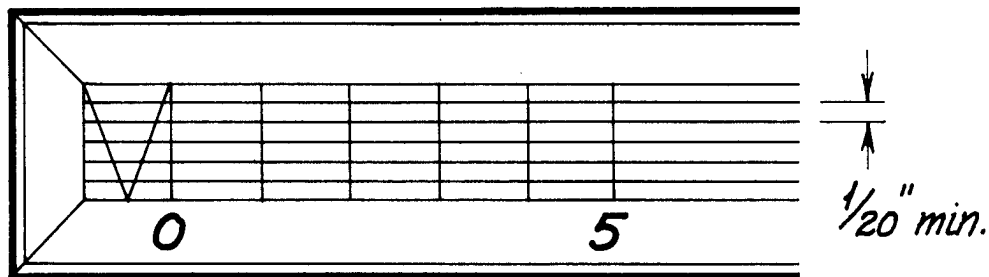

Fig. 4.6.16

To produce this type of scale, seven evenly spaced parallel lines are drawn for the English scale, and then marked off in 1-, 5-, or 10-scale-foot intervals. When a scale foot is divided by the "V" figure seen above, the diagonal lines intersect the horizontal lines at twelfths of a foot (inches). The metric scale need only be a marked off in 1- or 5-meter intervals.

HAER strongly recommends that scales be drawn the full width of the view the scale accompanies (profile, plan or section) for greater ease and accuracy in marking and using reproductions of drawings (see Drawing Examples, Section 4.7). Short scales introduce larger scaling errors than long ones. Note that the subdivided foot interval is to the *left* of the zero point.

DRAWING ELEMENTS & COMPOSITION

General Remarks. Laying out and composing a drawing is more than merely stuffing a subject between the borders somehow, and sandwiching in notes, labels, or scales as fancy strikes. Careful planning of a set of drawings is also much more than an exercise in "frilly" esthetics. A drawing is intended to store and communicate information, and the better it does this, the more useful and successful it is. Drawings are necessarily selective and interpretive about the facts they present, and where organizational and esthetic considerations have been used to further communication, the results are highly useful as well as elegant in appearance. Planning a drawing set involves numerous elements, of which major ones will be discussed in this section and illustrated by example in Section 4.6. Elements are such things as linework, titles, blocks of notes, dimensioning, etc., all of which must be considered and harmoniously combined. (Even empty space needs to be considered as a sheet design element.) Organization, clarity, and consistency are your guiding principles. The idea is to help a user see relationships, not only among the vessel's parts, but also between the vessel and any important historical, technical, or archeological information your project brings together.

Organization. You need to document important information about your vessel. How can your drawing set accomplish this? Is the set designed to take a reader through the vessel in an orderly progression? You may elect to use more than one HAER sheet to record a deck plan or inboard profile; are the drawings laid out in such a way that a future user can combine them with a minimum of effort? Is each sheet organized in such a way that a user can grasp the major elements right away--linework, notes, dimension, a scale, a drawing label, etc.? Are historical notes easy to find?

Clarity. Clarity results not only from good organization, it also involves good delineation, and a thoughtful sheet layout quickly and clearly communicates its information to the user. Will

the user's eye be drawn to the important facts you are documenting by appropriate positioning, delineation, or labeling, or will he have to "dig" for help? Are important notes made in teeny cramped lettering and hidden in a corner, or are they prominent and positioned near the features they discuss? Did you use arrows to clearly and unambiguously point to parts you labeled? Does the drawing of the vessel "read" (strong graphics), or is it uninteresting because it is drawn entirely with a 3x0 pen? Did you provide a visual key on each sheet to show a user what part of the vessel he is looking at? Is the key in the same relative place on every sheet? Is the scale of the drawing appropriate to what is significant to show? Did you title the views boldly and clearly, or use a tiny letter size and a timid pen weight? Did you provide principal dimensions and label important parts? Is vital historical information present? Can the user easily find this sort of information without hunting among other sorts of verbal communication, or did you just letter everything in the same letter size and weight? Did you key in parts of the historical report or selected photographs for the user to consult when this would be helpful? Did you remember not to label across linework so the labels can be clearly read?

Consistency. Treating the same type of information the same way sheet to sheet allows a user to more easily see what is *different* from sheet to sheet. It permits him to study the vessel without being distracted by important, but secondary, background information. Repeated elements, such as titles, graphic scales, blocks of notes, should be located in the same relative positions on every sheet--in other words, you should always be able to find the sheet title in the lower right hand corner. (The lower left corner, or the bottom center are also acceptable places, but it's the consistency, not the position, that's important here.) Graphic scales should use a consistent format. Notes should be made in a consistent letter size and pen weight from sheet to sheet, as distinguished from sheet titles, which should have their own consistent size and weight.

Review. On HAER projects, ongoing review of drawings in the field is carried out by the field team supervisor. Review of drawings is also performed by the project manager during periodic visits, as well as by a review team of specialists. Where a timely visit by a project manager is not feasible, copies of preliminary drawing sheets should always be sent to the HAER office for review and comment, especially before final drawings are inked.

The following pages constitute a sort of checklist for you to use as you plan and complete your drawings. Basic elements will be considered first, and the composition of title pages, lines, and construction drawings later.

ELEMENTS

Scale. Choice of scale to which a vessel will be drawn depends on the overall size of the vessel and the amount of detail and precision warranted by her significance or required by your project's goals. A scale of 1/4" to the foot has been traditionally used for overall views (deck plans, profiles) as long as a view could be made to fit on a manageable sheet size. Scales such as 1/8", 3/8" and 1/2" to the foot have been used, and drawings 12 feet long are not unknown. However, HAER sheets are limited to standard sizes, hence the longest overall view (such as an outboard profile) that can be drawn within the borders is about 120 feet at 1/4" scale. Beyond this, either a smaller scale must be used or multiple sheets. There is no requirement to maintain a single scale throughout a drawing set, but disorientation can be kept to a minimum by at least drawing deck plans and profiles at the same scale. Midship sections are generally drawn at a scale two or three times larger than plans and profiles. Certain views for a very large vessel may have to be drawn twice: once at a small enough scale to give the reader the overall appearance on a single HAER sheet, then the same view at a larger scale broken up over several sheets to present more detailed coverage. Details should be drawn at larger scales, e.g. 1/2", 1", or 2" to the foot for 1/4" scale profiles, and 3/4",

1 1/2", or 3" to the foot for 3/8" profiles. Some types of detail, such as molding profiles of joinery, may need to be drawn full size.

Multi-sheet Views. Deck plans and other views which have to be broken up over two or more sheets can be handled a number of ways. Since vessels consist of a number of important continuous curves, there is considerable advantage to drawing a single view (such as a lines plan, deck plan, or inboard profile) in preliminary form as a single oversized drawing on a sheet cut from a roll of drawing material. A photographically reduced copy should then be made to a scale small enough to fit a single HAER sheet before cutting the larger drawing up for tracing onto HAER sheets. (The same method would apply if you are using sheets intended for other depositories.) The reduced copy is then used as a base for inking the overall view onto a HAER sheet. In some cases, an oversize final ink drawing done on roll material should be made. It may then be preserved (see Oversized Sheets on p. 4.6.5), and a same-size photocopy cut up and spliced into smaller sheets, or the original itself may be cut and spliced. If smaller sheets are to be submitted to HAER, spliced sheets will have to be photographically copied same-size (including HAER borders) onto a new sheet of mylar, since neither tape nor other splicing materials have archivally stable adhesives. Before cutting up a final drawing, however, consideration should be given to making a same-size photographic copy for use by the vessel owner, and a copy reduced enough to fit into a single HAER sheet for the overall view. The photographically reduced view can be well worth the money in terms of the time it would take your team to redraw it at a smaller scale, unless the reduction is so extreme that small details bleed together. In the latter case, the view should be redrawn and simplified at the smaller scale for increased clarity.

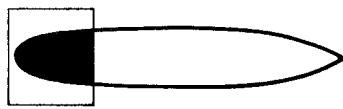
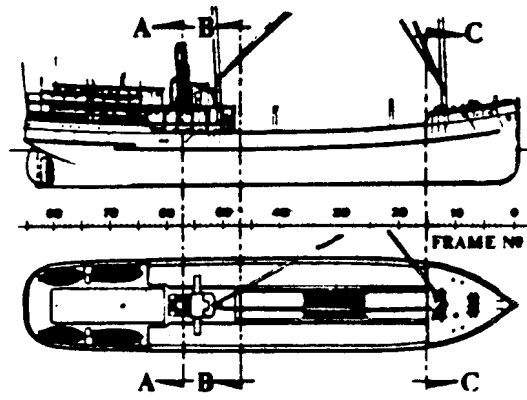

1st Sheet

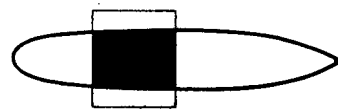

2nd Sheet



3rd Sheet

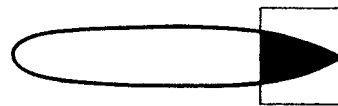

4th Sheet

Fig. 4.6.17
Location Diagrams

All reduced and same-size copies should be checked for scale distortion. Photographic copies made on drafting film with a negative and lithographic copy camera (found primarily in reprographic firms) are the most reliable. Other types of camera may distort unevenly (e.g., stretching at the ends or in corners). Electrostatic copies usually show scale distortion in the direction the drawing travels through the copying machine.

Graphic Scale. The format for the graphic scale is covered in Figs. 4.6.15 and 4.6.16, however, the scale should be located near the bottom of each sheet, and should be approximately the same length as the view it accompanies.

Sheet Titles. Every view must have a title: "Outboard Profile," "Main Deck Plan," "Section - Station 3," etc. This title should be clear and thorough, so that there is no ambiguity as to what is meant. Lettering should follow the sizes and weights given in Fig. 4.6.8. Titles may be underlined to add visual emphasis, and they should be in a prominent place on the sheet.

Diagrams. In views requiring multiple sheets, it is very convenient to include a small diagram near the sheet title showing what is being portrayed about the vessel and where (see Fig. 4.6.17). The entire vessel should be drawn schematically at a very small scale, and the portion appearing on the particular sheet emphasized by heavy lines or shading. A similar approach should be taken when drawing parts of structural or mechanical systems, so the place of each part can be shown in terms of the whole.

Blurbs, Notes, Labels, and Keys. Blurbs, notes, labels, and keys used in drawings should be composed with the assistance of the team historian. This will ensure that important information is conveyed and proper terminology used. HAER delineators are not expected to be writers who know all the ins and outs of vessel construction and terminology, but between themselves and other team members, all are responsible for seeing that verbal information in the drawings has a professional, scholarly

content and is graphically integrated into the sheet design. Specified lettering sizes and weights are given in Fig. 4.6.8.

Blurbs. In general, blurbs should be limited in length and contain only the most important facts and observations. They aren't intended to be a substitute for the historian's report in their depth. They should aid the drawing in documenting and interpreting the vessel. The longest blurb in a drawing set is likely to appear on the title sheet as a brief history of the vessel with a statement of her significance. Connected with this should be a project credit statement listing sponsoring organizations, team members, volunteers, and special acknowledgements. Operations of equipment might also be described in a blurb when such equipment is drawn.

Notes. These are generally condensed remarks consisting of a phrase or brief statement used to supplement graphic information. They may make a historical statement, describe a material or function, give pertinent information on a piece of mechanical equipment, call attention to important qualifications or field conditions, record bibliographical data, make observations, point out important speculations, or account for the accuracy of questionable-looking features in a drawing.

Label and Keys. These are essentially two different methods of citing or describing different parts of a vessel or feature of your drawing. They may be used separately or together as the graphic design or available space on a drawing require. Keys with number "tags" are most often used when the number of parts or elements to be cited within a given space is too numerous to label outright without obscuring large portions of the linework or crowding the space with verbiage. Labels are used where the number of things to be described is few and there is ample space to accommodate verbiage. Often drawings will permit labels for some things, but numerous other important elements will be too highly concentrated to label without using keys;

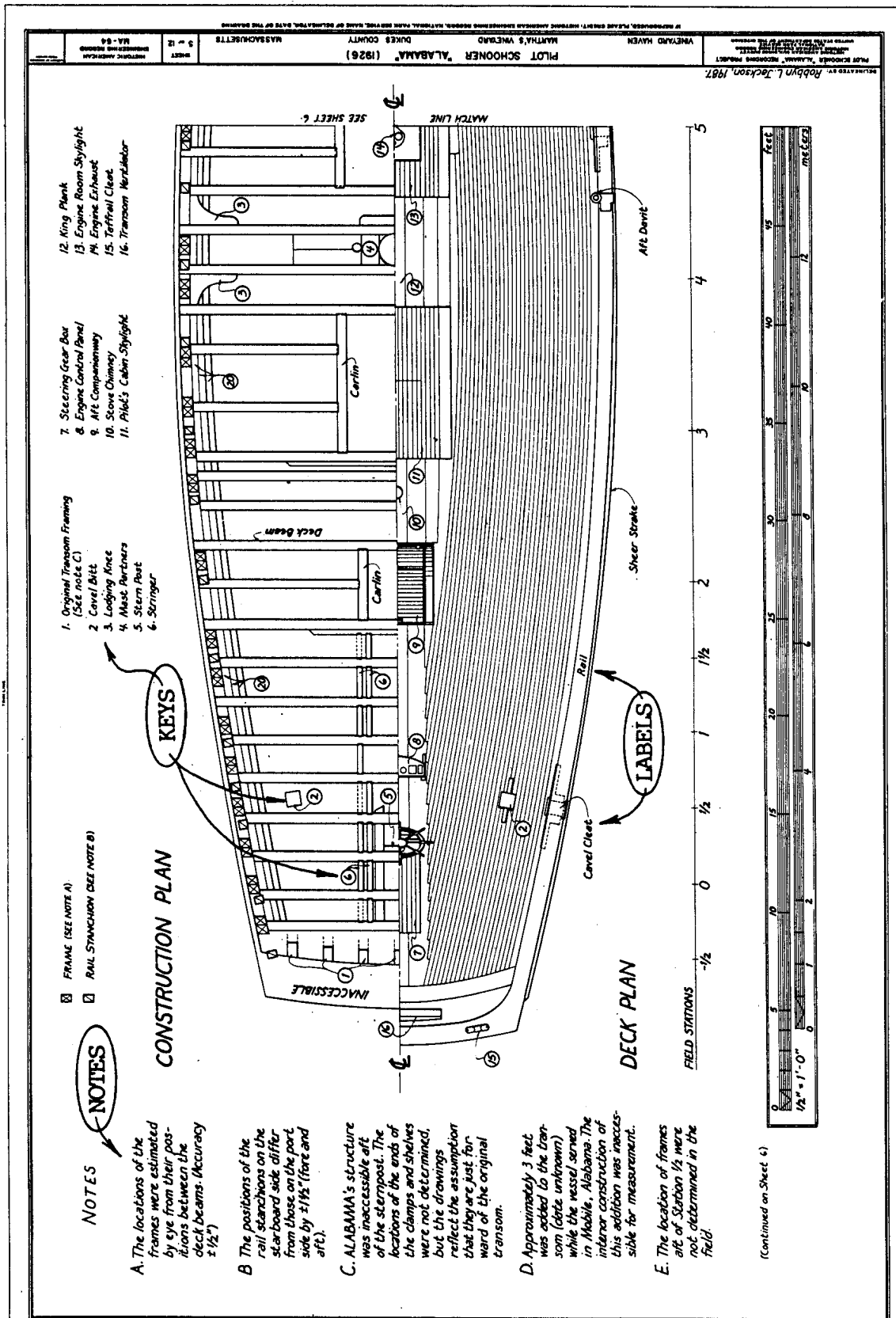

Fig. 4.6.18
 Notes, Labels, and Keys

hence, both systems are used (see Fig. 4.6.18). Generally a label or key citation is no longer than a word or a phrase. Names and descriptions should be as concise as possible; be sure to include both local and general terminology where variant terms for shipboard features are used. Avoid lettering within the linework of a drawing whenever feasible. If it is inescapable, care should be taken never to letter across linework without first erasing enough linework to provide adequate space. In all cases, lettering and numeral sizes should be large enough to be clear and legible when reduced for publication. Be sure to follow the requirements in Figs. 4.6.8 to 4.6.10.

Arrows. Arrows should be used for clarity's sake when simple location of a label or tag near a feature does not resolve ambiguities.

The following is a checklist of subjects to keep in mind for notes. Some items and questions may require the assistance of your review team or a specialist.

MATERIALS

The woods and metals used in your vessel should be properly labeled. In many cases, an exact determination may not be able to be made without expert examination, or members may be hidden or painted. Guidebooks exist for distinguishing the more common species of wood (see References and Resources, Section 4.7), but some kinds of metals may be difficult to tell apart without chemical tests, or knowledge of their function. If a material is unknown to you, do not forego labeling it altogether. You may say "wood, species undetermined," or "non-ferrous metal" if a metal is clearly not iron-based, but its composition has not been established. "Brass or bronze" is an acceptable label if you cannot determine between the two.

WOODS

The woods used in building a vessel may come from almost anywhere. Sometimes they are a function of the region in which the vessel was built; in other cases, woods may have been ordered from other areas, or have been on hand when the vessel was repaired at a point far from where she was launched. In general, however, Douglas Fir (*Pseudotsuga menziesii*) is a common shipbuilding wood on the west coast, white oak (*Quercus alba*) in the east, yellow pine (*Pinus palustris* or *Pinus echinata*) in the south. Because of the variances in regional English terminology for woods, it is best to pin down the Latin botanical name for the species in your vessel. Even if you can only identify the species (e.g. "Pine") but not the variety without professional assistance, the Latin species designation should be given (e.g. *Pinus spp.* for "pine species").

METALS

Some common metals and alloys are very easy to distinguish by the color of the bare metal (iron, copper, aluminum, yellow brass, red brass, bronze, etc.), but it can be very hard for a layman to distinguish between some brasses and bronzes, or wrought iron and steel. (Yellow brass and bronze are distinct copper alloys, but both have a yellow color). A magnet can be a handy thing for testing painted features for ferrous or nonferrous metal content, but it won't distinguish between cast iron, wrought iron, and steel. (Most stainless steels are nonmagnetic.) Wrought iron, grey cast iron, and steels are distinguished from each other by their structure. Grey cast iron (as opposed to some cast malleable irons) is crystalline and brittle. Wrought iron has a fibrous structure due to inclusions of slag in the forging process. Steels are iron alloys, which are not usually brittle and contain no slag. When corroded, the fibrous structure of wrought iron stands out immediately; cast iron and steels tend to pit--cast iron to a much lesser extent than steel. At present, the term "wrought iron" is often used incorrectly for forged or hot-rolled mild steels.

Wrought iron was used extensively in the 19th century, and was gradually replaced by steels between the 1860s and 1900s. The function of an object may be a clue to its composition: castings of zinc are often fastened to steel hulls to retard electrolytic corrosion of the steel; cast iron is used for old galley stoves, cylinder blocks, and machinery frames; wrought iron for forged fittings like mast rings, trestles, and other parts of rigging; brasses and bronzes are used extensively for small fittings exposed to the weather. Lead may be used in sheets or castings for various purposes; its relative softness and grey color identify it readily.

Scantlings. A list of the dimensions of structural members is called "the scantlings"--it can also be used to indicate materials. Scantlings should appear on inboard profiles or sections of vessels. Even if documentation is being carried no further than lines or deck plans, scantlings should appear on the drawings somewhere.

Paint Colors. HAER documentation is all black and white, so some verbal means of recording color is essential. It is best to borrow or purchase a *Munsell Book of Color* and cite colors by their Munsell Color Number. Color descriptions (bright red, dark green, sky blue, yellow ocher) can be fairly subjective, but in a pinch they are better than nothing. Contemporary market terms (Charleston Green, South Bay Yellow) are virtually useless, especially to future researchers.

Alterations. New features, major repairs, or significant alterations should be pointed out with notes. Dates should be included if they can be determined. If a precise date or year is not available, it may be possible to "bracket" a feature's age. Suppose you have two photos, one dated 1890, the other 1905, and no data for the years between. A feature such as a new deck house appearing in the 1905 photo could be labeled as "Added between 1890 and 1905, based on available historical photographs." In

some cases, new materials may be graphically distinguished from old by *pochés*.

Prior Documentation. Are you presenting older documentation (drawings, written data, lines from half-models) which you are only adding to or modifying? This should be clearly indicated, with references and locations given for the earlier documentation.

On-paper Reconstructions. Sources used in reconstructing a vessel or its features to original conditions or a specific point in its history should be cited as fully as possible in a convenient area of the drawing. This applies to old photographs (source? date? owner? photographer?), written materials (diaries? log books? published sources?), oral sources, and drawings of all kinds.

Archeological Evidence. Clues to earlier features or patterns of use should be cited when significant. Sockets, holes, paint ridges, splices or patches, notches, and so forth may all be indicative of earlier uses, structure, fittings, or machinery.

Field Procedures. Important goals or methods of your field procedures should be included where they explain how you derived certain information or omitted particular features or parts of a view. "Inaccessible" should be labeled in areas where structure cannot be drawn; if something has been inferred, the inference must be stated. "Omitted for clarity" should appear when some extant feature is unexpectedly dropped from a view in order to show something else. (Is there some other portion of the documentation, such as a photograph, where the omitted features may be seen?) Standard details should not be summarily omitted, at least not without mentioning where they may be found--standards change, become obsolete, and may be obscure in future centuries. Error tolerances ("∇...") should appear in overall dimensions, and estimates of errors in notes.

Machinery. Note the manufacturers, dates of construction (or patent dates), capacities (horsepower, watts, gallons, tons, etc.), model numbers, serial numbers, cylinder bores and strokes, and other vital statistics of existing machinery. Such information may be cast into frames or be found on builder's plates. Dates the machinery was in service might also be provided, if available. Directions of motion (e.g., rotation of propeller) should be noted where appropriate.

Bits and Pieces. Things like the following should be noted as necessary: accommodations and spaces, structural elements, machinery, fittings, details of construction, rigging, etc.

TITLE PAGES

Each set of drawings for a vessel will have an introductory title sheet, which usually contains four or five things (see Figs. 4.6.19 and 4.6.20):

Heading. The name of the vessel should appear at the top of the sheet in a hierarchy of fonts (see Fig. 4.6.22). You might consider adapting the lettering from the bow or transom if the style is sufficiently distinctive or attractive (see Fig. 4.6.23). (Remember to note on the drawing that the vessel is the source of the lettering style in such cases; or, if you have indulged in a bit of fanciful graphics work which might be mistaken for something aboard the vessel, be sure you state that it is *not* drawn from anything aboard.) The vessel's rig type should appear above the name in smaller lettering (e.g., pilot schooner, or bug-eye, etc.). The year the vessel's keel was laid (not her launching) should also appear in numerals smaller than the name. HAER ordinarily supplies its teams with a series of cartographic lettering style templates for title lettering, such as Keuffel & Esser Co.'s (K&E Leroy) No. 61-1250. Scribes are available which can expand or condense the letters (change their height-to-width ratios) for various effects. Helpful hints for spacing letters properly are given in Fig. 4.6.24.

Heading Content and Lettering Sizes. Title sheet heading should contain at least the first three and possibly as many as all five elements listed below. Recommended lettering sizes are included. All lettering must be in ink; transfer lettering is prohibited because of its unstable adhesives.

1. NAME OF VESSEL in letters 1" to 1 3/4" high, ALL CAPITALS (in most cases this should be the most prominent historical name of the vessel; no secondary names should appear here).

2. VESSEL'S RIG (e.g. schooner, barkentine, etc.) in letters 5/8" to 1" high, either all capitals or upper and lower case.

3. CONSTRUCTION YEAR in numerals 3/4" to 1 1/4" high, always smaller than the vessel's name, larger than the rig designation.

4. VESSEL'S LOCATION (city and state, no county) in letters 5/8" to 1" high, all capitals or upper and lower case. The location should only be added to the title heading if the vessel is permanently located as part of a museum collection, abandoned on shore, etc.

5. CORPORATE OWNER (e.g. White Star Lines, New Jersey Central, etc.) in letter 3/4" to 1 1/4" high, all capitals or upper and lower case. (This should be added only if the vessel was built for or spent most of her career with this owner under her name as given in the title sheet heading; it may be omitted if space on the sheet is too tight. Corporate logos or letterhead styles may be used here, but you have to check with the company or its successors for permission to use them. An unobtrusive note should always appear on the sheet acknowledging sources for such graphics.)

Outboard Profile or Illustrative View. A starboard profile (right side elevation) is the standard. In some cases, the profile may show the vessel in an original configuration if the original conditions can be documented through photos or other sources. A note describing such

4.6.32

Measured Drawings

sources should accompany the view. An illustration based on historic drawings or photos

may be used in place of a measured drawing if noted .

Adapted from title sheet for Schooner WAWONA, HAER No. WA-14, Sheet 1 of 7

SCHOONER
WAWONA
 Seattle, Washington
 1897

Fig. 4.6.22

Lettering Styles. Block Roman (serif) lettering is strongly recommended, and there are numerous variations to choose from. You may trace enlargements of existing styles (transfer lettering, letterheads, photographs, etc.) or base the style on nameboard rubbings. Failing these, large lettering templates such as Keuffel

and Esser (K&E) Leroy No. 61-1250 (Cartographic) are used by HAER (see *Wawona* heading above). Non-Roman lettering is acceptable only if it is adapted from something closely associated with the vessel (see *Reporter* below). A note should appear stating the source for the lettering.



Fig. 4.6.23

Nameboard enlarged as example for title lettering from profile of Ship REPORTER, HAMMS No. 2-57, Sheet 2 of 2

Esthetics. An amateurish appearance should be avoided; if you cannot construct letters well, you are urged to trace existing styles or use templates. Pay attention to letter spacing. Consistent spacing is achieved by keeping the

areas between letters fairly constant. Sometimes the minimum for this area is dictated by adjacent letters with a lot of space between them, such as a K or an L preceding an A.

Taken as example from title block of Schooner WILLIAM BISBEE, HAMMS No. 8-62, Sheet 3 of 3

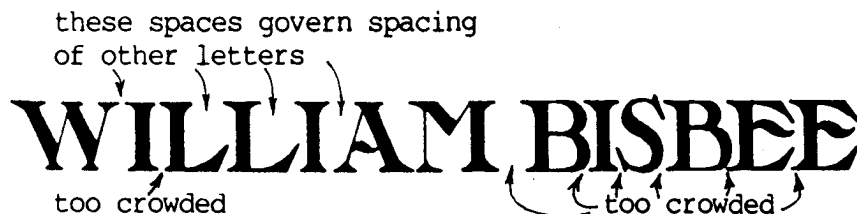

Fig. 4.6.24



better spacing

General Description. The data listed below should be included on the drawing. Dimensions and other information from official descriptions should be labeled as such, and a complete copy of the description included with the historical report. The official length and other dimensions frequently bear little resemblance to a layman's idea of length, since the official figures are the products of rule book formulas. See the section on admeasurement in Section 4.9 (Appendices) for a further discussion and resources on this subject.

Official number (if applicable)

Designer/builder

Place built

Dimensions:

Length (if able, specify whether on deck, at water line, etc.)

Beam (maximum width of main deck)

Breadth (maximum width of hull)

Depth (define)

Draft

Tonnage (note whether registered, net, gross, displacement)

Rig:

Number of masts

Sail area

and/or

Number of Engines (include

horsepower, shaft revolutions, cylinder sizes)

Boilers

Statement of Significance. A brief historical account of the vessel should be given, noting the significance of the vessel, highlighting important aspects of her history up to the present. It should contain the essence of the formal historical

report and not run more than 200 to 400 words, depending on space.

Project Credit Statement. A project credit statement must be included, listing the names of all organizations cosponsoring the project, team members' names and affiliations, and any special contributors or acknowledgements. A model for use by HAER teams on their documentation appears below:

THIS RECORDING PROJECT IS PART OF THE HISTORIC AMERICAN ENGINEERING RECORD (HAER), A LONG-RANGE PROGRAM TO DOCUMENT HISTORICALLY SIGNIFICANT ENGINEERING, INDUSTRIAL, AND MARITIME WORKS IN THE UNITED STATES. THE HAER PROGRAM IS ADMINISTERED BY THE NATIONAL PARK SERVICE, U.S. DEPARTMENT OF THE INTERIOR. THE (name of project) RECORDING PROJECT WAS COSPONSORED DURING [THE SUMMER(S) OF (years)] BY HAER AND (list of all cosponsors).

THE FIELD WORK, MEASURED DRAWINGS, HISTORICAL REPORTS AND PHOTOGRAPHS WERE PREPARED UNDER THE GENERAL DIRECTION OF [name], CHIEF, HAER, AND BY (name), HAER PROJECT LEADER. THE RECORDING TEAM CONSISTED OF (name), PRINCIPAL HISTORIAN [AND/OR TEAM SUPERVISOR]; (name), AND (name), ASSISTANT HISTORIANS; (name), AND (name), DELINEATORS. FORMAL PHOTOGRAPHY WAS DONE BY (name).

The affiliations and professional status of the historians and delineators should be included as appropriate (e.g., name of university, museum, or other organization from which the person came, and whether the person is a historian, naval architect, engineer, shipwright, architect, student, volunteer, etc.). Obviously the credit statement will be different for non-HAER sponsored projects.

When laying out and lettering long blurbs, it will be in the interest of time to letter the entire text on vellum as a single column whose width is the same as the columns on the title sheet, using the spaces between paragraphs as "breathing" spaces when the number of text lines do not divide up evenly among the columns. When everything is in place, the text can then be traced onto the mylar title sheet.

Location Map. Inclusion of a location map for the recorded vessel is a matter of judgment. Is the vessel a museum ship or a hulk? In this case she is probably permanently located, and a map would be appropriate. Is she in private hands and/or in active service? In this case, a map may be misleading, since the vessel may be in several places, or may even be sold to new owners. A textual citation about where she was recorded is probably sufficient for the title sheet. More detailed information concerning the project's circumstances, addresses of owners, etc., belongs in the field report or the written history.

In any case, a location map should be clearly

and boldly delineated, showing major geographical and political features, with the vessel's location clearly indicated (see Fig. 4.6.21). Major roads, cities, state and county boundaries, water bodies, etc., should be shown. Additional smaller maps or diagrams showing the vessel's location with respect to a state or region are useful for obscure locations. The UTM (Universal Transverse Mercator) coordinates should also be given for the vessel. These can be easily derived from a recent U.S. Geological Survey topographic map. See Section 4.9 (Appendices) for further information about UTM coordinates.

Index to Drawing Set. This should only be necessary for sets of 10 or more sheets. An index on the title sheet does a lot to help a user locate a particular view--he doesn't have to fumble through countless drawings trying to find what he wants. Sets with 10 sheets or less are not a burden to search through, so a sheet index here is more of a kindly convenience than a necessity. If for some reason an index cannot be included on the title sheet due to priority of

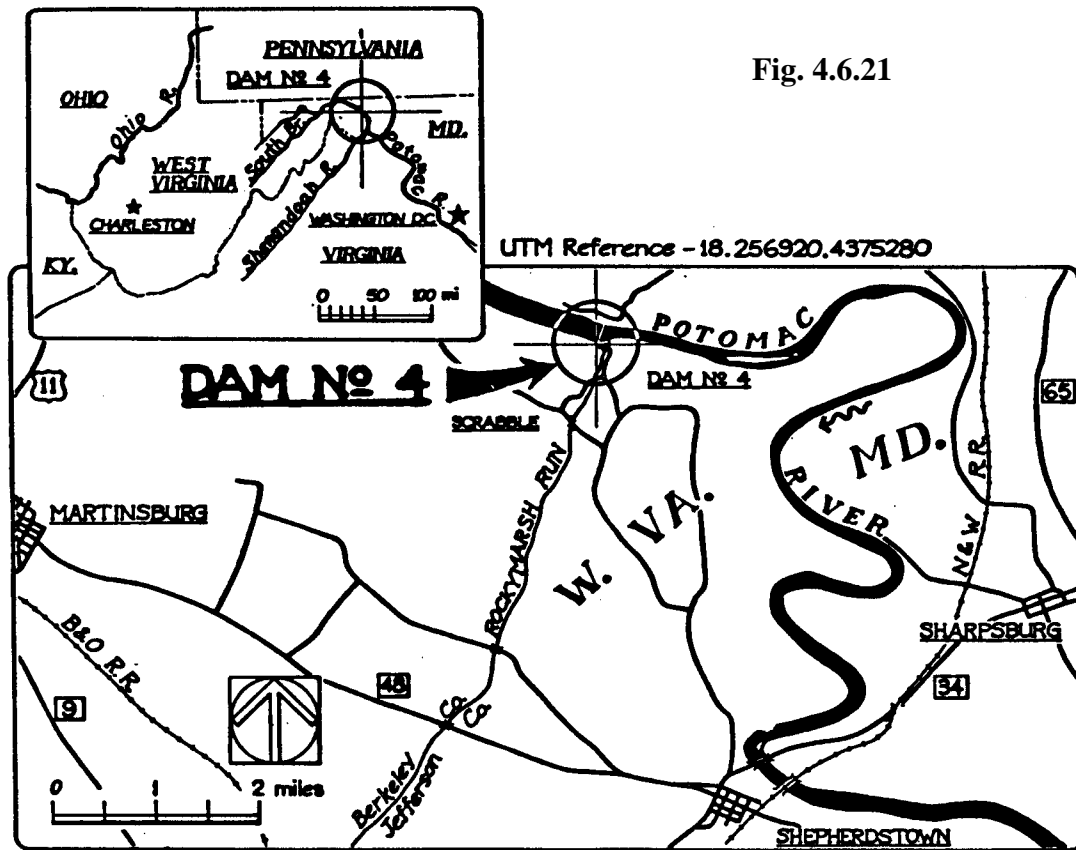

Fig. 4.6.21

Drawn and reduced from USGS 7.5 min. series; Shepherdstown, W. Va. & Md. quadrangle map.

other information, you still need to indicate on the title sheet where it can be found (e.g., "Index: see Sheet 2").

LINES DRAWINGS

The following guidelines assume that your ship lines will be lifted and drawn by hand. HAER will accept computer-generated lines drawings that meet the HAER standards.

Computer-generated plots should carry notes as to the software and hardware used. In some cases, you may have opportunity to trace or otherwise reproduce existing lines drawings. If so, the reproductions should carry complete source information, as well as noting whether you field-checked the lines drawings against the vessel or not. Check the drawings you have for scale and distortions before attempting to trace or copy them--there can be hidden problems. The vessel may not have been accurately built to the drawings, and there may have been dimensional changes to the base material of the drawings.

Format. The format of lines drawings has a long-standing tradition. Archeological investigations have shown that some ancient Greek boat builders used something similar to full-sized lines drawings scribed into the floors of their shops for lofting and erecting their boats. In the past hundred years, it has become standard to show three views when drawing lines: sheer plan (buttock lines) and half-breadth plan (water lines), both usually for the starboard half of the hull, and a body plan where a common centerline is used to show half-sections from midships forward on the right (forebody plan) and from midships aft on the left (afterbody plan). A fourth view, diagonals, may be superimposed on the half-breadth plan or shown separately. Each of these views takes advantage of symmetry to economize on space and drawing time. This same standard is followed by HAER.

For some, it has also become standard practice to make a single drawing by superimposing these views, probably to save space or permit easier cross-checking of points on a hull between various views. This is perfectly acceptable as a preliminary drawing, if you are used to the procedure and can avoid errors using it. However, it is HAER's opinion, as a program whose records are used by a broad section of the public, that such superimposition creates confusion for all but those trained to unscramble it (see Fig. 4.6.25). In some cases, layout and sheet space requirements may suggest that the body plan be superimposed on the sheer plan as a space-saving device (see Fig. 4.6.26). This is acceptable to HAER when clarity doesn't suffer. Clarity and space-saving probably cooperate best on long vessels or vessels whose midbody shape changes little where the body plan would be drawn. These cases permit you to omit the sheer plan where the body plan is inserted without losing much information on the sheer plan (see Fig. 4.6.27). In cases of diagonals superimposed on half-breadth plans, some have found it helpful to draw the diagonals counter to the water lines, that is, with the diagonal plane centerline outboard of the plan (see Fig. 4.6.27). In most cases, it is best to simply keep the views separated (see Fig. 4.6.28).

Lines to Inside or Outside of Hull? Since lines drawings may be done to either the inside or outside of a hull, a prominent note on your drawings must indicate which condition you are showing. Lines to the inside of a hull give a shipwright an easier time lofting frames for a vessel; lines to the outside are in some cases better for hull performance calculations, but they are certainly much easier to record in the field from intact vessels.

Some lines drawings, especially for wooden vessels, show lines drawn only to the rabbet and deck sheer lines, leaving out the keel and rudder. Some include not only the keel and rudder, but

the bulwark as well. HAER requests that the keel, rudder, and bulwarks be shown, especially

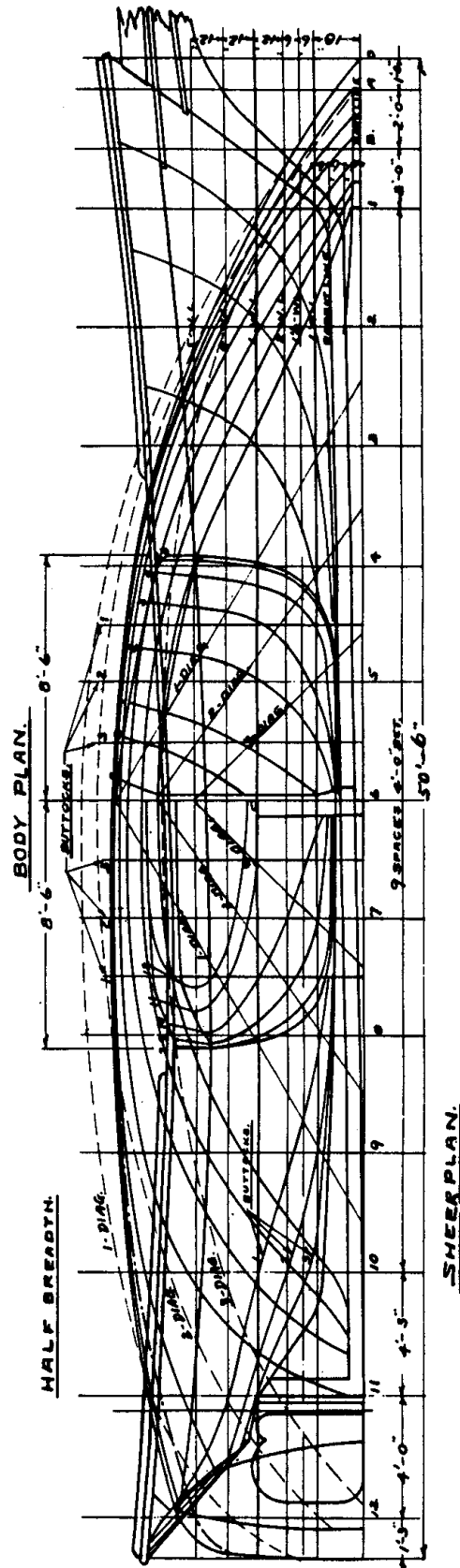

Adapted for illustrative purposes from ANNIE HOLMES, HAWKS No. 4-2, Sheet 3 of 4

Fig. 4.6.21

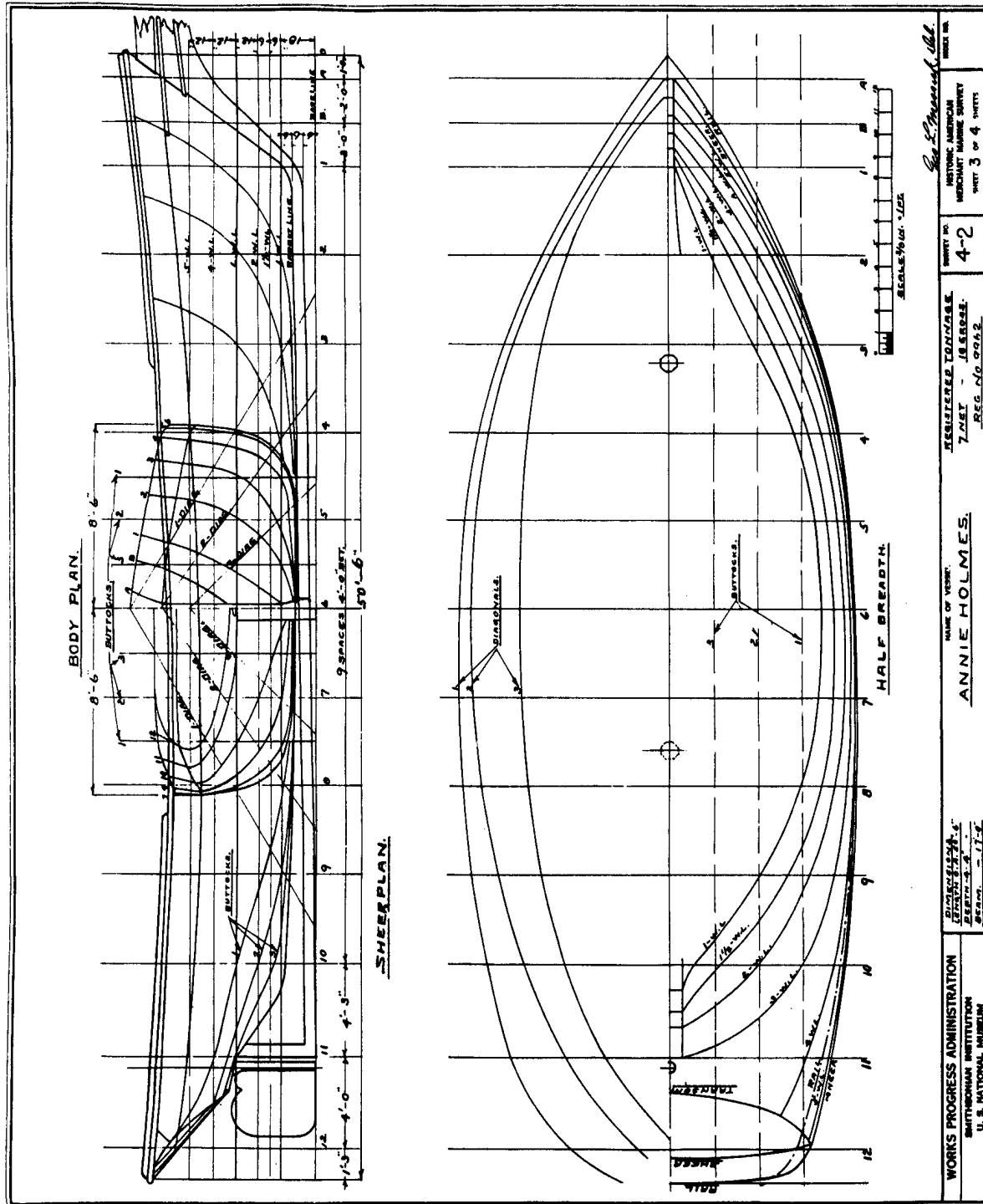

Works Progress Administration
Baltimorean Institution
U. S. NATIONAL MUSEUM

DATE: 1/24/34
BY: J. H. ...
SCALE: 1/4" = 1'-0"

NAME OF VESSEL: ANNIE HOLMES

REGISTERED TONNAGE: 7 NET TONS

REG. NO. 9062

SWIFT NO. 4-2

HISTORIC AMERICAN MERCHANT MARINE SURVEY
SHEET 3 OF 4

Fig. 4.6.25

Fig. 4.6.25
Completely Superimposed Lines
(unacceptable)

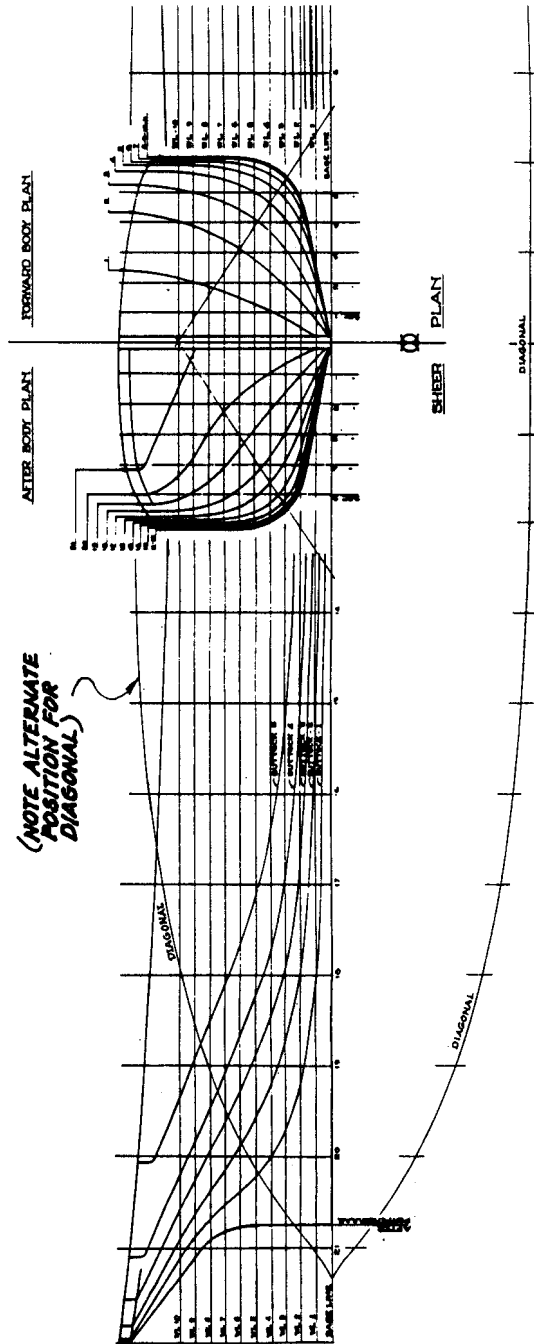

Adapted for illustrative purposes from FRANK WOODS, BMMMS No. 14-18, Sheet 1 of 4

Fig. 4.6.27
Partially Superimposed Lines
(acceptable, but not preferred)

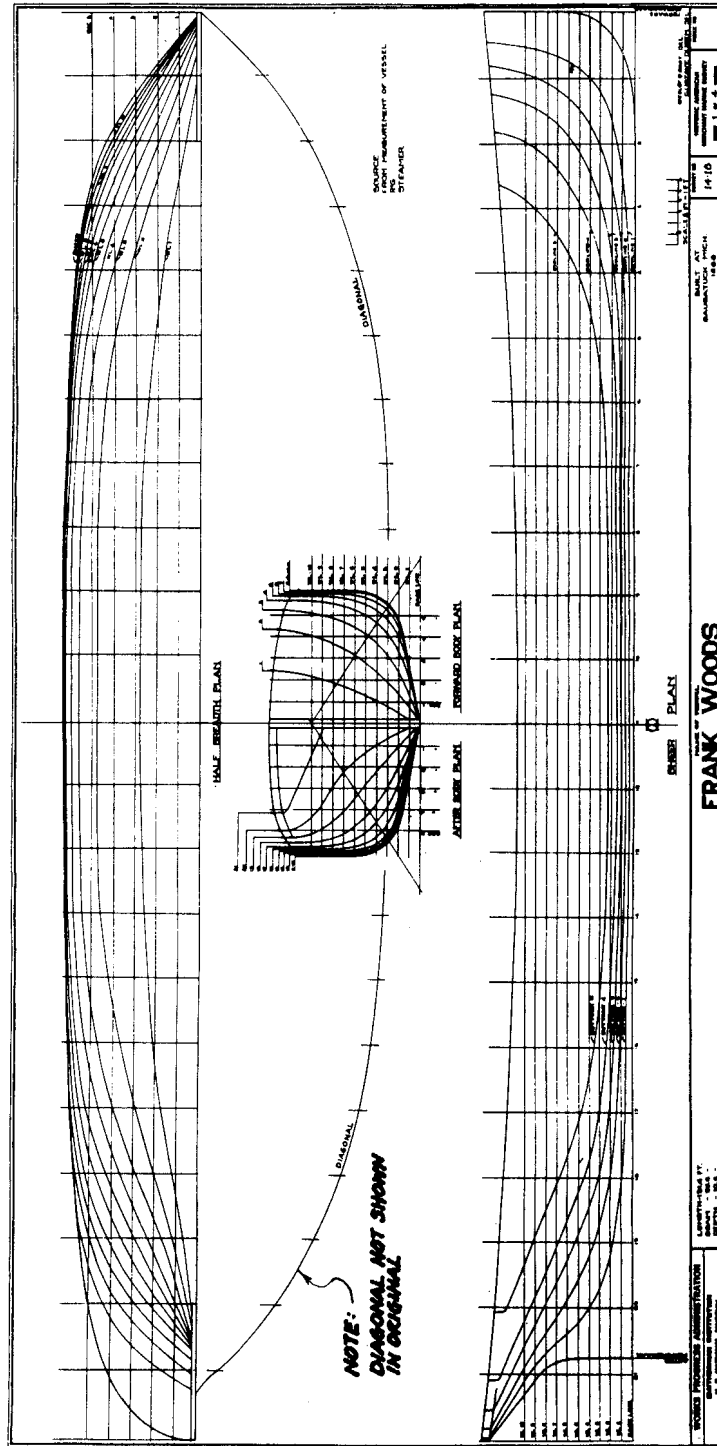

Fig. 4.6.28
Separate Lines Views (best)

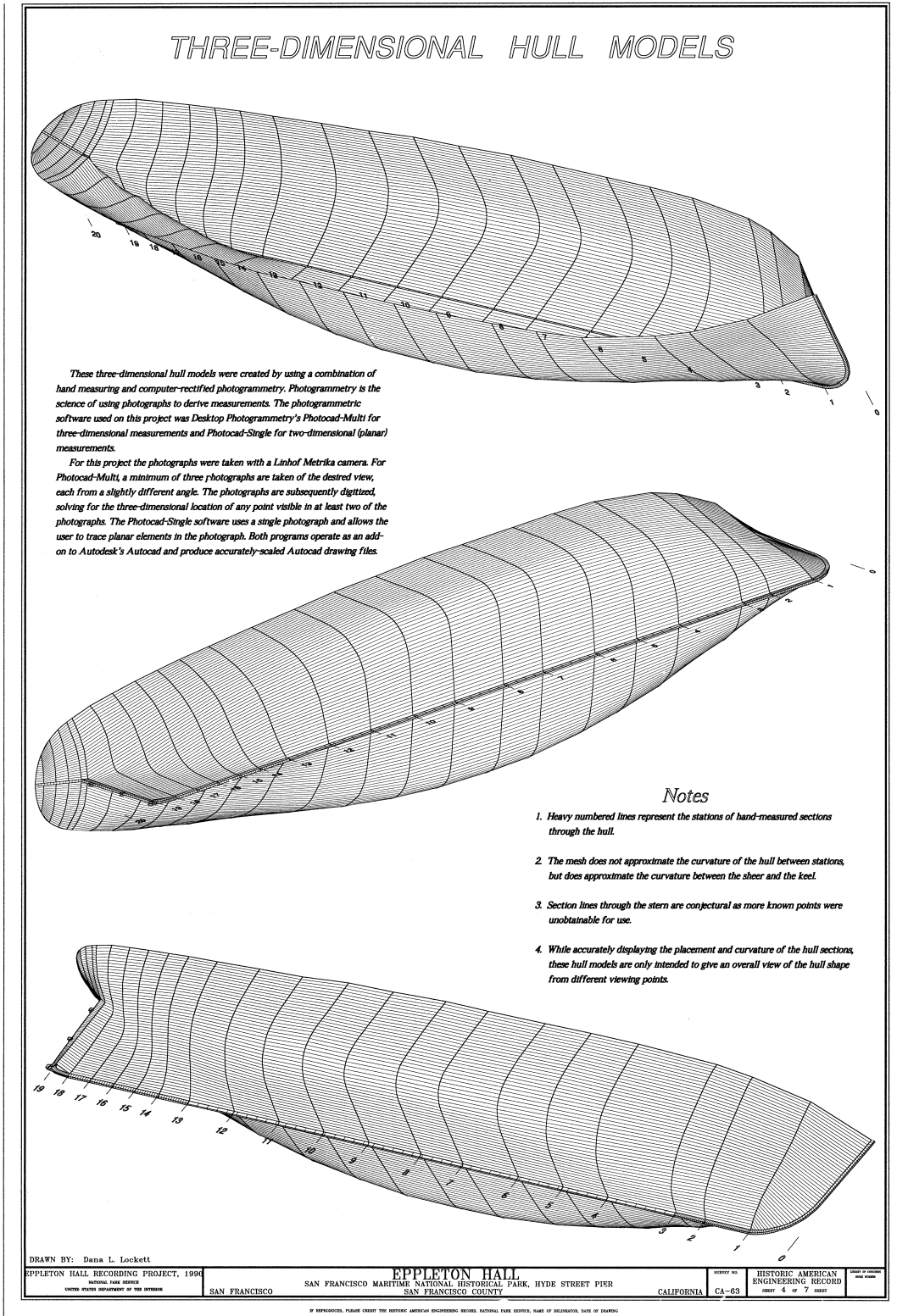
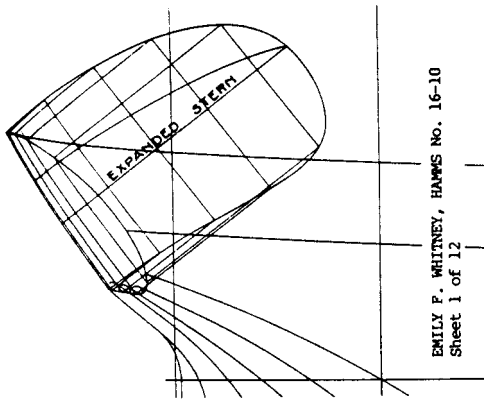
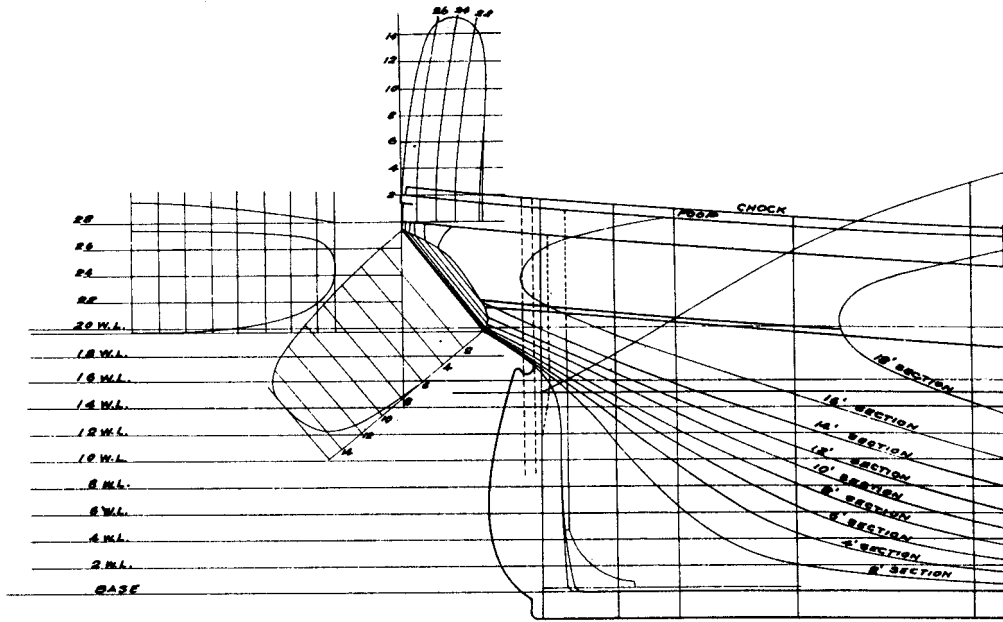
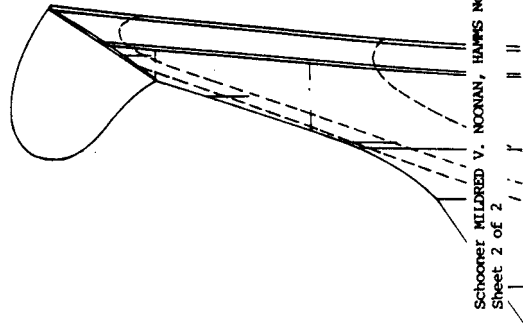

Fig. 4.6.28a
Three-dimensional Hull Modeling



EMILY F. WHITNEY, HAMMS No. 16-10
Sheet 1 of 12



Schooner MILNED V. NOONAN, HAMMS No. 2-46
Sheet 2 of 2

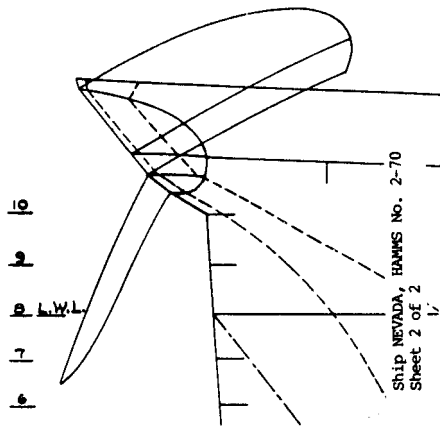

SHIP NEVADA, HAMMS No. 2-70
Sheet 2 of 2

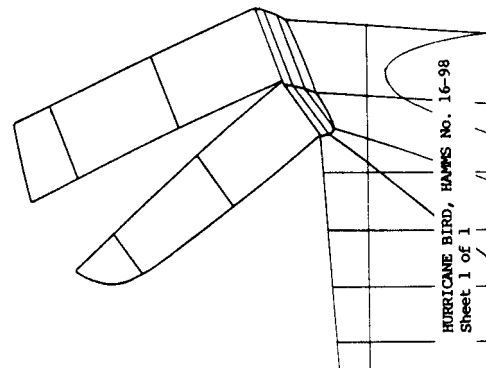

HURRICANE BIRD, HAMMS No. 16-98
Sheet 1 of 1

Fig. 4.6.29
Transom Expansions

if the keel bottom (or worm shoe) is used as a base plane. These features must be recorded somewhere in the drawing set, and it seems just as well to cover their outlines in the lines plan

Scale. A scale of 1/4" to the foot is a traditional departure point in choosing a scale for lines drawings. In general, the lines of vessels shorter than 60 feet should be drawn on one HAER sheet (3/8" or 1/2" scale). Unless it is important to your project to draw on an oversized sheet (see "Oversized Sheets," p. 4.6.5), longer vessels are perhaps better split up and drawn on two or more sheets. This is not a hard and fast rule. The first concern is to draw lines at a scale large enough for a user to scale from with some reasonable accuracy, but there are some important factors associated with this concern. If a team has gone to the trouble to lift a vessel's lines to ∇ 1/2" in the field, it seems reasonable to draw the lines at a scale commensurate with the level of precision to which the job was done, especially if you are creating archival records. A 300-foot vessel drawn at 3/32" scale would give a user a general idea of the hull shape, but the accuracy with which the lines could be reasonably well drawn or scaled at that size is probably no better than ∇ 3" (scale) at best, even if the field work was done to ∇ 1/2". A larger drawing scale would permit a higher degree of precision. On the other hand if you are recording a dilapidated hulk whose lines are really the result of considerable conjecture, it is silly to draw the lines at a large scale and claim a highly accurate representation of that particular vessel's hull. The concern for precision is not so much that the vessel could be reconstructed from the lines--sections and frames are lofted full-size when building a vessel, and any irregularities in lines drawings are taken care of at that time. Recovery of data from drawings with a precision that is representative of the field work (and vessel significance) is the primary concern.

Layout. It makes little difference whether the half-breadth plan lies above the sheer plan or vice versa, just so they are not superimposed. Diagonals may be drawn on the half-breadth plan, or separately if desired. Other data curves, such as curves of area, curves of buoyancy, etc., are not required, since they can be derived from the lines data. However, they should be drawn if they are needed to bear out some point of significance discussed in the historical report.

Body Plan Measurements. The body plan of a vessel must be accompanied by a table of body plan measurements (see Fig. 4.6.30). This type of table is sometimes referred to as a table of offsets, which is ordinarily used in lofting and shows measurements to the inside of the hull surface. A table of hull measurements describes the curve of each section or station by means of a series of rectangular coordinates. Measurements are scaled for the table from the body plan and are taken along the water lines and buttocks shown in the lines plans. Horizontal measurements, or half-breadths, are taken from the central buttock plane, while vertical measurements, or heights, are taken from a base plane. All dimensions should be shown in feet, inches, and eighths of an inch; that is, 8'-7 1/2" should be represented as 8-7-4 (1/2" = 4/8"). Blank spaces where no figures apply should be struck through with a diagonal line or an "X" so users will know that no figure was inadvertently omitted. The table should always be accompanied by an estimate of the figures' accuracy, and notes for both common and any unusual conditions (for example, you should note whether the measurements are to the inside or outside of planking, and whether your lines are direct from the vessel, or have been corrected or reconstructed). See Fig. 4.7.4 for an example.

How Many Stations Should Be Drawn?

Technically, a vessel's hull shape could be recorded by lifting and drawing her lines at any number of stations, the more the better. (The number of stations drawn is not necessarily the same as the number of stations lifted.) However, beyond a certain point, you don't gain that much

more for all the added effort. Some lines drawings made for construction purposes may show a hull section at every frame (resulting in as many stations as the vessel has frames) so that the drawings can be used for lofting. Others will show hull sections placed as hull shape and economy of time indicate (see Fig. 4.6.31).

Those who wish to draw lines for calculating a vessel's displacement (or making other hydrodynamic studies) will choose stations according to "Simpson's Rules," a method used worldwide for hydrodynamic calculations. Which approach you take--shape or hydrodynamic--may be dependent on your cosponsor's needs, significance of the vessel's hull, or other issues best discussed with your review team. However, both methods record hull shape, and all other things being equal, HAER strongly suggests that your choice of stations be governed by "Simpson's Rules." Space does not permit a complete discussion of Simpson's Rules here (see Section 4.8 [References and Resources].)

For drawing lines, it is sufficient to know that a vessel must be divided at her floating water line (between her fore and aft perpendiculars) into any number of even equal spaces that will give an *odd* number of stations--see Fig. 4.6.32. (Remember, if you label your first station "0", station "10" is the *eleventh* station.) The perpendiculars are set where the bow (at the rabbet line) and stern emerge from the water at the floating water line. Ten equal spaces and 11 stations is the most common choice, however smaller vessels may be drawn with fewer stations, and very large ones (over 250 or 300 feet) may well require more. For shape, fractional stations (0-1/2, 1-1/2, etc.) should be included at the bow and stern to better define the hull there. You may need to set up some additional stations beyond the perpendiculars, in order to record the shape of an overhanging stern, for example.

ALL DIMENSIONS BELOW ARE GIVEN IN FEET, INCHES AND EIGHTHS OF AN INCH (See note A).

		STATIONS																	
		-1/2	0	1/2	1	1 1/2	2	3	4	5	6	7	8	8 1/2	9	9 1/2	10	10 1/2	
HEIGHTS ABOVE BASE	RAIL CAP	16-2-6	15-11-6	15-9-2	15-7-2	15-5-2	15-4-0	15-4-2	15-6-0	15-9-2	16-1-6	16-8-0	17-3-6	17-9-0	18-3-0	18-9-0	19-3-4	19-10-0	
	DECK TOP AT 6	14-10-6	14-7-6	14-5-0	14-2-4	14-0-6	13-11-6	13-11-4	14-1-2	14-4-6	14-8-6	15-3-0	15-11-0	16-4-2	16-10-0	17-4-0	17-10-6		
	SHEER	14-6-2	14-4-2	14-2-0	14-0-0	13-10-0	13-8-6	13-8-2	13-10-2	14-1-2	14-6-4	15-0-2	15-8-6	16-2-0	16-8-0	17-2-6	17-10-2	18-6-0	
	10' BUTT					13-7-2	11-4-4	9-6-0	8-11-2	9-5-6	11-10-6								
	8' BUTT		13-4-6	11-7-2	10-5-0	9-4-6	8-6-4	7-5-6	6-11-0	7-1-6	8-7-2	11-1-0							
	6' BUTT	12-5-6	11-3-6	10-2-0	9-2-2	8-2-0	7-4-4	6-4-2	5-10-0	5-10-4	6-9-0	8-6-6	11-5-2	14-0-0					
	4' BUTT	12-2-6	10-10-2	9-6-0	8-3-6	7-3-6	6-5-4	5-5-6	5-1-2	4-11-6	5-5-6	6-8-0	8-8-2	10-3-2	12-7-0	16-2-6			
	2' BUTT	12-2-0	10-7-6	9-1-2	7-8-2	6-5-6	5-6-2	4-5-6	4-1-4	4-1-4	4-4-6	5-1-4	6-7-2	7-9-4	9-5-0	11-8-0	15-2-6		
	RABBET	12-1-6	10-6-4	8-11-2	6-10-2	2-4-4	1-9-6	2-3-6	2-8-0	3-0-6	3-5-6	4-0-0	4-10-6	5-9-2	7-0-6	8-10-6	11-4-4	15-0-2	
HALF-BREADTHS	SHEER	7-2-0	8-0-6	8-9-2	9-5-0	9-11-4	10-5-4	11-0-4	11-2-4	11-1-0	10-6-4	9-5-6	7-10-0	6-9-0	5-6-6	4-3-0	2-9-6	1-3-2	
	13' W.L.	7-1-4	8-0-0	8-8-4	9-3-2	9-10-2	10-4-4	10-11-6	11-2-0	10-11-2	10-4-2	9-2-2	7-2-6	5-11-0	4-6-2	3-0-0	1-4-2		
	12' W.L.		7-1-4	8-2-2	9-0-2	9-8-0	10-2-2	10-10-6	11-1-0	10-10-2	10-1-0	8-6-2	6-4-6	5-1-2	3-9-0	2-3-2	0-7-6		
	10' W.L.		1-1-2	6-9-6	8-2-0	9-1-0	9-8-6	10-6-2	10-9-4	10-5-6	9-4-6	7-8-0	5-5-6	4-2-4	2-10-0	1-3-4			
	9' W.L.			1-7-2	6-0-2	7-7-2	8-8-0	9-9-2	10-1-0	9-8-2	8-5-0	6-6-2	4-3-4	3-1-0	1-9-2	0-4-2			
	7' W.L.				1-7-6	4-7-0	6-4-6	8-3-0	8-11-2	8-6-2	6-11-6	5-1-0	2-11-4	1-9-6	0-7-2				
	6' W.L.					1-5-4	3-2-0	5-6-0	6-5-6	6-4-0	5-1-2	3-4-2	1-5-6	0-6-2					
	4' W.L.					0-7-6	1-2-0	2-2-2	2-9-6	2-10-6	2-3-2	1-0-6							
	3' W.L.					0-5-4	0-7-2	0-9-4	0-9-6	0-5-6									
HALF-SIDING				0-5-0	0-5-0	0-5-2	0-6-0	0-6-2	0-5-4	0-4-4	0-3-6	0-2-6	0-2-6	0-2-6	0-2-6	0-2-6	0-2-6		
PERPENDICULARS	A		2-1-6	4-0-6	5-5-6	6-6-6	7-4-4	8-3-6	8-10-0	8-9-0	8-0-2	6-9-4	5-2-2	4-3-0	3-2-4	1-11-0	0-6-2		
	B	4-5-0	6-5-0	7-10-0	8-10-4	9-8-4	10-4-4	11-3-4	11-8-4	11-5-2	10-4-4	8-10-6	7-1-0	5-11-6	4-8-6	3-3-2	1-9-6	0-2-6	
	C	7-8-2	8-7-4	9-4-2	10-1-2	11-9-2	11-4-0	12-0-4	12-9-4	11-11-6	11-1-0	8-7-2	7-8-6	6-6-6	5-3-2	3-9-4	2-3-4	0-8-0	

Fig. 4.6.30 Table of Hull Measurements (Table of Offsets)

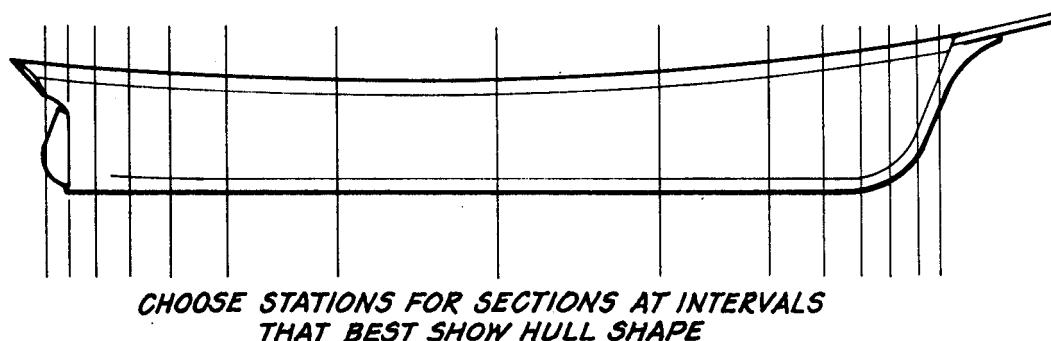

Fig. 4.6.31
Sections Chosen to Show Shape

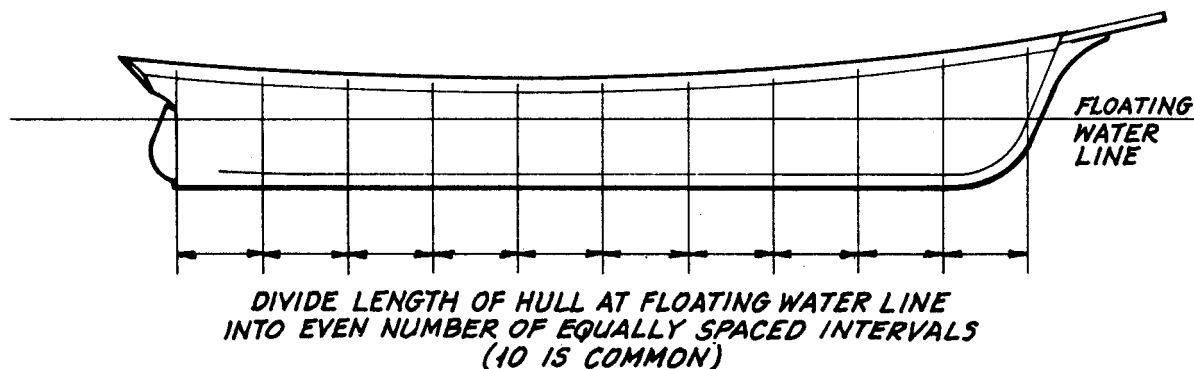

Fig. 4.6.32
Sections Chosen for Displacement

Labeling Stations. Many schemes have been used for labeling stations. Some methods used letters, others numbers. Some started amidships and used letters going aft and numbers going forward. HAER prefers the use of modern practice, which seems to favor the use of numbers alone and to start with "0" at either the forward or aft perpendicular (most likely to permit easy application of Simpson's Rules). It seems easier for some to start with "0" in the stern so that stations read left-to-right in the drawing; others prefer to start with the bow, perhaps because it is the forward end of the vessel.

How Often Buttocks, Water Lines, and Diagonals Be Chosen? The intervals used for buttock and water lines follow no set rules, though the first concern is to place these lines where they are the most effective in describing a hull's shape (see Fig. 4.6.33). A water line plane or buttock plane offers the best control of shape when it intersects the hull surface at a near 90° angle. Due to the changes a hull's surface goes through, the angle of intersection can change dramatically along a given plane of reference. You must choose those planes that offer the best control of shape on the average, and be aware that the lines you draw will be more useful some places than others.

There is no requirement that water lines be set at equidistant intervals; many precedents show water lines at a variety of intervals, often closer together at the bilges of a vessel than up the sides. One water line is almost always set to coincide with the vessel's floating water line. (You may need to consult the project review team about how or where to establish your vessel's trim, especially if she is out of the water.) In most cases, at least one or two water lines are shown above the floating water line to describe the hull higher up at the bow and stern. Water lines have been designated by numbers (e.g., "No. 3"), by heights above a base plane beneath the vessel (e.g., 6'-0" or 10'-6"), or even by depth beneath the floating water line. If water lines are numbered, your sheer plan should indicate their heights somewhere so a user will not have to try to scale them from the drawing. All things considered, HAER prefers that water lines be designated by their heights above a datum plane set beneath the vessel. Some floating vessels may be listing or hogged, so the current floating water line may need to be merely noted and not indicated as a water line if corrected lines are produced.

A minimum of three buttocks is commonly used, almost always set at equidistant intervals. More buttocks should be used on beamier vessels (see Fig. 4.6.34). Buttocks are usually designated by their offsets from the vessel's centerline (e.g., 4'-0"), though other number and letter designations that give less information about the dimensions have been used.

At least one diagonal should be shown. As many as three to five have been used for large vessels. There is no predetermined mechanical formula for setting diagonals. They are usually set at a vessel's bilges or at other places where the hull shape changes in a way not easily represented by buttocks or water lines. A diagonal plane should

be set so it is nearly perpendicular to the surface of the hull along the line of its intersection with the hull. In keeping with this, diagonals are best set between points at *intersections* of water line planes and buttock planes as seen in a body plan (see Fig. 4.6.35). Diagonals are usually drawn superimposed on the half-breadth plan, or as separate plots with their own centerline. Sometimes they are superimposed on the half-breadth plan with the curves counter to the water lines. Diagonals are not projected into the half-breadth plan. They are treated as if the diagonal planes had been rotated to lie parallel to the water lines planes (see Fig. 4.2.6). Because diagonals do not coincide with the three perpendicular systems of planes in a lines plan, they are usually given number or letter names in the body plan and diagonal plots.

Rabbit and sheer lines should also be labeled, in addition to water lines, buttocks, stations, and diagonals. If your lines plan takes up two or more sheets, these features should be labeled on every sheet. Other features such as the rail top, keel (or bug shoe) bottom, etc., should also be labeled for clarity.

Midship Symbol. The midship station in the lines should be marked with a midship symbol, as shown in Fig. 4.6.36. (This is somewhat analogous to marking a centerline with "6".)

Fairing in Lines. Fair lines are drawn to approximate the true shape of a vessel. This is done by averaging a line among numerous points, recognizing that some slight errors and irregularities will occur. In general, the larger the scale used to plot and fair lines, the more accurate the final job is. However, there comes a point of diminishing returns on your time and trouble for whatever increase in precision is secured. "Fairing the lines" not only involves drawing a smooth curve through a series of measured points (see Figs. 4.6.37 and 4.6.38), it also requires you to coordinate the intersections

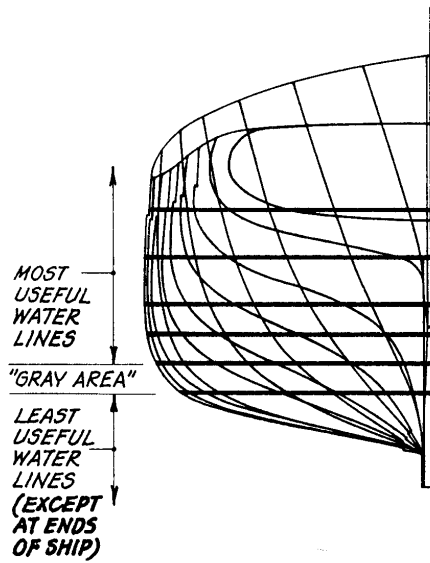

Fig. 4.6.33
Choosing Water Lines Intervals

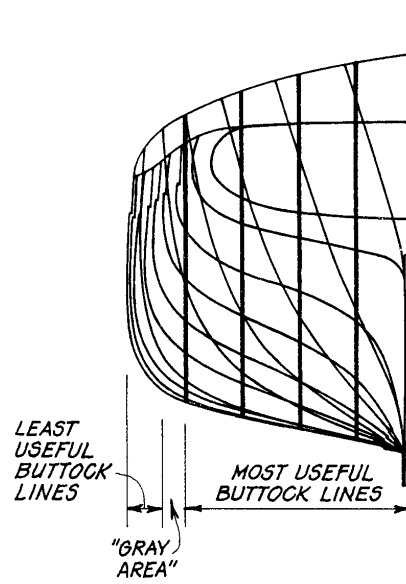

Fig. 4.6.34
Choosing Buttock Line Intervals

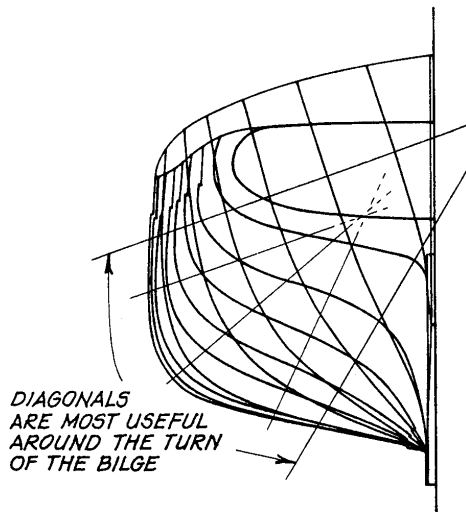

Fig. 4.6.35
Choosing Diagonals

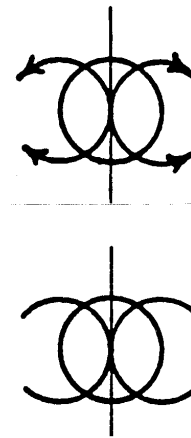

Fig. 4.6.36
Midship Symbol

among the lines in the three views (see Figs. 4.6.39 to 4.6.41). For example, if the No. 1/2 section crosses the 16-foot water line in the body plan at a point 14'-4" from the vessel's centerline, the half-breadth plan should show the 16-foot water line crossing the No. 1/2 section 14'-4" from the centerline (see Fig. 4.6.40). Similarly, if your sheer plan shows a 4-foot buttock intersecting your No. 0 section plane 15'-0" above the base plane, the No. 0 section in the body plan should cross the 4-foot buttock line at the same 15'-0" height (see Fig. 4.6.41). Sometimes it will take some effort working back and forth between the various views to bring the lines into agreement, especially in areas where the hull shape changes rapidly. Use a pair of dividers to compare and transfer dimensions rather than a scale--it is much more accurate. You should do all you can to bring about agreement without sacrificing large numbers of points obtained in the field (or changing the sections faired from those points) before beginning to alter the sections themselves. This priority is less important if lines are lifted with some degree of imprecision or the hull you are recording is dilapidated. If you have to significantly alter data plotted from careful field work of an intact hull, it may mean you misunderstand how to fair lines, or that something was missed in the field work itself. (Plotting and checking stations in the field can reduce the uncertainties in such cases.)

How to Transform Lines of a Deformed Hull into "Original" Lines. As explained before, it is customary to draw a vessel's lines without the effects of age. You may record a hull which has a 12" hog in it and a twist to boot. Should you draw it this way? Initially, you will have to do a preliminary set of lines showing the vessel "as is" before you can proceed to correct them. Whether the "as is" lines become part of your drawing set depends on the goals of your project: a careful survey performed for repairs, structural evaluation, or archeological study may well require "as is" lines to be drawn. Correcting a set of lines can only be adequately done when you have taken into account how the deformation in your vessel's hull came about.

(This is an excellent problem to put before your review team.) While this is not a good place to digress into hull engineering, you should be aware that many parts of a hull's structure can "give" when it changes shape over time. The deck in a wooden vessel might stretch fore and aft while the keel, though bent, maintains its original length. This can occur if the deck is more deteriorated than the keel, or if the deck was replaced with the hull hogged. The bilges might bulge if the keel hogs but no deck stanchions exist to keep the keel and decks fixed in relative position (where stanchions exist, you should check for abnormal camber in the deck beams). Severe local deformation can result from deterioration, misplaced loads, collisions, etc. Understanding which parts shifted (and which didn't) takes some careful analysis. Sometimes it is a matter of taking sections of the vessel's hull and redrawing them along a trued-up keel plus rotating the sections until all their centerlines coincide with a common central buttock plane. Comparison with the lines of similar vessels can provide an excellent point of departure, but ultimately you must come to grips with what's going on with *your* vessel. In many cases this may require the services of a naval architect, marine surveyor, or shipyard worker.

In all HAER projects, copies of the "as is" lines of your vessel should be enclosed with your field notes for transmittal to the Library of Congress, especially if such plots are not part of the final drawing set. By enclosing these things, future researchers can follow your steps more easily in retracing your procedures. Discussion of your corrections to a vessel's lines should be included in your field report.

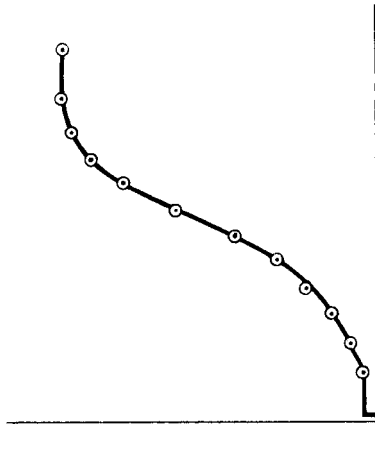

A good set of measurements and a properly faired line may appear like this. (Points measured in field are shown here for illustrative purposes only.)

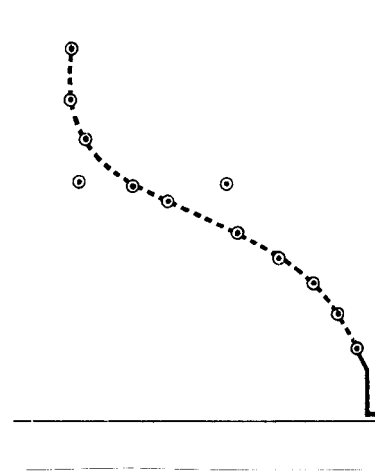

A properly faired line steers an "average" course among recorded points, ignoring (or remeasuring) an obvious errors.

Fig. 4.6.37
Properly Faired Line

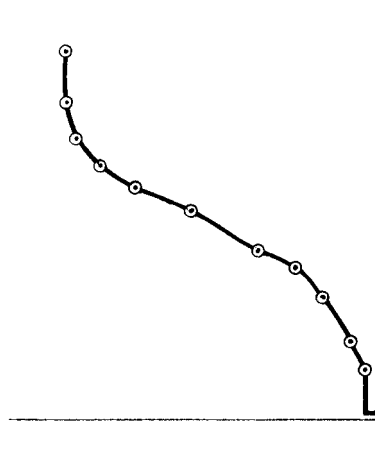

Don't try to fair a curve through every field point. Points which do not lie along a smooth "fair" curve may be erroneous. Remeasure such points if possible, or inspect hull for irregularities your drawing seems to show.

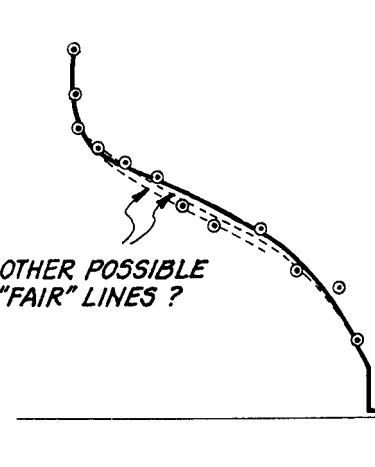

Numerous points that vary significantly from each other and from a fair curve are a sign of poor field technique, unless the hull condition is so poor that such results are unavoidable.

Fig. 4.6.38
Poorly Faired Lines

Adapted from Schooner WAMONA, HAZER No. WA-14
Sheet 5 of 7

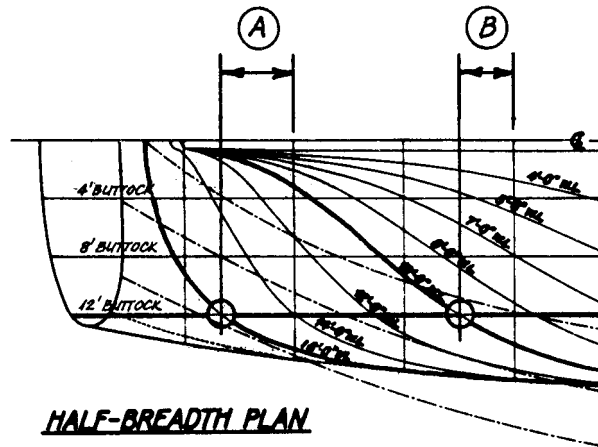

HALF-BREADTH PLAN

***DIMENSIONS "A" SHOULD BE EQUIVALENT,
AS SHOULD "B". FOR ACCURACY,
COMPARISON SHOULD BE MADE WITH
DIVIDERS, NOT A SCALE.***

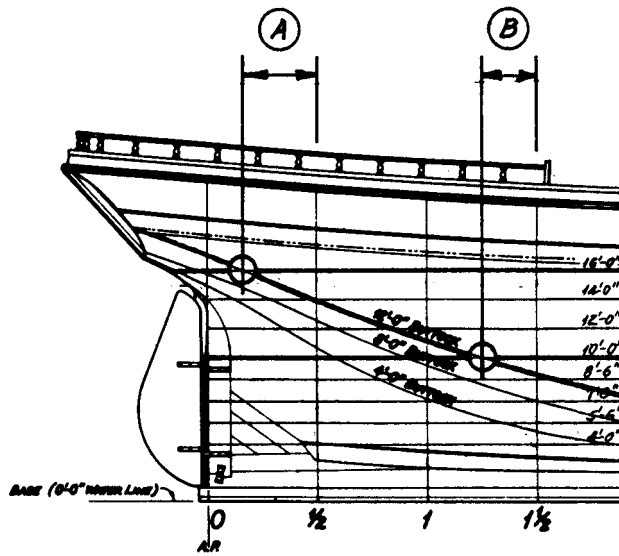

SHEER PLAN

Fig. 4.6.39
Agreement Between Half-Breadth Plan and Sheer Plan
(water line and buttock line intersections)

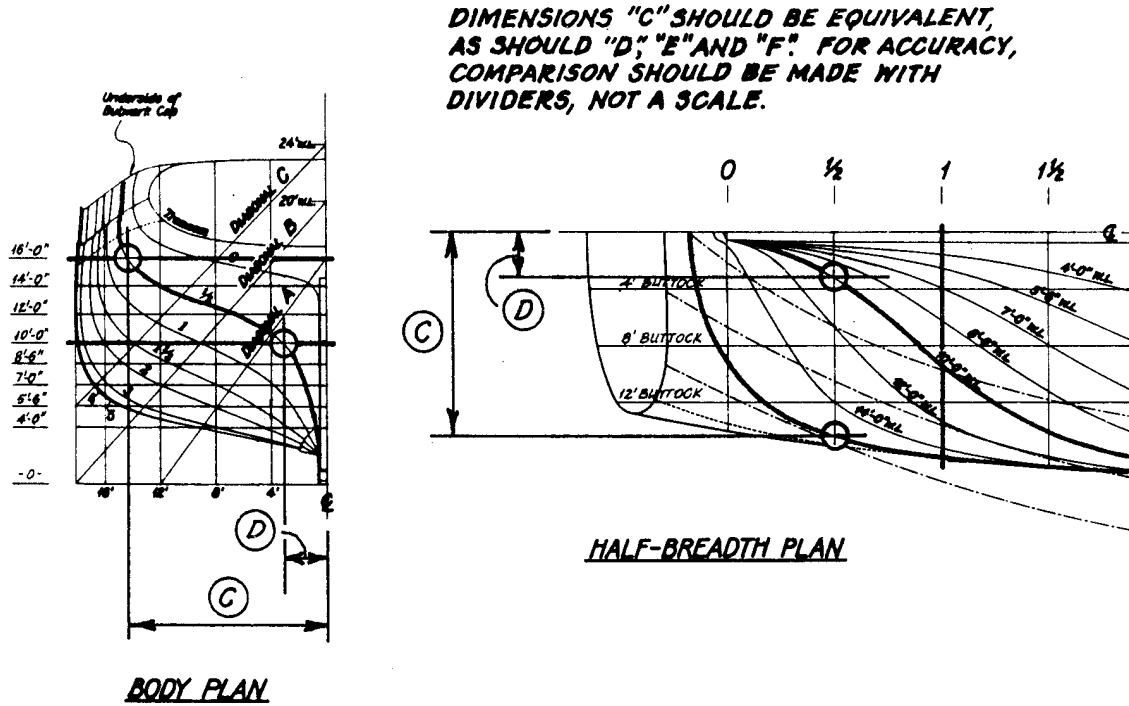

Fig. 4.6.40
Agreement Between Half-Breadth Plan and Body Plan
(section and water line intersections)

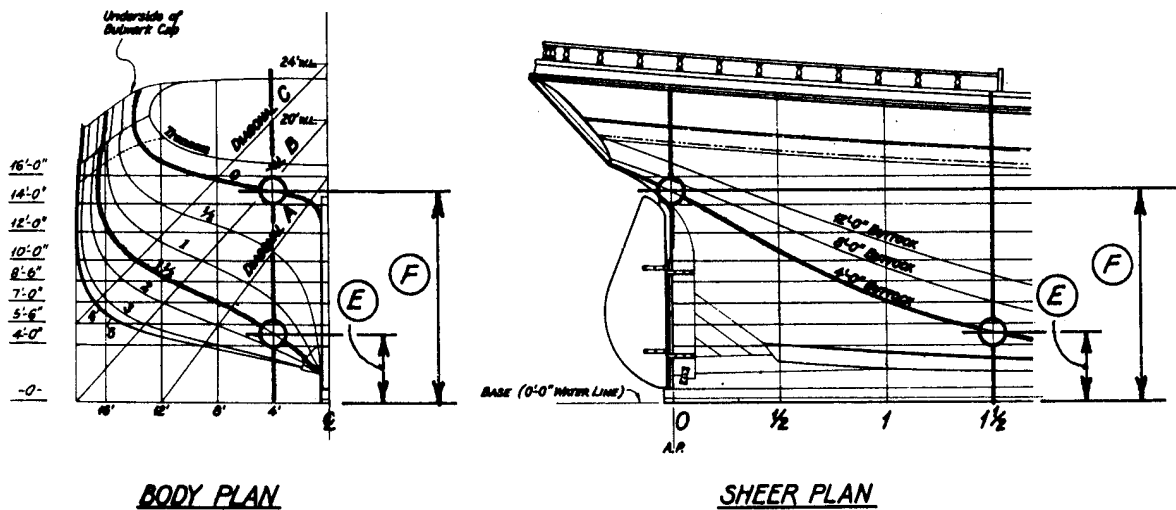

Fig. 4.6.41
Agreement Between Sheer Plan and Body Plan
(section and buttock line intersections)

CONSTRUCTION DRAWINGS

General Remarks. Construction drawings get you into the "nuts and bolts" of a vessel. To record the large numbers of details lying in a vessel you must rank them in order of importance by significance (historical, structural, etc.) and plan an orderly set of views that will present and interpret them most clearly to someone who has never seen your vessel before. General arrangement views (plans, profiles, sections) will give the overall relationship of parts. Details focus on specific things of interest. In some cases, specialized drawings such as shell expansions, isometric views, assembly or exploded views, diagrams, or forms of technical illustration may be necessary to fully document the significant aspects of a vessel. Even when money or time is very limited, significant details should be drawn (at the very least as field notes with measurements), and general arrangement drawings, which give the details their context, should not be omitted in favor of details. Significant details should always be covered by photography. Because construction drawings are by nature far more detailed and varied than lines drawings, it is much harder to give specific guidance in this or that case. In many instances, the vessel itself will settle options because of what you have to do to draw it. The drawing examples (Section 4.7) should prove helpful also. As with lines drawings, you may in some cases discover existing construction drawings of a vessel which could be used as base drawings for further recording work, or which may be traced or photocopied. As with any older documents, such drawings should be scaled and checked against the vessel itself and against the scale indicated on the sheets. Distortions arising from changes in the drawing sheets, or from reproduction processes, should be carefully looked for. Use of such drawings in any way should be fully cited on the new drawings, and any variations made by the team documented in notes.

Scale. As with lines plans, a scale of 1/4" to the foot is a common choice for construction drawings--it is large enough to show some

detail, small enough to keep a drawing reasonably compact. Larger vessels may take two or more sheets to show an inboard profile or deck plan at this scale, but in terms of the information content of the drawing it is better to use multiple sheets instead of reducing the scale in an attempt to keep the entire vessel on one sheet. However, if you are drawing a steel vessel, steel structural members have a much finer cross section than wooden members. Since steel structural members won't show up well unless drawn at a very large scale (3/8" or 1/2"), this may allow you to draw plans and profiles at a fairly small scale (3/32" or 1/8"), saving typical structural details for drawing at large scales (1", 1-1/2", etc.) on other sheets. In many cases, if a vessel is drawn at small scale, other drawings will have to be made to show significant portions of the vessel at larger scales where the significant features can be studied. You may find it an even trade-off (or better) in terms of labor to draw the entire vessel at a larger scale, thereby reducing the need for extra detail sheets even though you will produce more sheets for the general arrangement drawings.

Deck Plans and Inboard Profiles. Probably the first construction drawings to be done on your project will be overall deck plans and profiles. In any case, you will discover that the deck plans and inboard profile need to be worked out *together*, sometimes even in conjunction with sections. Many features in a deck plan cannot be drawn without projecting them from an inboard profile, because they are inclined to the drawing plane (see Fig. 4.6.42). Measurements fore and aft on deck are required to construct the inboard profile, as well as triangulations taken in vertical planes parallel to the plane of the profile. Heights taken with a transit can be invaluable for quickly laying out the curves of the main deck and lower decks; they can also be used to double-check features located by triangulation. In some cases, you may need to make a profile of the starboard (or even port) sides of deckhouses, or the profile of the inboard sides of the bulwarks. Be sure to remember that features beyond the section plane

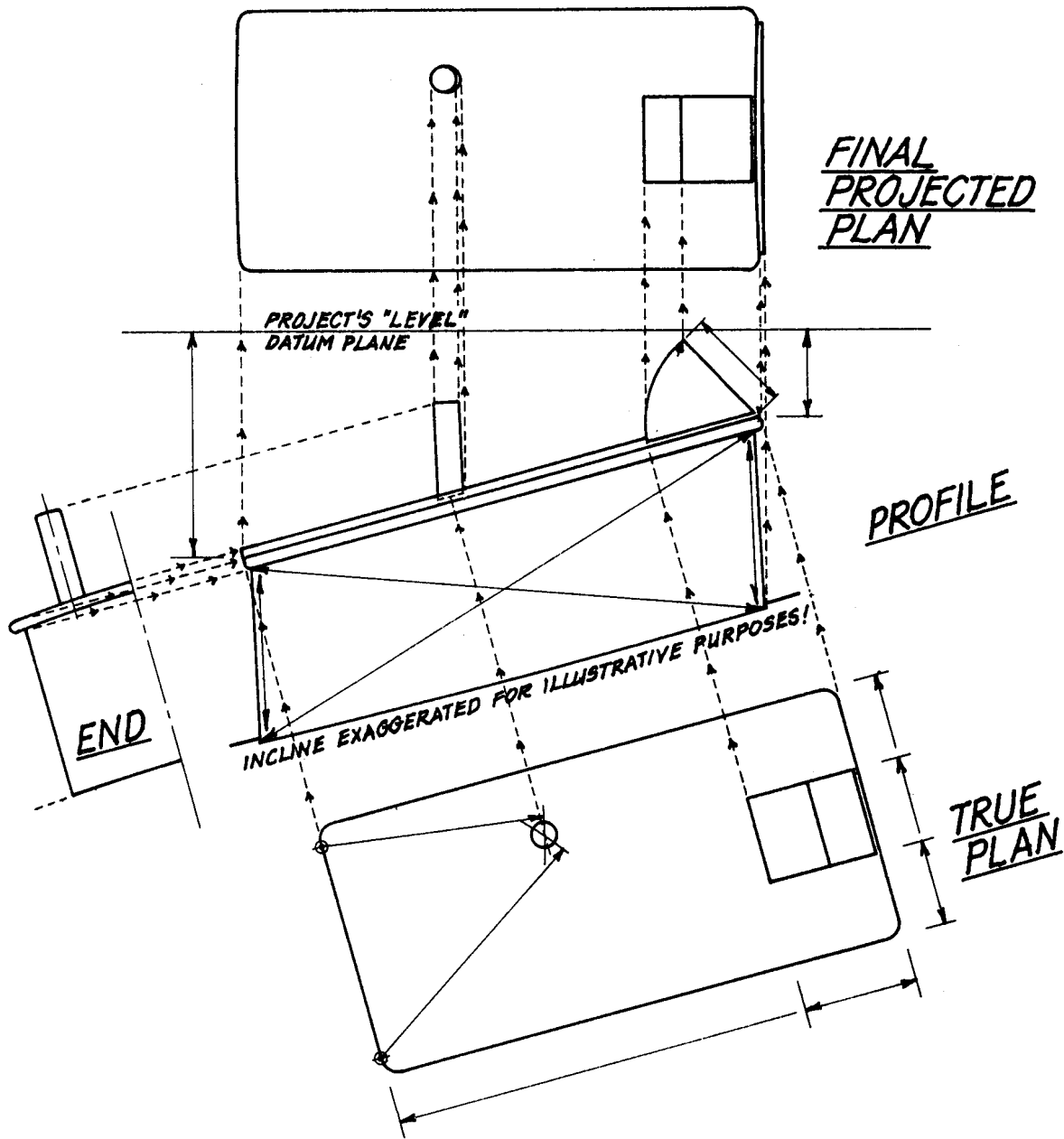

Fig. 4.6.42
Plans and Profiles Working Together

Taken from Steam Schooner WADAWA, Historic Structure Report, Sheet 12 of 13, by Tri-Coastal Marine, Inc. for National Park Service

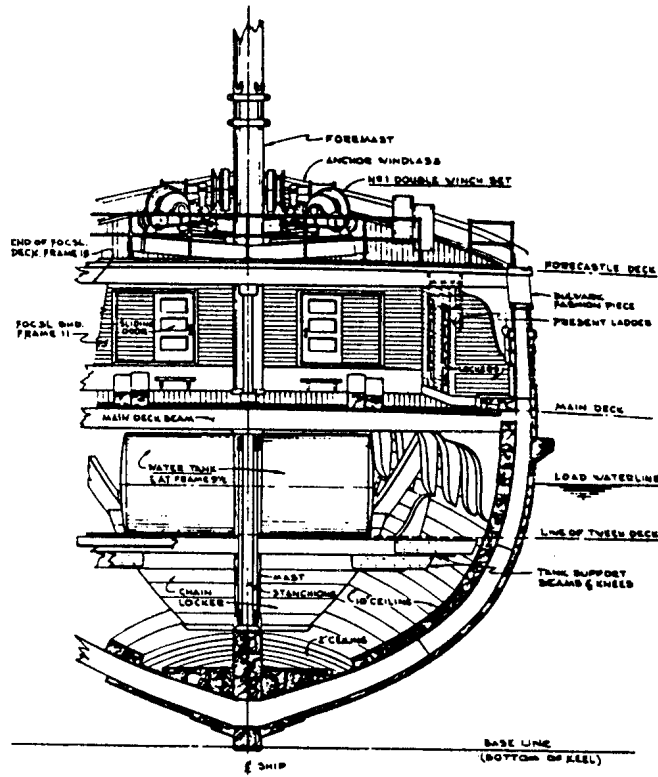

Fig. 4.6.43
Section with Projected Background

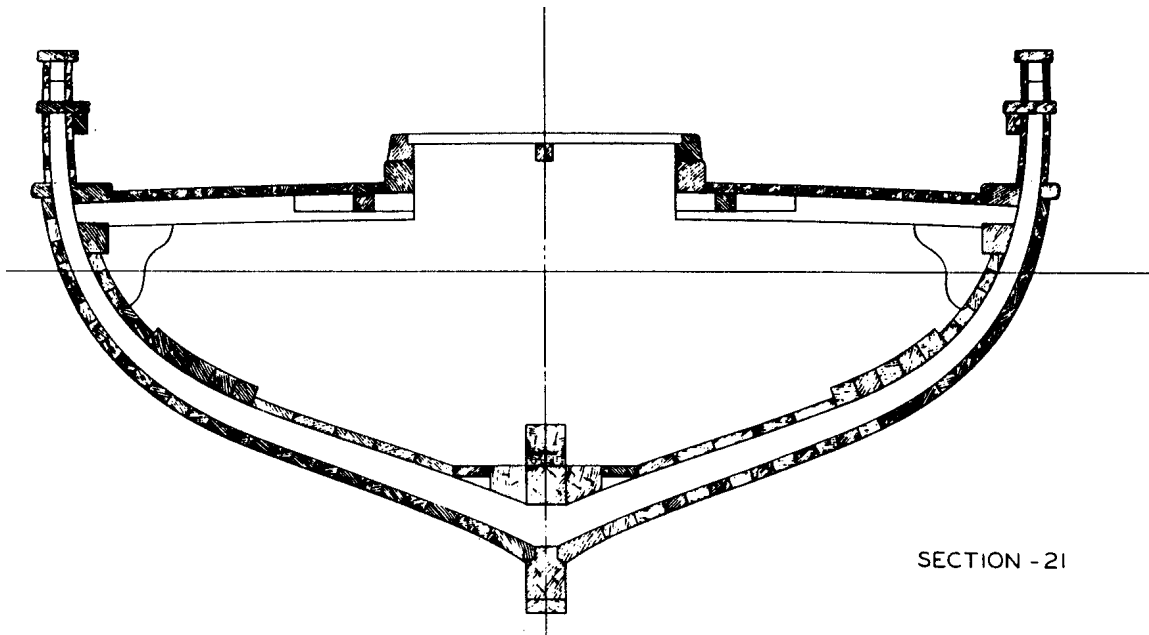
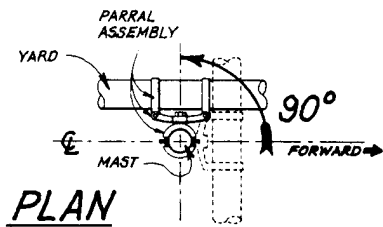

Fig. 4.6.44
Section without Projected Background

Taken from LOUISA HARRISON, HANNS No. 16-42 Sheet 5 of 9

of the inboard profile may not project squarely into the section plane. Cambered deck beams are a case in point. Though an inboard profile is taken at the center plane of a vessel, some features (such as masts, ladders, anchor winches, etc.) which lie in the center plane are not sectioned in order to preserve clarity. Features that lie beyond the section plane (such as the port side bulwark) should be shown in the inboard profile

appears in an inboard profile above the main deck also shows up in outline or location in an outboard profile, and there is no point in plotting the same things twice. As with the inboard profile, the outboard is almost always drawn with the bow to the right. HAER prefers that a full profile be shown, rather than one drawn only above the floating water line. Paint colors should be recorded with their Munsell color numbers though some investigation may be



Yards with Parrels are drawn with yards braced parallel to ship's centerline, pivot point centered at mast. Mast is drawn in starboard profile.

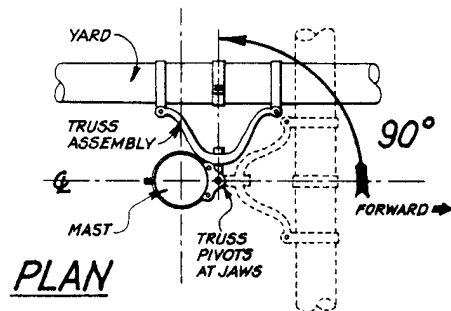
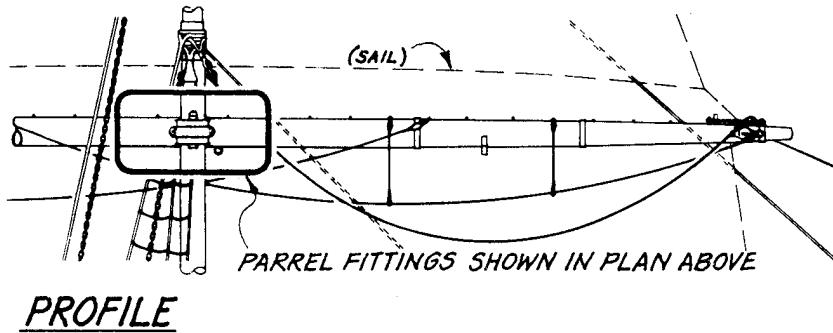

Yards with Cranes or Trusses are drawn with yards braced parallel to ship's centerline, pivot point forward of mast at the hinge. Mast is drawn in starboard profile.

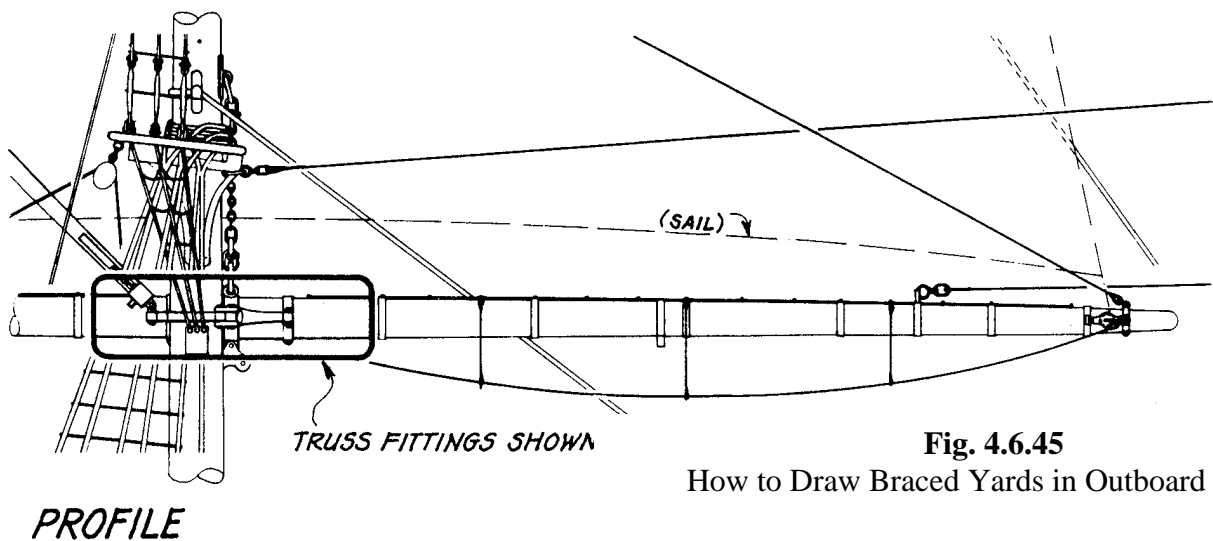

Fig. 4.6.45
How to Draw Braced Yards in Outboard Profile

of sail construction, the team (in consultation with the review team) should determine the relative significance of these features. You may end up drawing them, or recording them photographically, or treating them in detail in the historian's report.

Mast Elevation. Detailed sets of measured drawings of sailing vessels may include mast elevations to show the general arrangement of rigging and hardware on each mast. The masts are usually drawn in profile, with yards braced up sharp, though views drawn looking forward or aft are also possible. On square-rigged vessels, you can take advantage of symmetry and omit the yards, sails, and rigging to one side of each mast. In fore-and-aft views, you might take advantage of symmetry and draw standing rigging alone on one side, running rigging on the other. Same scale or larger sections of each mast may be needed at various levels to show details (trestle trees, trusses, etc.). Fore-and-aft mast elevations of square-riggers may be combined with hull sections to economize on drawing sheets. All parts should be labeled.

Rigging Diagrams. Many people find rigging a mystery, and a nicely executed profile, accurate to the last brace, does nothing to relieve their confusion. On vessels of great significance, it may be worth developing a drawing sheet which explains in simplified terms the various rigging systems used aboard your vessel, especially if the drawings are likely to be used for exhibit or sold as posters to visitors. (These are arrangements to be worked out with project cosponsors, the review team, and vessel owner.) Pin rail diagrams and other sorts of illustrations can do a lot to unscramble for others what may be second nature to you, as well as provide invaluable information to present and future generations about how your vessel was actually rigged and operated.

Mechanical Propulsion. Engines, boilers, and auxiliaries should most certainly appear in deck plans and inboard profiles of vessels carrying such equipment. It is not necessary to section this machinery in an inboard profile, nor is it likely that you will need to do large-scale, detailed drawings of it, unless it is extremely unusual in nature. It may be possible to locate existing engineering drawings of engines and other machinery in published sources, trade catalogs, museum collections, and the like. What should appear in your drawings are notes covering the mechanical specifications of such equipment--builders, patent numbers and dates, model numbers, serial numbers, sizes, pressures, horsepower, capacities, RPMs (revolutions per minute), etc. Much of this can be treated in detail in the historian's report (the drawings should carry notes to this effect). Formal photographic coverage should be thorough.

If major components are missing, HAER suggests they be restored in the drawings when adequate information is available to do so. Photography can record the existing incomplete conditions.

Equipment. Production of detailed drawings of equipment will depend largely on the equipment's significance. Particular views will depend on the nature of the equipment (is it a small boat? an anchor windlass? a bilge pump? a piping system? an industrial process?). Remember to include any available particulars or specifications (see Notes, p. 4.6.29 and Machinery, p. 4.6.33).

Shell Expansions. A shell expansion amounts to a Mercator map of a hull surface. It is produced by plotting measurements taken in section planes along the hull surface to planking seams, plate joints, and other features. Measurements and plots are usually started at the rabbet line.

Once points have been plotted, lines are faired in which correspond to the plank seams, etc. This is not a drawing one can use to scale dimensions for plates or planks, since distortion has been introduced by flattening out a compound surface. Such drawings may be necessary to record specialized features and fastening patterns, or for use in planning repairs.

Details. If drawn separately, specialized construction details, hardware, fittings, turnings, decorative features, etc., should be grouped carefully on sheets by type, location on board the vessel, and scales of the views. Avoid crowding views together, but try to take advantage of symmetry if you need to save space or avoid an awkward-looking composition. Notes on significance, materials, etc., should be included as necessary.

Isometrics and Perspectives. Occasionally it will save space and confusion to draw certain features or details as isometrics or perspectives instead of relying on two or three orthogonal views. Some features which have a complex internal structure can be usefully interpreted by drawing them in an exploded view, or as an assembly with certain parts cut away in an instructive manner (see Fig. 4.6.46). Views such as this are more technical illustrations than measured drawings, but they should be carefully constructed projections based on measurements or traced over photographs rather than refined freehand drawings. Naturally, labeling and notes are needed to describe what is being shown.

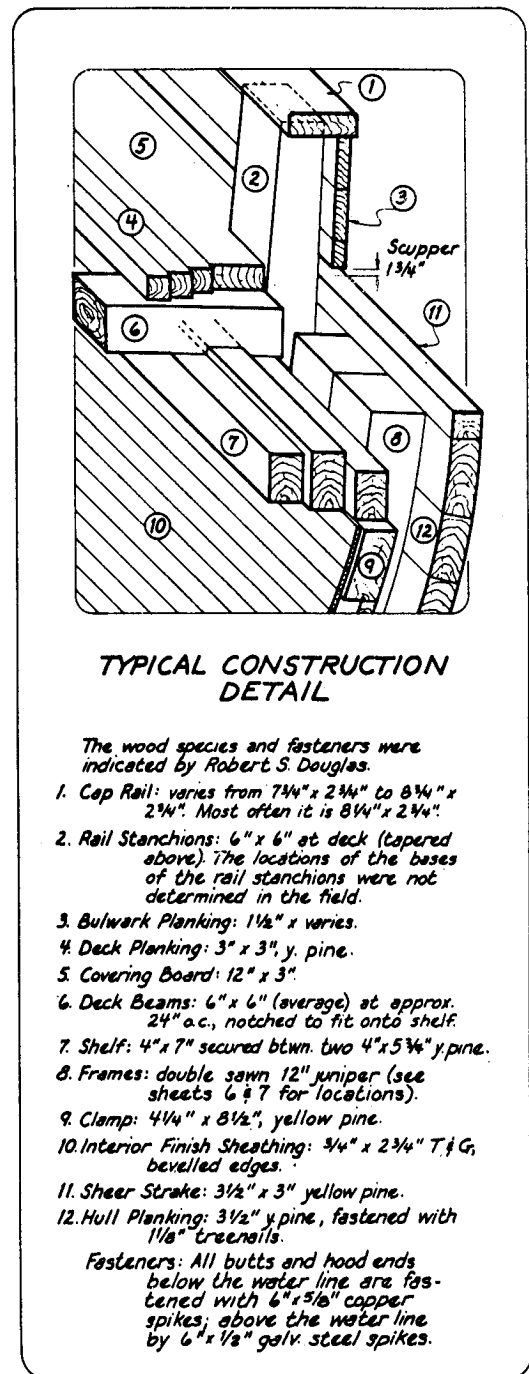

Fig. 4.6.46

Axonometric "Peel-Away" View of Construction

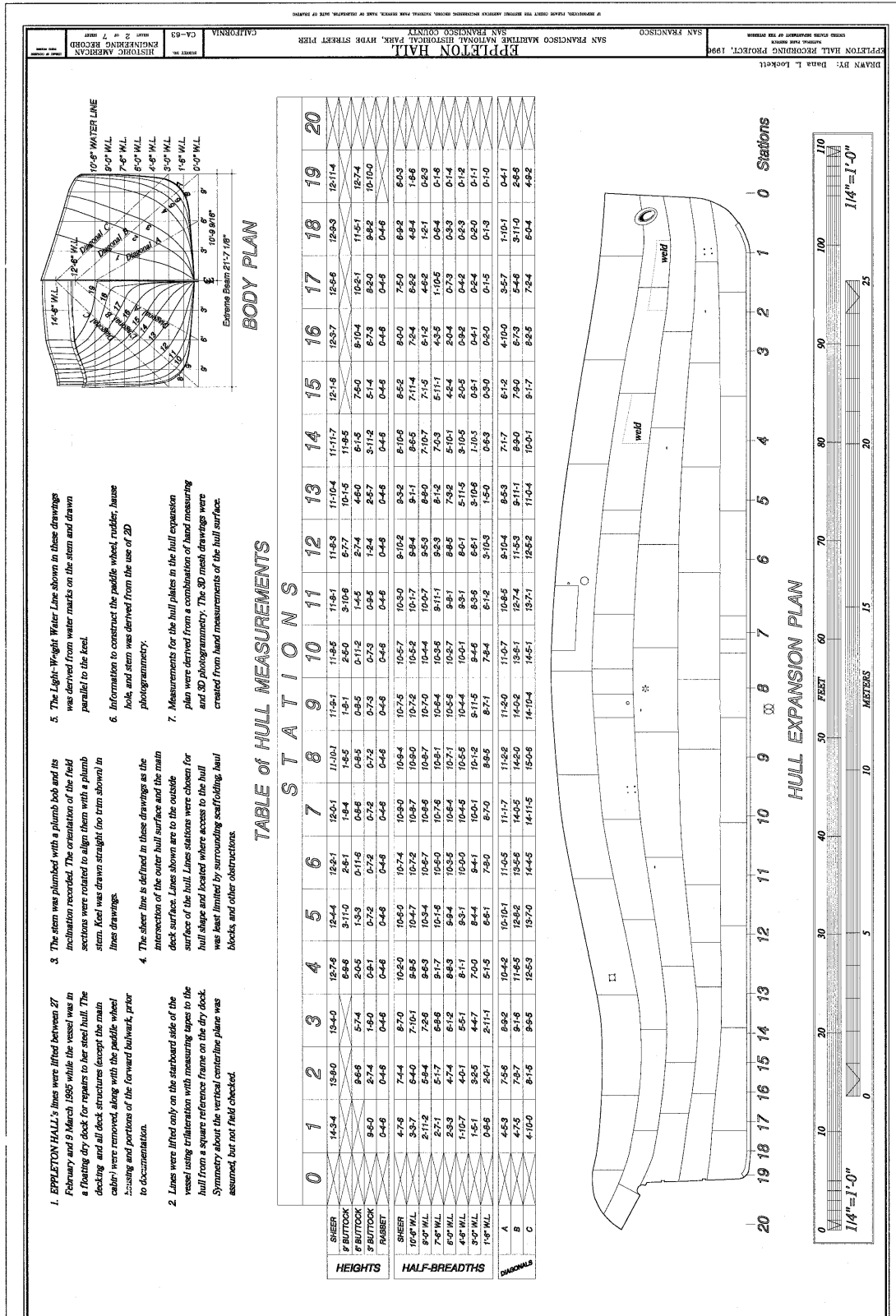

Fig. 4.6.47
Shell Expansion

HABS/HAER GUIDELINES for RECORDING HISTORIC SITES and STRUCTURES using COMPUTER-AIDED DRAFTING (CAD)

1.0 INTRODUCTION

1.1 Objectives. These guidelines address the application of the *Secretary of the Interior's Standards and Guidelines for Architectural and Engineering Documentation* to the use of computer-aided drafting (CAD) software in the production of two-dimensional HABS/HAER measured drawings. This document is intended as an addendum to *Recording Structures and Sites with HABS Measured Drawings* (hereafter referred to as the HABS Guidelines) and *Recording Historic Structures and Sites for the Historic American Engineering Record* (hereafter referred to as the HAER Guidelines). Reference should be made to the HABS and HAER Guidelines for any issues not addressed in this document.

2.0 FIELD RECORDS

2.1 Digital Records. A hard copy plot or printout of any digital data or image used in the field recording process should be included as part of the field records. (Examples include scanned raster images, digital photographs, and lists of electronic surveying data points.)

2.2 Photogrammetric Images. A print of any photogrammetric image used in the field recording process, along with dimensional information pertinent to control points in the image, should be included as part of the field records.

3.0 MEASURED DRAWINGS

3.1 CAD Software and File Formats.

HABS/HAER does not require or recommend the use of any particular CAD software nor of any specific file format.

3.2 Layer Naming Conventions.

HABS/HAER does not require the use of any specific layering system. HABS/HAER recommends the use of a layering system based on the *CAD Layer Guidelines* developed by the American Institute of Architects (AIA), as adapted to the specific needs of a particular project.

3.3 Line Weights. Line weights should be configured to correspond to those described in Section 5.3 of the HABS Guidelines or Section 4.9 of the HAER Guidelines.

3.4 CAD Fonts. HABS/HAER recommends the use of a sans-serif or Roman serif font for drawing text. Only one font should be used per project. All fonts should be TrueType (TTF) format.

4.0 FINAL PLOTS

4.1 Sheet Materials. Final plots must be made on 4 mil(0.004") thick drafting film (also known as mylar), with a single- or double-matte finish. For plotters using cut sheets, sheets preprinted with either a HABS or HAER border are available from the HABS/HAER office. For roll plotters, digital versions of the HABS and HAER title blocks, in either DXF or AutoCAD DWG formats, are available from the HABS/HAER/HALS office, or may be

downloaded from the HABS/HAER/HALS website.

4.2 Pen Plotters. Plotters using pens which contain ink which meets the standards of the Library of Congress for archival stability, such as those listed in Section 1.4.3 of the HABS Guidelines or Section 4.9 of the HAER Guidelines, may be used for making final plots of HABS and HAER drawings.

4.3 Inkjet Plotters. Plots made by inkjet plotters do not meet the standards of the Library of Congress for archival stability, and therefore must never be used for making final plots of HABS and HAER drawings.

4.4 Electrostatic and Laser Plotters. Plots made by electrostatic and laser plotters (also known as LED plotters) meet the standards of the Library of Congress for archival stability, and therefore may be used for making final plots of HABS and HAER drawings.

5.0 DIGITAL FILES

5.1 Submission of Digital Files. Neither the HABS/HAER/HALS office nor the Library of Congress currently maintains an archive of CAD files, however, PDF files are made from the CAD files and converted to TIFFs for access on the Libraries web site “Built In America”. Therefore the submission of such files, as an accompaniment to the final plots, is recommended. It is recommended that a copy of CAD files are sent with their field notes. This should be accompanied by a hard copy document which lists and describes the software used, the individual file names, the layering system, the corresponding line weights, and any other information pertinent to digital aspects of the project. (Keep in mind that the Library of

Congress does not consider magnetic media such as diskettes and tapes to be archival.

Thus the Library makes no guarantees that

files submitted on such media will be able to be retrieved in the future.)

DRAWING EXAMPLES

Introduction. The selection of drawings and drawing fragments in this section has been collected from a number of sources. Each drawing is accompanied by comments to assist the recorder in applying HAER guidelines for laying out and inking HAER drawings. These comments address both what to do and what *not* to do.

At the time these guidelines were first prepared in 1988, HAER had only a small number of completed vessel recording projects in its collection that could be used for illustration. As a result, examples were selected from the Historic American Merchant Marine Survey (HAMMS) and from the works of Howard I. Chapelle, both collections preserved at the Smithsonian Institution. An informative history and evaluation of the HAMMS program, its goals, methods, and results, appears in a master's thesis by James Peter Warren (see Section 4.7 for a complete citation). Many of these examples have been replaced by completed HAER documentation, including some archeological projects.

Many comments have been made on others' efforts, either recommending certain methods or suggesting ways these models may have to be adapted or improved to meet HAER's criteria. HAER's suggestions and comments are not intended as adverse criticisms of its predecessors. Much of this early work should be held in great regard, especially considering some of the

constraints in time and money the recorders were working under. HAER's remarks on graphics, layout, and documentary discipline come from thousands of man-years of recording experience (albeit in nonmaritime resources) and from continuing attempts to improve its methods. HAER's goal is not only to make precise drawings and records, but to produce these in such a way that they are as informative, thorough, and attractive as possible. HAER is a public agency producing public records, and hence must go beyond what may seem to be sufficient in some cases. Aside from strict documentary concerns, HAER drawings should be able to do double and triple duty as publishable graphics (from posters to scholarly articles), exhibit and educational materials, base drawings for maintenance and restoration, fund-raising materials, and the like. HAER anticipates that its records will be a significant force in spreading and cultivating the public's interest in America's historic vessels, a goal that we believe the maritime community shares.

The following section is broken down into several groups of drawings, roughly in the order of views in a drawing set (see p. 4.6.2): lines, profiles, inboard profiles, deck plans, sections, and details. HAER will be glad to receive any comments and suggestions for improving this (or any other) section of the guidelines; improvements will be incorporated in succeeding editions.

LINES DRAWINGS

Fig. 4.7.1

Market Schooner *SYLPH*

This drawing was originally made as a book illustration, not intended as documentation in the HAER sense. Pretending that it was for HAER (for the sake of example), we offer the following observations:

Layout

Combination of outboard profile and sheer plan works well in this case.

Drawing is compact, and relationships of views are easily understood.

Scale is a very useful length for checking reductions, scaling with dividers, etc.

Deck plan should be drawn separately from half-breadth plan, not dotted over it.

Notes on vessel's description, history, colors, and lines plans would have been better collected into one area of the sheet (e.g., lower left) rather than scattered about the drawing.

Linework is elegant, but too light; structure of the vessel (e.g. rails, masts, deckhouses) should receive heavier line weights. The scale is the strongest graphic element.

Lettering for notes is clean and legible, but title lettering is much too small and light

Documentation

Note that sections are spaced for sake of shape, not hydrodynamic calculations.

There is no clear indication what this drawing is based on. Seeing that the drawing was made 55 years after the ship sank, was it based on older drawings, a model, a half-model, photographs, or someone's field notes? Are any parts educated guesswork? The reader has no clue.

On what basis are the color identifications made?

How accurate are the drawings? One could assume $\forall 1/2"$ since the moulded beam is given as 17'-1", but on what is such precise dimensional information based?

Table of Hull Measurements (sometimes called a "Table of Offsets" or "Table of Ordinates") is missing.

LINES DRAWINGS

Figs. 4.7.2 through 4.7.4

Schooner **WAWONA**

These drawings were part of a 1985 HAER documentation project.

Layout

Lines plans were spread out over three sheets to accommodate documentary notes and show lines at a scale (1/4" = 1'-0") somewhat commensurate with accuracy of field work.

Symmetry used to show half-breadth plan and deck plan together on same centerline.

Sheer/half-breadth plans have been laid out so that reproductions of the two sheets may be easily spliced together with extremely little loss or repetition of information.

Delineation

Lines and structure read strongly, though they tend to be overridden graphically by the notes column and the scale.

Lettering is clear and bold; lettering for view titles is heavier and larger than that for labels, and labels stand out against linework.

Notes are organized into columns; labels on linework for buttocks and water lines are grouped visually; arrows are used for clarity.

Diagonals are drawn on half-breadth plan, but with interrupted lines so that confusion with waterlines is prevented.

Documentation

Extensive notes record intent of the drawing, assumptions, relevant field and drafting room procedures, definition of sheer line, and sources for reconstructed billethead and scrollwork; omitted features are noted. Estimated dimensional errors in field work and in the drawing are also noted.

It should have been plainly noted whether lines are to inside or outside of planking, though this might be inferred from notes on field methods.

"Deck Plan" would have been better labeled "Rail Plan" for all we see.

Blank boxes in Table of Offsets should have a diagonal line drawn through them to show that omission is intentional, not an oversight (even though user can check body plan or scale from it).

1897

TABLE OF OFFSETS

ALL DIMENSIONS BELOW ARE GIVEN IN FEET, INCHES, AND EIGHTHS OF AN INCH
(See Notes 1 and 2)

HEIGHTS ABOVE BASE	STATIONS														
	0	1/2	1	1 1/2	2	3	4	5	6	7	8	8 1/2	9	9 1/2	10
UNDERSIDE OF BULKHEAD CAP	22-0-4	21-4-5	20-10-6	20-5-6	20-1-0	19-7-0	19-2-2	18-7-2	18-2-4	17-7-6	17-2-8	16-7-10	16-2-12	15-7-14	15-2-16
SHEER	19-2-4	17-6-2	16-11-4	16-6-5	16-2-2	15-8-4	15-4-4	15-0-4	14-6-4	14-2-4	13-8-4	13-4-4	13-0-4	12-6-4	12-2-4
16" BUTT.	17-0-0	14-0-0	11-3-2	8-10-0	7-0-2	5-0-4	4-6-4	4-2-4	3-8-4	3-4-4	3-0-4	2-6-4	2-2-4	1-8-4	1-4-4
8" BUTT.	15-0-0	12-5-0	9-5-4	7-0-4	5-4-4	4-0-2	3-9-0	3-8-0	3-7-0	3-6-0	3-5-0	3-4-0	3-3-0	3-2-0	3-1-0
4" BUTT.	14-11-2	10-9-0	7-1-6	4-10-0	3-9-6	3-1-2	2-11-0	2-11-4	2-11-4	2-11-4	2-11-4	2-11-4	2-11-4	2-11-4	2-11-4
RABBIT	2-11-0	2-4-4	2-5-0	2-1-6	—	—	—	—	—	—	—	—	—	—	—
BULKHEAD CAP	13-6-4	14-7-4	15-4-2	15-11-0	16-5-2	17-1-0	17-5-4	17-7-4	17-9-4	18-0-0	18-0-0	18-0-0	18-0-0	18-0-0	18-0-0
SHEER	13-5-4	14-11-4	15-10-0	16-5-0	16-10-6	17-6-4	17-10-4	18-0-0	18-0-0	18-0-0	18-0-0	18-0-0	18-0-0	18-0-0	18-0-0
26" WL	13-7-2	—	—	—	—	—	—	—	—	—	—	—	—	—	—
24" WL	13-11-0	14-9-0	15-5-6	15-11-6	16-5-4	—	—	—	—	—	—	—	—	—	—
20" WL	13-3-6	15-0-0	16-3-4	16-7-4	17-2-6	17-7-2	18-2-6	18-7-2	19-2-6	19-7-2	20-2-6	20-7-2	21-2-6	21-7-2	22-2-6
18" WL	9-1-0	14-4-4	15-8-2	16-5-4	16-10-6	17-0-0	17-5-4	18-0-0	18-5-4	19-0-0	19-5-4	20-0-0	20-5-4	21-0-0	21-5-4
16" WL	1-0-2	12-0-2	15-2-4	16-5-0	17-0-2	17-5-4	18-0-0	18-5-4	19-0-0	19-5-4	20-0-0	20-5-4	21-0-0	21-5-4	22-0-0
14" WL	0-6-4	6-7-0	13-2-4	15-8-2	16-10-4	17-0-0	17-5-4	18-0-0	18-5-4	19-0-0	19-5-4	20-0-0	20-5-4	21-0-0	21-5-4
12" WL	0-6-4	3-2-0	9-1-6	13-11-6	16-0-4	17-6-0	18-0-0	18-5-4	19-0-0	19-5-4	20-0-0	20-5-4	21-0-0	21-5-4	22-0-0
10" WL	0-6-4	0-9-4	1-6-4	2-3-0	4-5-0	7-10-2	9-3-4	9-3-4	9-3-4	9-3-4	9-3-4	9-3-4	9-3-4	9-3-4	9-3-4
8" WL	0-6-4	0-9-4	1-6-4	2-3-0	4-5-0	7-10-2	9-3-4	9-3-4	9-3-4	9-3-4	9-3-4	9-3-4	9-3-4	9-3-4	9-3-4
6" WL	0-6-4	0-9-4	1-6-4	2-3-0	4-5-0	7-10-2	9-3-4	9-3-4	9-3-4	9-3-4	9-3-4	9-3-4	9-3-4	9-3-4	9-3-4
4" WL	0-6-4	0-9-4	1-6-4	2-3-0	4-5-0	7-10-2	9-3-4	9-3-4	9-3-4	9-3-4	9-3-4	9-3-4	9-3-4	9-3-4	9-3-4
HALF-STEERING	0-6-4	0-9-0	—	—	—	—	—	—	—	—	—	—	—	—	—
DIAGONALS	A	2-22	6-9-0	9-7-0	11-9-0	13-3-0	14-8-6	15-0-4	15-0-4	14-11-2	14-7-4	13-3-2	11-9-0	9-5-4	6-0-6
B	6-6-2	10-6-6	13-6-4	15-10-4	17-7-6	19-7-4	20-2-4	20-3-0	20-6-6	19-3-2	16-3-2	16-3-2	14-5-6	11-5-6	7-6-4
C	11-6-4	14-11-4	17-7-0	19-9-0	21-4-2	23-11-6	23-10-0	23-11-6	23-9-2	22-5-4	19-2-0	16-6-2	13-1-4	8-10-4	3-9-6

HALF-BREADTHS

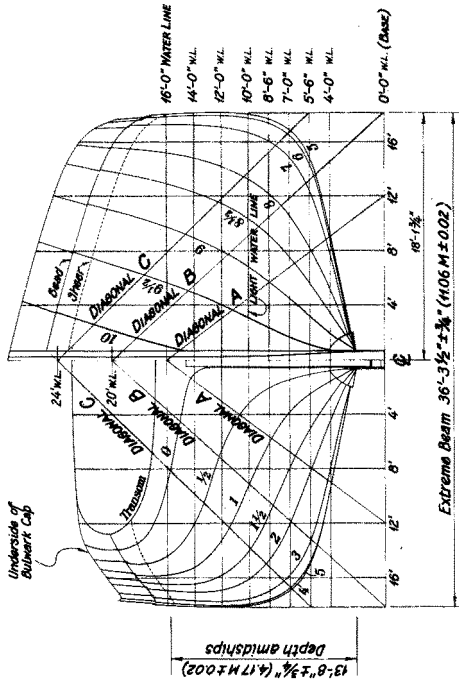

BODY PLAN



7. The base line (plane) is set at the bottom of the worm shoes.
8. A "sheer line" is defined in this drawing as the intersection of the general hull surface and the main deck surface (not the top of the covering board or waterway).
9. Maximum camber of the main deck was probably about 3 1/2" originally (between Stations 4 and 5), after taking into account the current (1985) 1" upward deflection of the deck beams amidships. (Maximum camber better define the hull at the bow and stern.
10. Bow extension is 4-5-6 forward of Station 10, at the intersection of the outer rabbit line and stem-head (underside of bowsprit).
11. Stern extension is 10-0-4 aft of Station 0, at the aftermost extremity of the transom planking (at centerline of the ship).
12. Bow and stern extensions of buttocks and water lines were not tabulated since they may be scaled from the half-breadth and Sheer Plans, Sheets 3 and 6.

1. Example: 18-7-7 = 12'-7 7/8"
2. Dimensions scaled from Body Plan to 1/4" scale inch; Body Plan accurate to ± 3/8" scale inch.
3. All offsets are to outside of side planking 40' top of deck planking.
4. The 40-foot water line was assumed to have been the original light water line.
5. Station spacing of 46'20" was produced by dividing WAWONA's length at the 40-foot water line (152'-0" ± 1 1/2") by 10. Four half-stations were added to

Fig. 4.7.2

1897

NOTES

1. This lines drawing depicts MAHONA after an "on paper" removal of all hull distortions present in 1985. Hogging and twisting (whether due to age or construction error) were corrected in the belief that MAHONA'S builders intended her to be construction frames. It is believed that the lines at right closely represent the 1897 originals.
2. In "straightening out" the hull, it was assumed that the shape of the body plan sections had remained nearly unchanged since MAHONA'S construction due to the exceptionally good condition of the hull below the water line and the in-fact 9'-culling from the turn of the bilge changes in the section shapes due to hogging forces (as transmitted through the centerline) to the deck beams. The 1897 sheer line thus has about 42" more spring than the 1985 sheer line.
3. In plotting the "original" buttocks and water lines, tangents were drawn to the hogged keel on the existing condition drawings at points where the 1985 field section planes intersected the keel. The angle between the tangent and section plane at each station was maintained when the ship's lines were redrawn with the keel straightened out. (Tangents were estimated by eye, not plotted mathematically.) Copies of these interim plots are contained in the project field records for reference.
4. Buttocks and water lines between field stations 3 and 10 were re-plotted with field sections tilted to port, 1 inch in 16 feet. This usually produced symmetrical sections and the most correlation (port and starboard) between lines. Lines at other stations were plotted with the sections tilted only as far as necessary to achieve close, same results. Only the starboard lines are shown since symmetry is assumed.
5. The base line (plane) used in this drawing is set at the bottom of the worm shoe and corresponds with existing draft marks on the hull. Water lines shown are relative to this base line, not the field base line or water lines used in the station condition drawings (1985) on sheets 2 to 4.

(continued on Sheet 6)

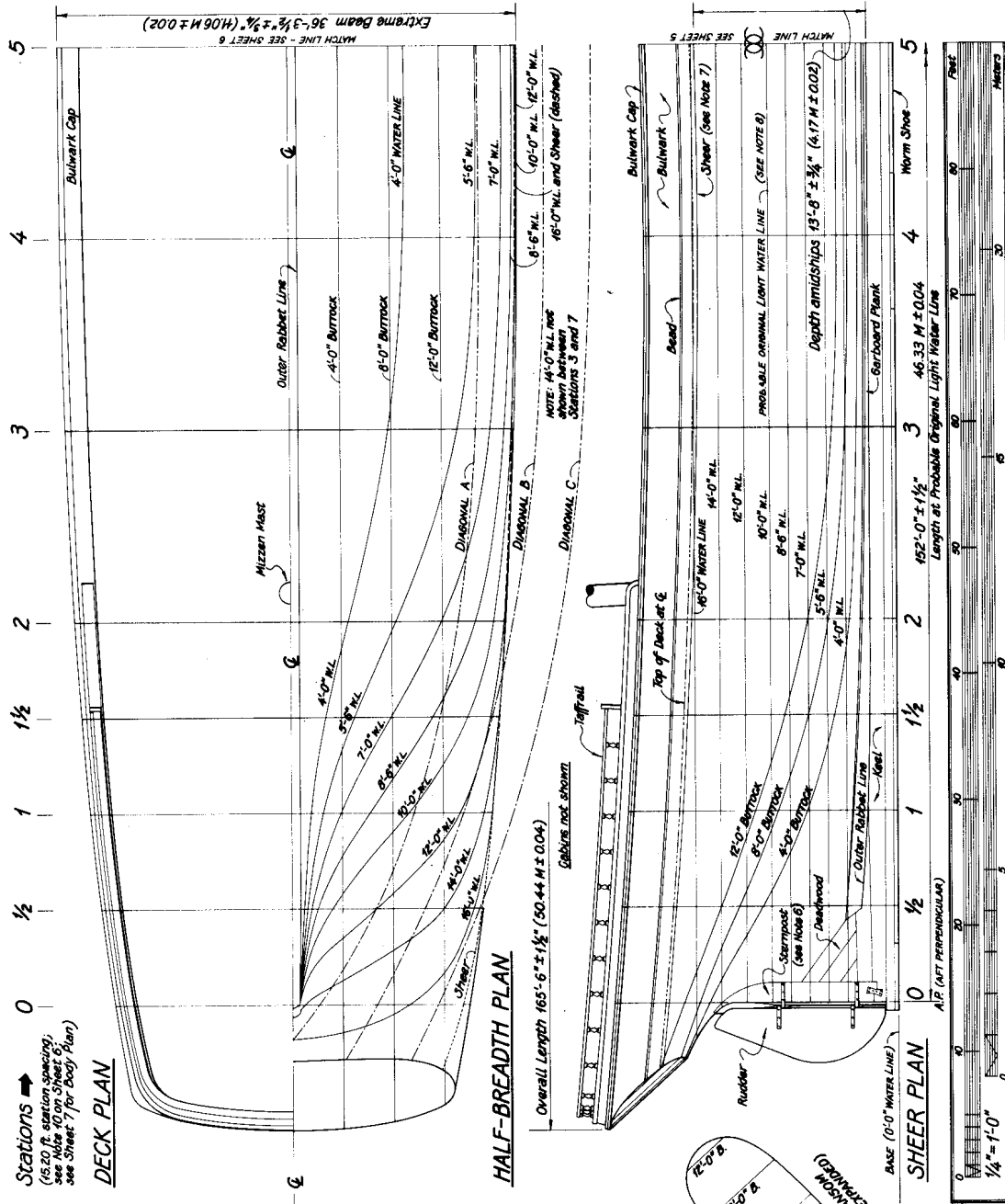

Fig. 4.7.3

OUTBOARD PROFILE

Fig. 4.7.5

Martha's Vineyard Cat

This sheet by Howard I. Chapelle contains a lot of detail and is attractive graphically. Pretending that it had been submitted as HAER documentation, however, it falls short in ways outlined below from HAER's perspective. A photographic survey and written report would mitigate this somewhat.

Layout

Sheet is neatly organized, though tables, body plan, and midship section appear somewhat crowded. In lieu of attempting to put everything on a single sheet, HAER would have suggested using two sheets. (Intrusion of gaff into table border at top of sheet is a nice touch, however.)

Delineation

While lettering is clear and legible, lettering for drawing views (e.g., "Construction" on midship section) are not large enough or strong enough to stand out. Title "Martha's Vineyard Cat" does not stand out above all other lettering--hard to find.

Delineation of profile is elegant, but too light relative to lettering and tables.

Documentation

Note is made that the boat's lines were lifted (presumably by Chapelle) rather than taken from a model or someone else's work. However, no record appears regarding overall condition of vessel, recording methods used, accuracy, problems encountered (if any), other personnel involved, etc. No note is made as to boat's builder or place she was built. No note indicates whether even an unsuccessful attempt was made to discover these things.

Scantlings are given on midship section, but no notes as to materials. Dimensions of spars and sails are given, but not size of lines. Some construction information is given verbally here and there, but no attempt is made to be more comprehensive graphically (details of rudder post trunk or mast step). Some of these things could be covered photographically, but much is left for the user to assume or look up without helpful references in the drawing. If some details are generic, this should be clearly stated, as well as where these details may be found. (Remember "User Smith" in the year 2335 A.D. How many 20th century catboats or books on their construction will survive for him to study?)

A separate, detailed deck plan would be preferred over the dotted version superimposed on the half-breadth plan.

Fig. 96, Martha's Vineyard Cat, American Small Sailing Craft Collection. Delineated by Howard I. Chapelle. Reproduced courtesy of the Smithsonian Institution.

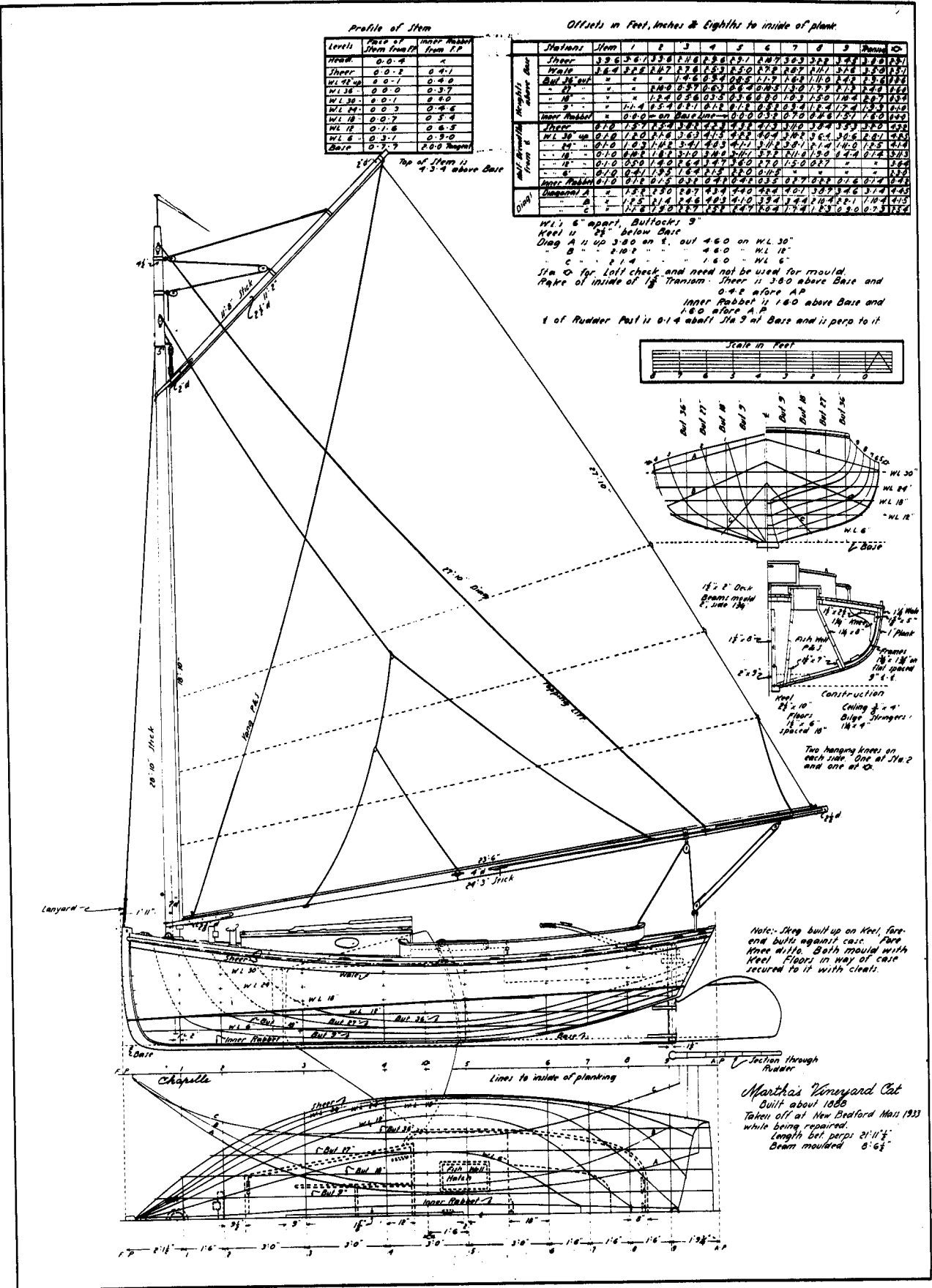

Fig. 4.7.5

OUTBOARD PROFILE

Fig. 4.7.6

Ship *BALCLUTHA*

Layout

The sheet is laid out well. The ship fills the sheet, with the scale providing a visual anchor. Notes are contoured to the shape of the drawing.

Delineation

This profile is well delineated. Line weights are appropriate and well balanced. Note that spars and hull were delineated with heavier lines than details, running rigging, etc.

Note the use of shadowing to help distinguish spars from lines.

Some deck features with fine details bleed together in reduction.

The graphic scale runs the length of the ship, making scaling with dividers an easy matter.

Documentation

The information source for features which are no longer extant (sails and rigging) has been verbally documented on the drawing.

It is also noted that most of this drawing was produced by tracing reductions of other drawings without stating clearly that they are HAER drawings. No accounting is given as to the accuracy of the reductions or the final view presented.

The national ensign should be four times larger than shown. Since the sails were reconstructed, perhaps ship's flags should have been displayed as well (house flag at the main peak, courtesy flag at the fore peak, and call letter flags from the mizzen royal mast).

The present color scheme is noted, but not pinned down with Munsell numbers for the grey and red colors cited. There is a reference in the drawing for historical colors.

Overall length and height should have been shown.

OUTBOARD PROFILE

NOTES

- A) The standing rigging depicted shows what was in place on the BALCLUTHA ca. 1988. The running rigging is based on information from BALCLUTHA's rigging crew and Mast-Top & Rigging the Clipper Ship & Ocean Liner, Harold A. Underhill, Brown, Son and Ferguson, Ltd., Glasgow, Scotland.
- B) BALCLUTHA's hull colors in 1988, cap, rail down, black; white (high-lighting the false supports), grey, and red. Some painted hull features have not been shown. For a description of historical color schemes see sheet 37.

The masts and spars, hull outline and many deck features were traced from reductions of the 3/8" = 1'-0" drawings.

BALCLUTHA's poop deck was extended forward 68' in 1911.

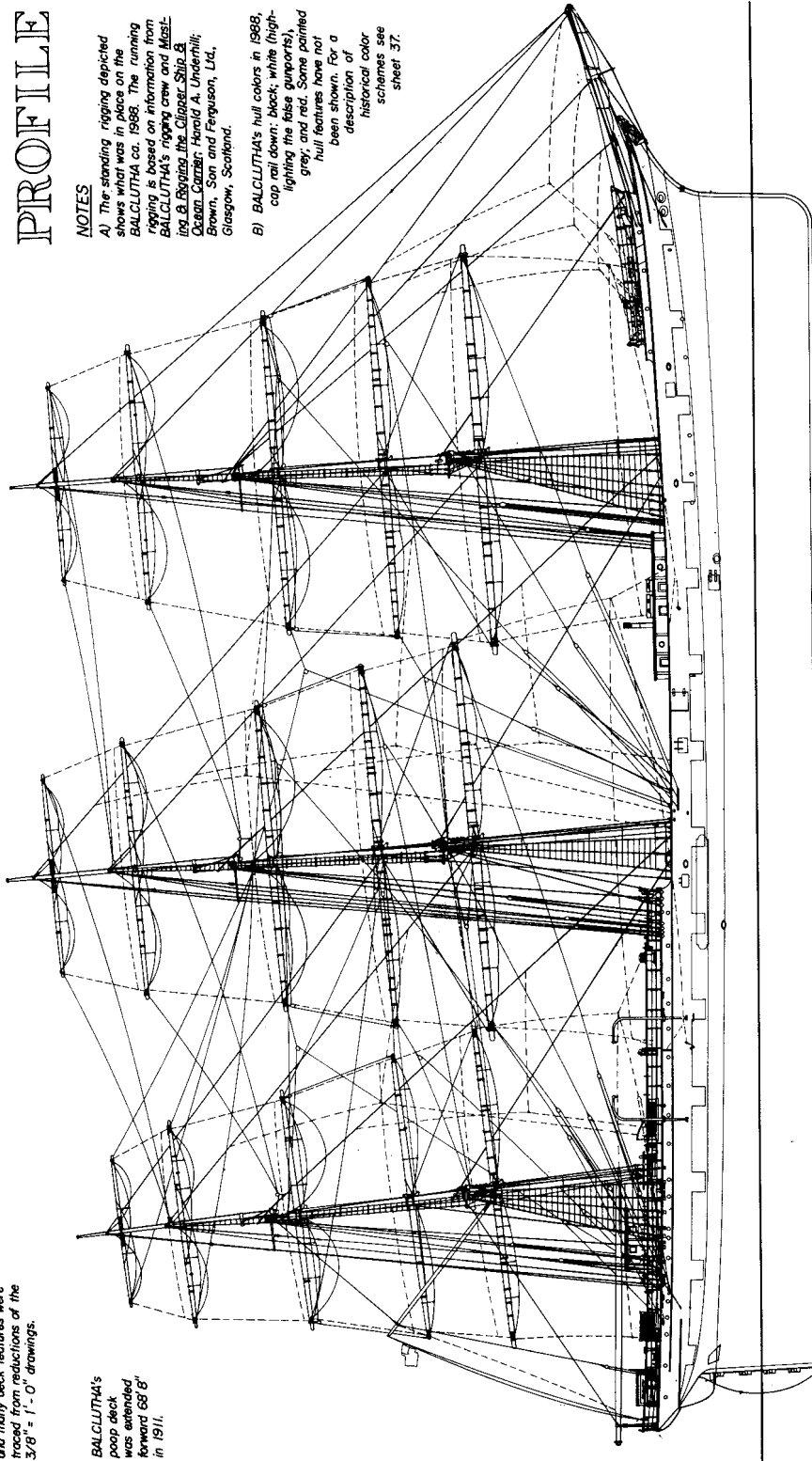

Scale: 3/32" = 1'-0"

Scale in Feet

Scale in Meters 1:128

Fig. 4.7.6

OUTBOARD PROFILE

Figs. 4.7.7 and 4.7.8

Bugeye *LOUISE TRAVERS*

Layout

Two sheets were used for this view in order to present the vessel at a reasonable scale and leave space for documentary notes. The two sheets are designed so that reproductions may be spliced together with little loss, repetition, or rearrangement of information.

Note that the radio mast and antenna break the drawing sheet border. This is an acceptable way to show small elements that would otherwise not quite fit inside the borders. (Linework should never extend beyond the trim line or into the title block, however.)

Delineation

The drawing reads well due to use of a variety of line weights and shadowed lines.

Sizes and weights of lettering permit easy reading. Notes are organized into columns. Labels are almost never made over linework, and arrows are used to make positive identification of labeled features.

Documentation

Notes clearly state that the view does not show the existing conditions at the time of field work (1986), but that decayed and missing features have been reconstructed and refers to the HAER record photographs for actual conditions. The decision to show "corrected" views depends on the scope of the project. In this case, the vessel was deemed unrestorable, and the HAER documentation would become the only detailed record of the vessel. In such a case, "corrected" views make sense, especially when field photography and HAER record photographs show the vessel's actual condition. On restoration projects, "as-is" or existing condition (uncorrected) drawings may be necessary in order to guide planning and restoration efforts.

Some notes are keyed to tags in drawings.

The notes on sheet 6 continue on sheet 7, but sheet 6 does not indicate this.

Error tolerances in overall dimensions are indicated as well as a note describing a discrepancy between the drawing and field measurements.

Other sheets are noted where further information can be found.

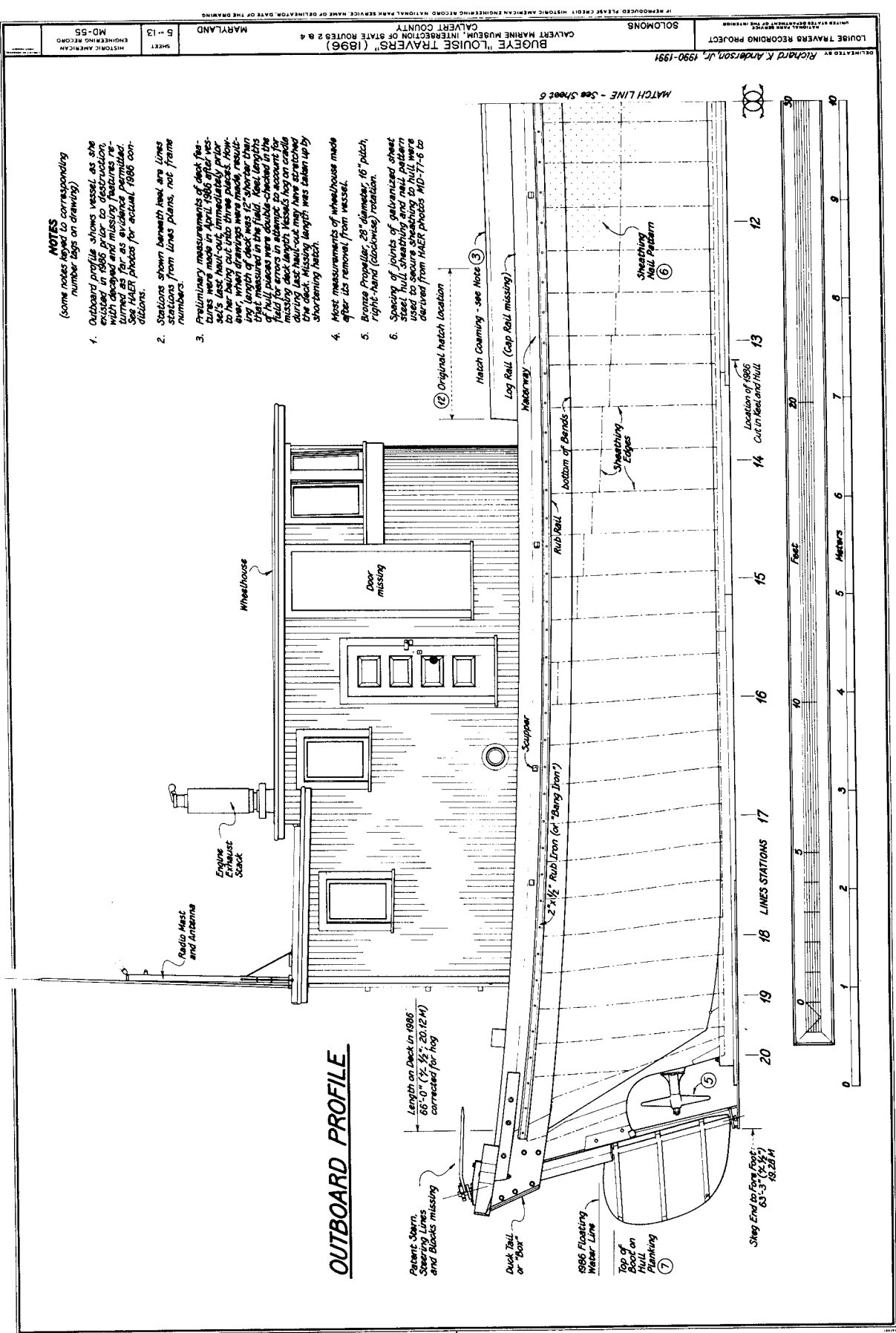

NOTES
(some notes refer to corresponding number logs on drawings)

1. Outboard profile shows vessel as she existed in 1986 prior to destruction with decayed and missing features identified as actual 1986 condition. See HAER photos for actual 1986 conditions.
2. Stations shown beneath keel are Lines numbers.
3. Preliminary measurements of deck features were made in April 1986 after vessel's last haul-out, immediately following the 1986 destruction. However, when drawings were made, resulting length of deck was 12" shorter than that measured in the field. Keel lengths of hull pieces were double-checked in the field for accuracy. It is noted that the hull deck length vessel's hog on cradle during last haul-out may have stretched the deck. Missing length was taken up by shortening hatch.
4. Most measurements of wheelhouse made after its removal from vessel.
5. Bronze Propeller, 28" diameter, 16" pitch, right-hand (abovestern) rotation.
6. Spacing of joints of galvanized sheet steel hull sheathing and nail pattern used to secure sheathing to hull, were derived from HAER photo MD-77-6 to

OUTBOARD PROFILE

Fig. 4.7.7

OUTBOARD PROFILE

Fig. 4.7.8

Bugeye *LOUISE TRAVERS*

(see previous comments)

LOUISE TRAVERS RECORDING PROJECT
 RICHARD K. ANDERSON, JR., 1990-1991

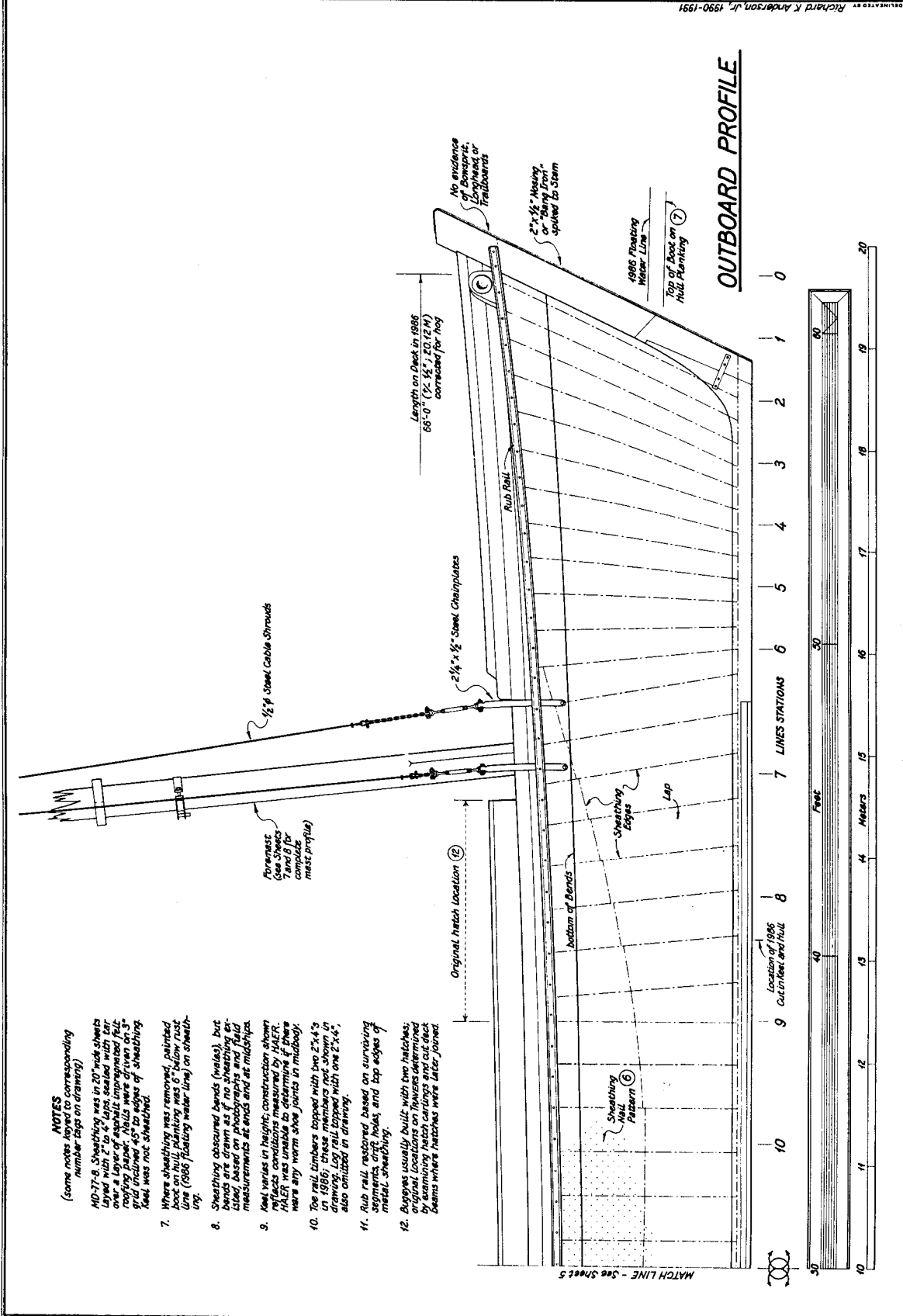

- NOTES**
(some notes keyed to corresponding number tags on drawing)
- NO. 7-8. Sheathing was in 20' wide sheets with a 1/2" overlap. The sheets were covered over a layer of asphalt impregnated felt roofing paper. Nails were driven on 3" grid inclined 45° to edges of sheathing. Keel was not sheathed.
 - Where sheathing was removed, painted boot on hull planking was 6" below rust line (1986 floating water line) on sheathing.
 - Sheathing obscured bernds (wales), but bernds are drawn as if no sheathing existed, based on photographs and field measurements at ends and at midships.
 - Keel varies in height; construction shown reflects conditions measured by HAER. HAER was unable to determine if there were any worm shoe joints in midbody.
 - The rail timbers topped with two 2"x4's in 1986; these members not shown in drawing. Log rail topped with one 2"x4", also omitted in drawing.
 - Rub rail restored based on surviving segments, drift, holes, and top edges of metal sheathing.
 - Burgess usually built with two hatches; original locations on keels determined by examining hatch carlings and out deck beams where hatches were later joined.

Fig. 4.7.8

OUTBOARD PROFILE

Fig. 4.7.9

Tug *LOU CHANDLER*

Layout

This profile is a tight fit on the sheet, but the layout is acceptable. A smaller scale for the drawing would have been necessary if the graphic scale had been longer and larger.

Delineation

This is a good example of a drawing made perfectly flat by the use of a single fine line weight. In all other respects the delineation is flawless--no mismatched curves and tangents, no blobby lines, no overrun or unclosed corners. Even closely spaced parallel lines maintain uniform spacing. This drawing creates an impression of razor-sharp precision.

What would improve this sheet? Heavier lines for edges of major features, or the use of shadowed lines. Blackening in windows, portholes, and lamp lenses might also help make the drawing more three-dimensional, if shadowed lines don't do the complete job.

Documentation

As with previous drawings, this sheet gives a user no means to verify or evaluate what he is looking at, either dimensionally or factually. No verbal dimensions are presented. The graphic scale is too small to use reliably for scaling long dimensions, and the user has no clue whether or not the drawing represents the vessel as she was at the time of recording. The presumption is that the drawing is accurate, but all hand-measured and drawn records are a complex combination of measured features, reasonable assumptions, and selective representation, long before such questions as restoring damaged parts, unfair lines, etc., come into play.

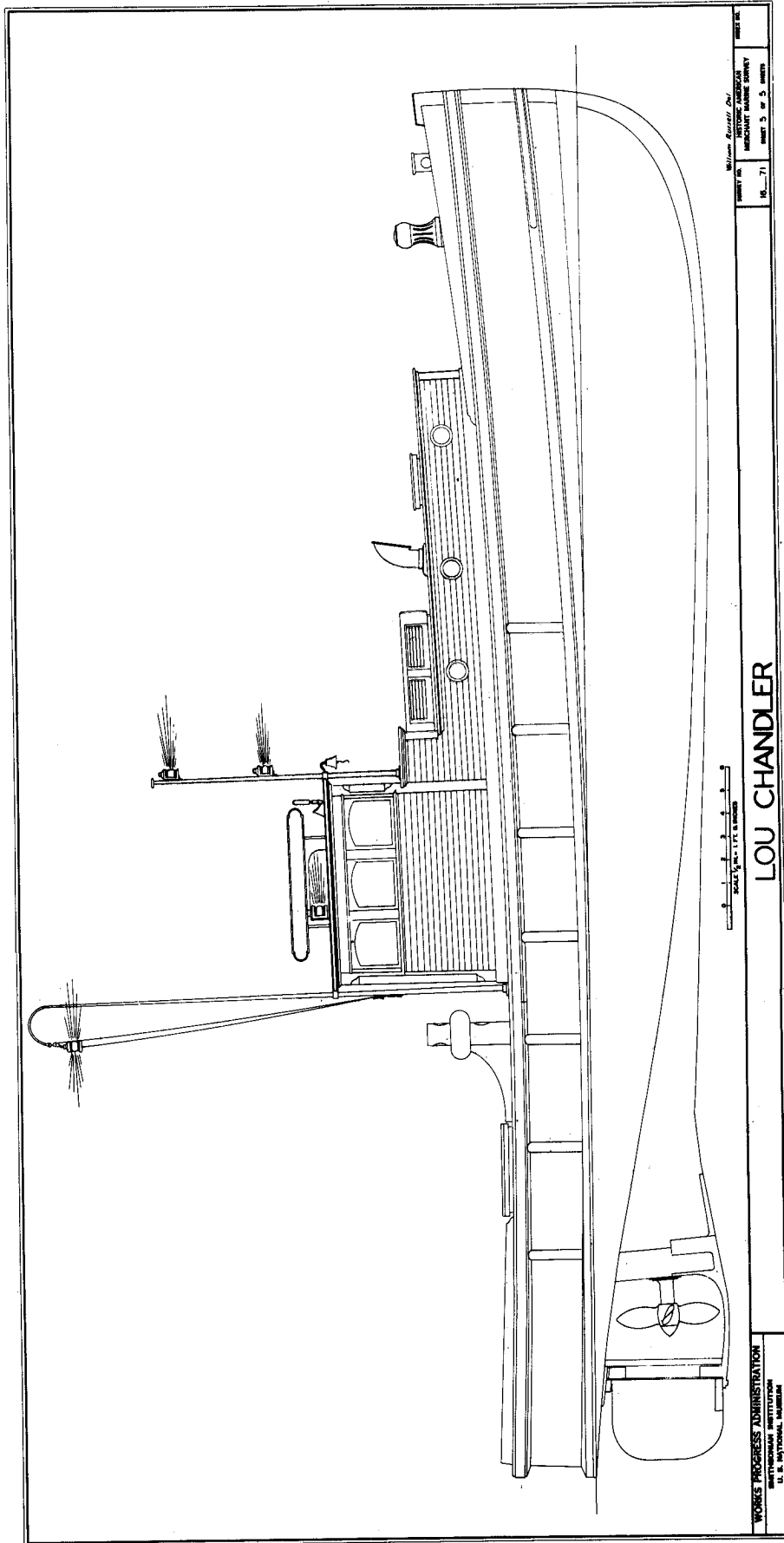

Fig. 4.7.9

INBOARD PROFILE

Fig. 4.7.10

Tug *LOU CHANDLER*

Layout

Very good. Lots of room for notes. There is also room for an extended graphic scale beneath the profile.

Delineation

This is a good example of a very finely rendered profile, though the carefully controlled wood graining obscures the joint lines between adjacent members. While attractive, HAER would not ordinarily sanction the time expenditure for such extensive graining during a field project. Cross-sectioned members must be rendered; rendering of longitudinally sectioned members is optional.

The tug's wooden structure reads well, and line weights employed are satisfactory; however, the engine is too weakly delineated. Stronger line weights and section rendering are needed to make it read as boldly as the hull structure.

Documentation

As with the companion outboard profile of this vessel (Fig. 4.7.10) no parameters are given for approaching this drawing. The size of the graphic scale is inadequate for scaling long dimensions from the drawing, and no dimensions are given as a check against misdrawn features or reproduction distortions. The user doesn't even know if it was recorded to the nearest inch or eighth of an inch.

How did the recorder of this vessel get access to construction details of the stem, deadwood, and floor construction? Is it "standard hull construction"? Whose "standard"? Did he measure her while her hull was being replanked, or just make an educated guess? Did he base the engine section on engineering drawings in the vessel owner's possession, or take the engine apart and measure the pieces? Notes anticipating such questions are critical components in a drawing. As it is, we don't know how much is fact or fiction here, short of an exhaustive analysis of original field records.

No spaces or objects are labeled. Unless a user is well acquainted with vessels, he may not even be able to guess where the chain locker or bunk room are, or even what they were called. There is something under the wheelhouse that *could* be a fuel tank, but the user isn't specifically informed. If the manufacturer of the engine were given (along with other pertinent data), a user might be able to do extra research to obtain further details.

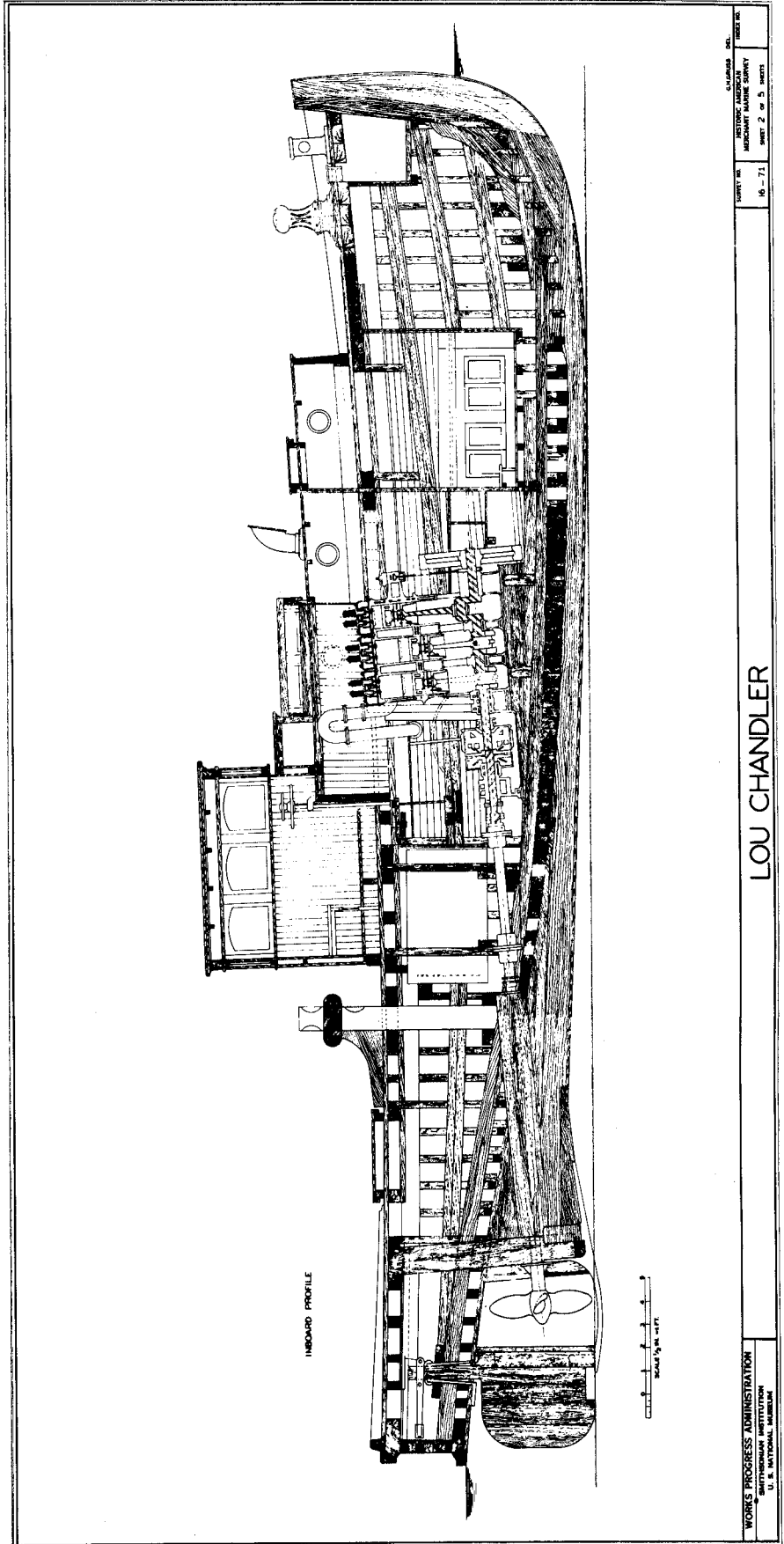

Fig. 4.7.10

INBOARD PROFILE

Figs. 4.7.11 and 4.7.12

Pilot Schooner *ALABAMA*

Layout

Two sheets were used to accommodate this view in order to present the vessel at a reasonable scale and leave space for documentary notes. The two sheets may be easily spliced together with little loss, repetition, or rearrangement of information.

Note that the view consists of three profiles, one above the other; each presents information partially obscured or missing in the others.

Delineation

Drawing reads well due to use of a variety of line weights and shadowed lines.

Wood graining is limited strictly to sectioned members.

Sizes and weights of lettering permit easy reading. View titles are easy to find, notes and scantlings are organized into columns. Labels are almost never made over linework, and arrows are used to make positive identification of labeled features.

Documentation

This view shows a careful attempt to separate existing and historical conditions, accessible from inaccessible features, and information derived first-hand by the field team from that obtained from other sources. Notes point out modification to transom and lack of original rigging. Inaccessible areas are labeled and no speculation made as to their contents. Information derived from other sources (such as hull below the floating water line) is noted.

There are some ambiguities and confusions in the notes and drawings however. For example, Note A doesn't clarify the species of pine used in the deck; it says other wood species weren't determined (in the field? by research?), thus appearing to contradict scantling note 10 where juniper frames are noted. The wood species and fastener sizes were obtained from the vessel owner, but this is not indicated on these sheets.

Even though the vessel has no masts at present (Note B), it would have been useful to dot-in their approximate location using existing historical photographs and surviving structure aboard the vessel (a note referring user to title sheet for a restored profile might have been useful too).

(continued...)

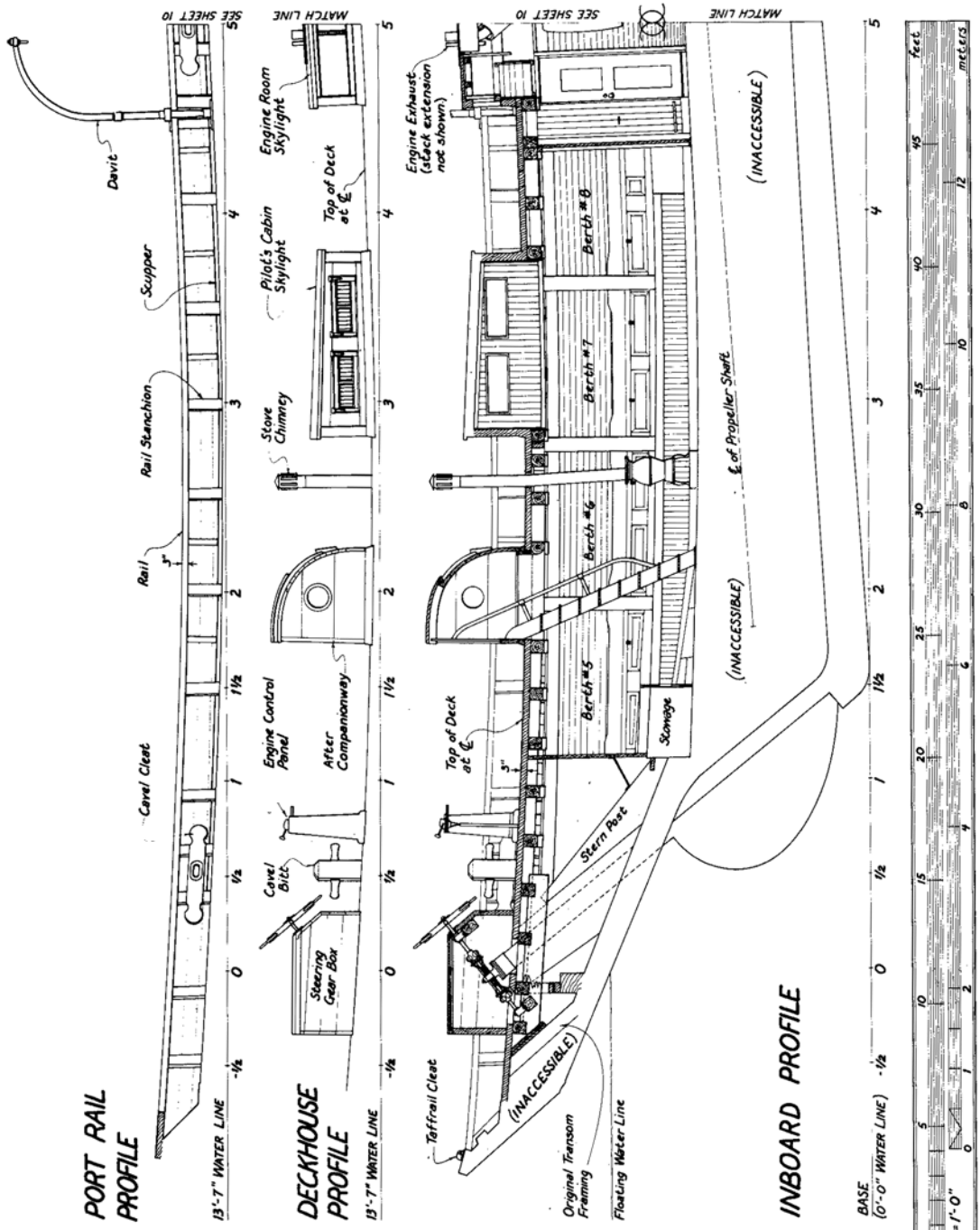

NOTES

- A. No determination was made of the wood species used in construction of the vessel except for the deck (pine).
- B. ALABAMA had no masts or rigging in 1986.
- C. The position of the rail stanchions on the starboard side differ slightly from those on the port side ($\pm 1 1/2"$).
- D. Approximately 3 feet was added to the transom (date unknown) while the vessel served in Mobile, Alabama. This area was inaccessible for measurement.
- E. No observations or measurements were made by HAER below the waterline. Data for the lines, keel and rubler were based on work done by Robert C. Douglas in 1967.
- F. The bilges were filled with ballast and were inaccessible for measurement.
- G. ALABAMA's two engines are Gray Marine Diesel, Model Number 64 HNS, manufactured by the Detroit Diesel Engine Division, General Motors Corp., Detroit, Michigan.

Fig. 4.7.11

(Figs. 4.7.11 and 4.7.12 continued)

Note C is ambiguous about positioning--is it fore-and-aft or athwartships? Extra space for such clarifications in notes could be had by turning Note G into a label and lettering it near the engine on the second sheet.

Major features and equipment are identified, largely with the general public in mind. Those familiar with ships will know a "boat davit" from an "aft companionway" without being told, but part of HAER's mission is educational as well as documentary.

Rabbit line above keel should be identified so that it isn't confused for the top of the keel in the inboard profile. Do the stations shown above the scale correspond to lines drawings? A user new to this documentation wouldn't know if this were the only drawing he had in hand.

Were the berths numbered by the recording team, or were the numbers

assigned based on evidence aboard the vessel?

Are the engines original or not?

Many notes and clarifications might be had from seeing other sheets in this drawing set. Obviously it is impractical and unnecessary to put every possible note on each sheet, but it might be helpful to indicate that other sheets should or must be seen for other data. Error estimations and overall dimensions appear elsewhere, but aren't indicated on these sheets, for example. It is falsely assumed that the user will obtain or see all the sheets if he sees one, although it is conceivable that the inboard profile could be exhibited or published apart from the other sheets.

Graphic scale runs the full length of the vessel permitting scaling from reproductions and reductions. It also provides a check for distortions which may be introduced in reproductions.

SCANTLINGS

1. Cap Rail: varies from 7 1/4" x 2 1/4" to 8 1/4" x 2 3/4" in width. Most often it is 8 1/4" wide.
2. Rail Stanchions: 6" x 6" at deck (tapered above).
3. Bulwark: 1 1/2" thick.
4. Shear Strake: 3 1/2" x 3" y. pine.
5. Hull Planking: 3 1/2" y. pine, fastened w/1/8" treenails.
6. Deck Planking: 3" x 3" y. pine.
7. Deck Beams: 6" x 6" (average) at approx. 2 1/2' o.c.; raftered to fit onto shelf below pine.
8. Carlins: 6" x 6" average.
9. Stringers: 3" x 5"
10. Frames: double sawn 12" lumber frames (see sheets 5 & 6 for locations).
11. Breast hook: 6" thick.
12. Mast Partners: 6" x 6" (approx) at Foremast hole; 9" x 6" and 11" x 6" at Mainmast hole.
13. Lodging knees: 6" thick, arms and throat vary.
14. Shelf: 4" x 7" secured between two 4" x 3 1/4" y. Pine.
15. Clamp: 4 1/4" x 8 1/2" y. Pine.
16. Ceiling: 1 3/4" x 9" - first 4 members below clamp; the rest are 4" x 9 1/2".
17. Interior Finish Siding: 3/4" x 2 1/4" y. G. with bevelled edges.
18. Tween Deck Planking: 1" x 3 1/4" y. G.
19. Fasteners: All butts and hood ends below the water line are fastened with 6" x 5/8" copper spikes; above the water line by 6" x 1/2" galv steel spikes.

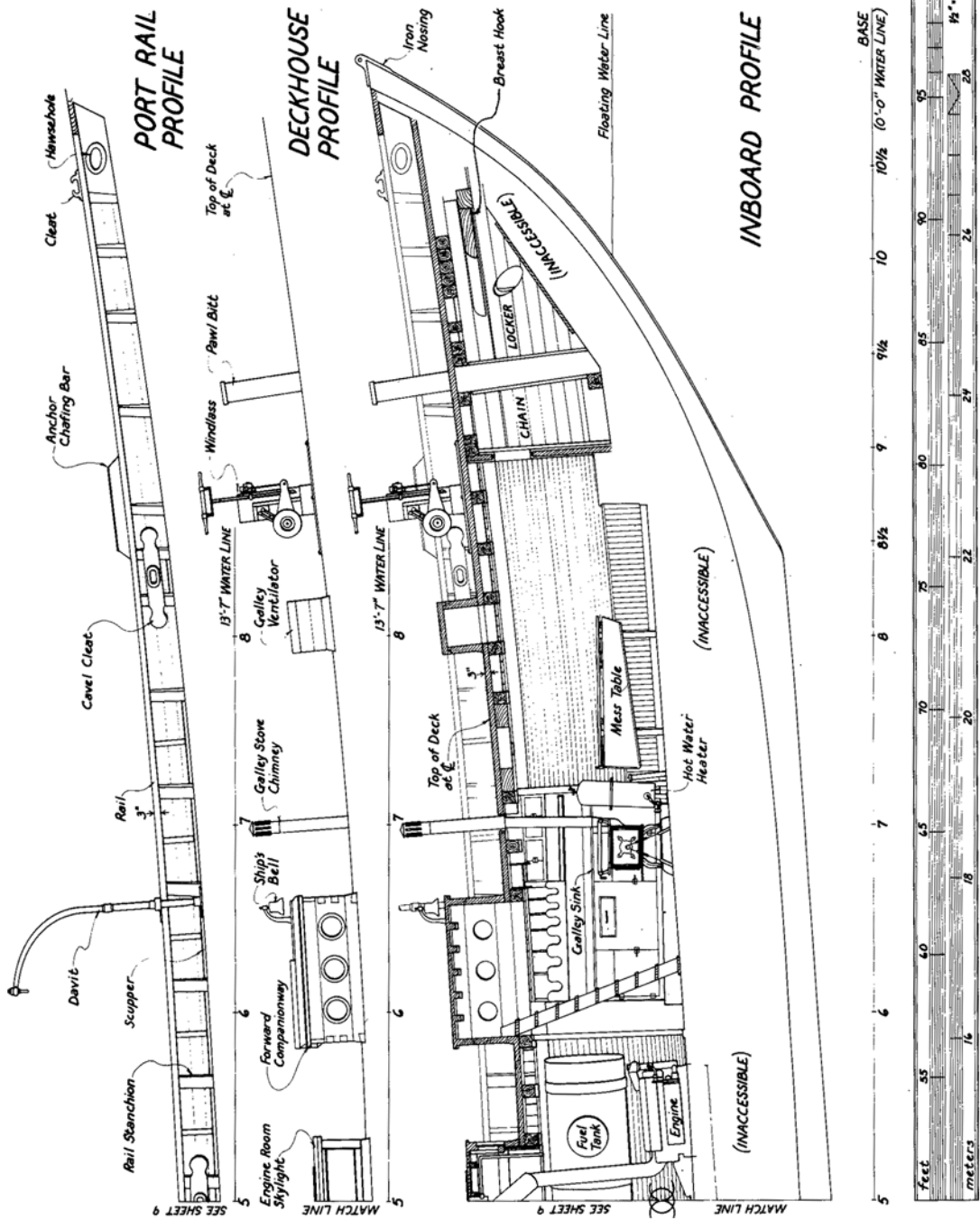

Fig. 4.7.12

INBOARD PROFILE SECTION

Fig. 4.7.13

Ship *BALCLUTHA*

Layout

Sheet is well organized with distinct zones for drawing, notes, graphic scale and location key.

It might have been more useful to place the graphic scale directly beneath the drawing rather than at the bottom of the sheet.

Delineation

Labels were keyed in most places to avoid obscuring linework with lettering.

The variety of line weights distinguishes major structural elements from details. When choosing line weights, consider whether the drawing will be reproduced at a reduced size and copied as this one was-- fine lines sometimes fade away.

Documentation

The notes list assumptions made by HAER, other sources of information, and methods used to obtain measurements.

The location diagram clearly shows where the drawn portion of the vessel fits into the whole.

References to detail sheets and photographs show where to find more information in the HAER documentation package.

Portions of the drawings based on sources other than field measurement have been noted.

The height of the poop deck above the base of the keel has been given, but not that of the 'tween or main decks.

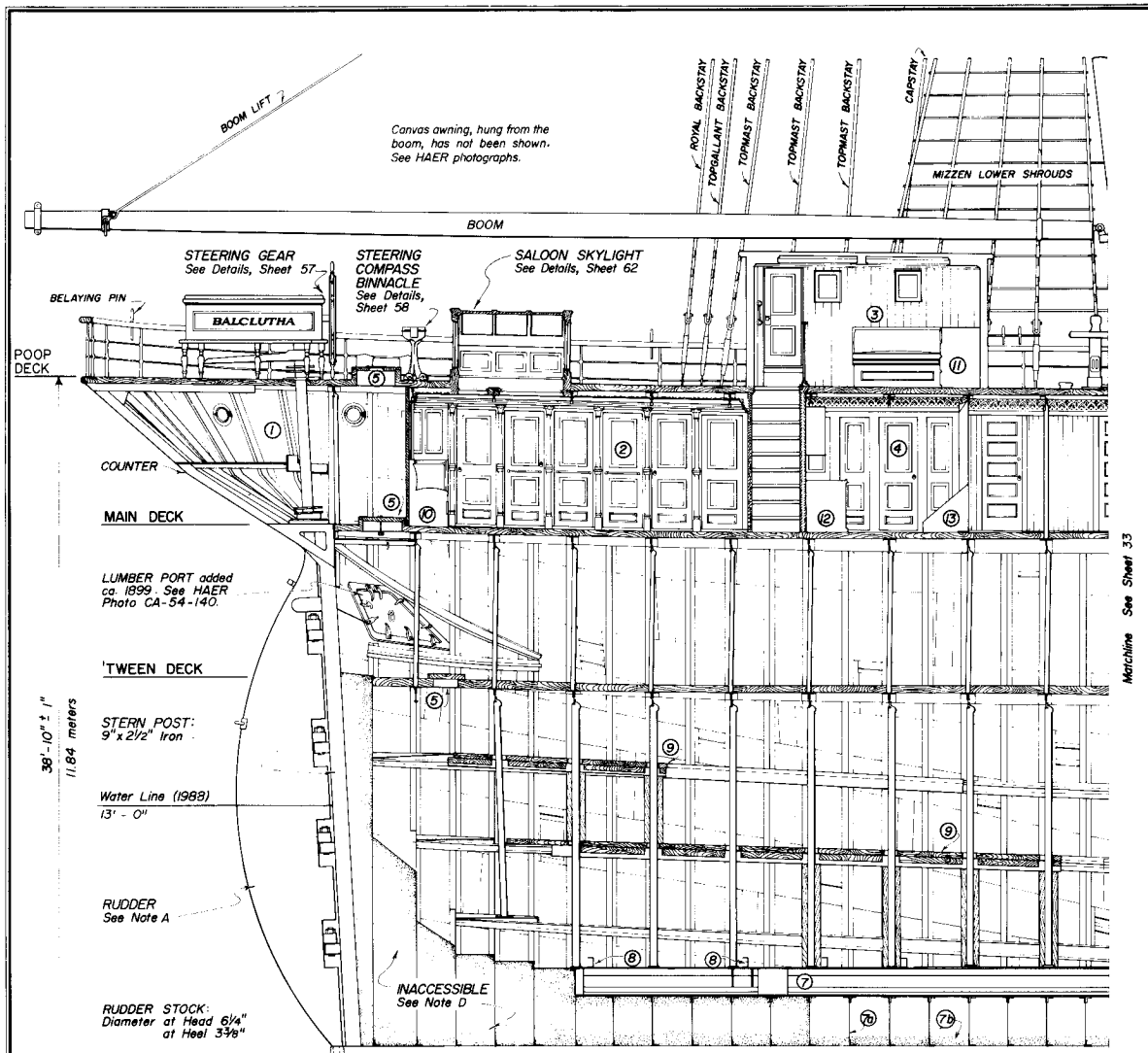

FRAME NUMBER 4 6 8 10 12 14 16 18

PLAN of Heel Gudgeon

NOTES

- A. The rudder was inaccessible for measurement. Information above the waterline was taken from HAER 1987 field photographs. Information below the waterline was derived from photographs taken in 1986 while the ship was in drydock, by Steve Hyman, Rigger Foreman.
- B. Deck heights were located from a datum plane set horizontal to the ship's keel, established with a transit.
- C. Positions of every frame were not measured. Frames were assumed to be 2'-0" centers as per Lloyd's Register of Shipping Survey dated January, 1887. Selected frames were checked to verify positioning at 2'-0" multiples. (See sheet 49 for framing details.)

- D. Much of the lower stern area is filled with cement and was inaccessible for measurement. Structure in this area is assumed. Stern post dimensions are taken from Lloyd's Survey.
- E. Lower plating strokes are coated with approximately 3" to 6" of cement to prevent their oxidation. Depths of the floors, lower angles, and keel were taken from the original midship section.
- F. See Midship Section, sheet 38 for scantlings.
- G. Margin of error, fore and aft, $\pm 1/4$ "; margin of error, keel to deck, $\pm 1/2$ ".

KEY

- 1. STORE ROOM
- 2. SALOON
- 3. CHART HOUSE
- 4. PANTRY
- 5. HATCH
- 6. KEEL: 9 1/2" x 2 1/2" Iron
- 7. KEELSON, see details, Sheet 51.
- 7a. FLOOR
- 7b. CONCRETE, applied as a preservative.
- 8. CHANNEL, welded to hull as strengthener ca. 1960.
- 9. WOODEN SHELVING added ca. 1971 for sail storage (temporary).
- 10. SETTEE
- 11. CHEST OF DRAWERS
- 12. CABINET
- 13. BULKHEAD STIFFENER

INBOARD PROFILE

SECTION 1 of 5



Scale: 3/8" = 1'-0"

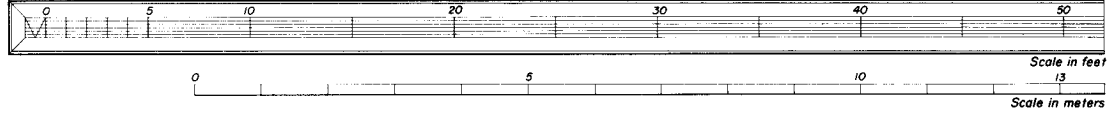

DELIMITED BY Deborah J. Cooper, Robbyn L. Jackson, Richard K. Anderson, Jr. 1987, 1988.

SHIP "BALCLUTHA" RECORDING PROJECT HISTORIC AMERICAN ENGINEERING RECORD UNITED STATES DEPARTMENT OF THE INTERIOR	SAN FRANCISCO	SHIP "BALCLUTHA" (1886) SAN FRANCISCO MARITIME NATIONAL HISTORICAL PARK SAN FRANCISCO COUNTY	CALIFORNIA	SHEET 32 of 69	HISTORIC AMERICAN ENGINEERING RECORD CA - 54
--	---------------	--	------------	----------------	--

IF REPRODUCED, PLEASE CREDIT: HISTORIC AMERICAN ENGINEERING RECORD, NATIONAL PARK SERVICE, NAME OF DELINEATOR, DATE OF THE DRAWING

Fig. 4.7.13

INBOARD PROFILE and PLAN

Fig. 4.7.14

Two Sail Bateau (Skipjack) *E.C. COLLIER*

Layout

Conceptually, the layout is practical and interesting with the graphic scale located between the profile and plan. However, the top of the page seems cramped, while empty space lies below the deck plan. The scale should have been redrawn lower down or placed at the sheet bottom.

Delineation

Good use of line weights. Note heavier line weight along lower edges of profiles.

Hand lettering is neat, and labels do not obscure linework.

Arrows indicate location of labeled features.

Documentation

Notes describe conditions under which the vessel was recorded and verify that in fact, deckhouses are not "square" in plan.

Most principal parts and materials are identified. Notes indicate where to look for more detailed information.

Overall length is given. but not extreme breadth.

Main deck planking was omitted for clarity, but a note describes its construction and indicates where to find more information.

The centerboard lift chain or rod is not shown or noted in this drawing. The user doesn't know if it was omitted on purpose, or was missing at time of documentation.

The figurehead, and eagle, is not mentioned.

DECK BEAM PLAN

Fig. 4.7.15

Schooner *NEWARK*

Delineation

Use of a light line weight is offset by extensive wood graining of structure. However, the overall impression is one of great delicacy.

Wood graining technique used in this drawing is less obtrusive and distracting than the herringbone pattern used on previous examples, but it takes a considerable amount of time to execute.

Documentation

The user is not verbally informed about what is or isn't being shown in the drawing. The presumption is that all parts were measured and located correctly, but the user has no way of verifying this. He does not know which if any parts of the drawing are inferred from other evidence, based on other records, or simply inserted because the delineator feels they must be there.

Although the wood graining is finely executed in this drawing, there is an element in it which is more than simply pictorial. The lodging knees show a curved grain typical of grown knees, i.e., knees cut from tree roots or other parts of trees whose curved grain was ideal for the strongest knees.

One overall dimension is given, but its witness lines did not reproduce, so it cannot be used to scale the drawing. The graphic scale is too small for accurate scaling or checking for distortion in reductions and reproductions.

This drawing is ideal for labeling parts, giving scantlings, and making material notes, but no use was made of the opportunity.

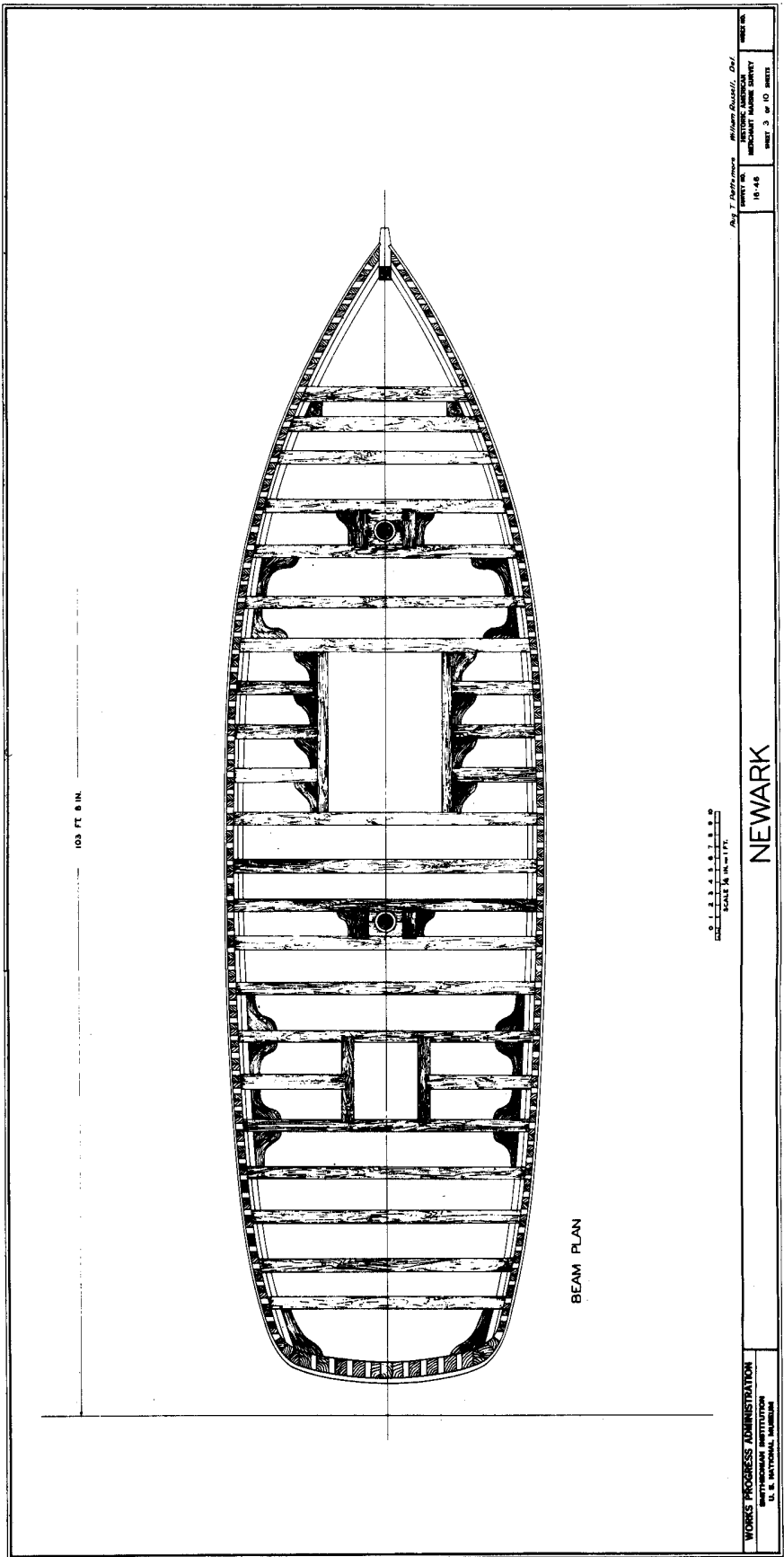

Fig. 4.7.15

DECK PLAN

Figs. 4.7.16 and 4.7.17

Pilot Schooner *ALABAMA*

Layout

Two sheets were used to present the vessel at a reasonable scale and leave space for documentary notes. The sheets may be easily spliced together with little loss, repetition, or rearrangement of information.

Symmetry is used to show a half-deck plan and a half construction (or beam) plan.

A number key system is used in conjunction with labels to keep labels to a minimum in the area of linework.

Delineation

Drawing reads due to use of a variety of line weights and shadowed lines.

Wood graining of sectioned frames and rail stanchions is avoided by using a simple graphic code to distinguish the frames from the stanchions.

Sizes and weights of lettering permit easy reading. View titles are easy to find, notes and scantlings are organized into columns. Labels are almost never made over linework, and arrows are used to make positive identification of labeled features.

A special template drilled with a series of small holes corresponding to the plank edges was pulled along a spline to draw the sprung deck.

Documentation

This view shows a careful attempt to separate existing and historical conditions, accessible from inaccessible features, and information derived first-hand by the field team from that obtained from other sources. Notes point out modification to transom and areas where locations of frames were inferred, not field checked.

Parts are copiously labeled, and the long graphic scale permits its use for scaling parts of the drawing and making accurate reproductions.

No indication is made of field or drafting tolerances, or where they may be found for this drawing set.

- 1. Original Transom Framing (See note C)
- 2. Cove L Bitt
- 3. Lodging Knee
- 4. Mast Partners
- 5. Stern Post
- 6. Stringer
- 7. Steering Gear Box
- 8. Engine Control Panel
- 9. Aft Companionway
- 10. Stove Chimney
- 11. Pilot's Cabin Skylight
- 12. King Plank
- 13. Engine Room Skylight
- 14. Engine Exhaust
- 15. Taffrail Cleat
- 16. Transom Kerklebar

- ☒ FRAME (SEE NOTE A)
- ☐ RAIL STANCHION (SEE NOTE B)

CONSTRUCTION PLAN

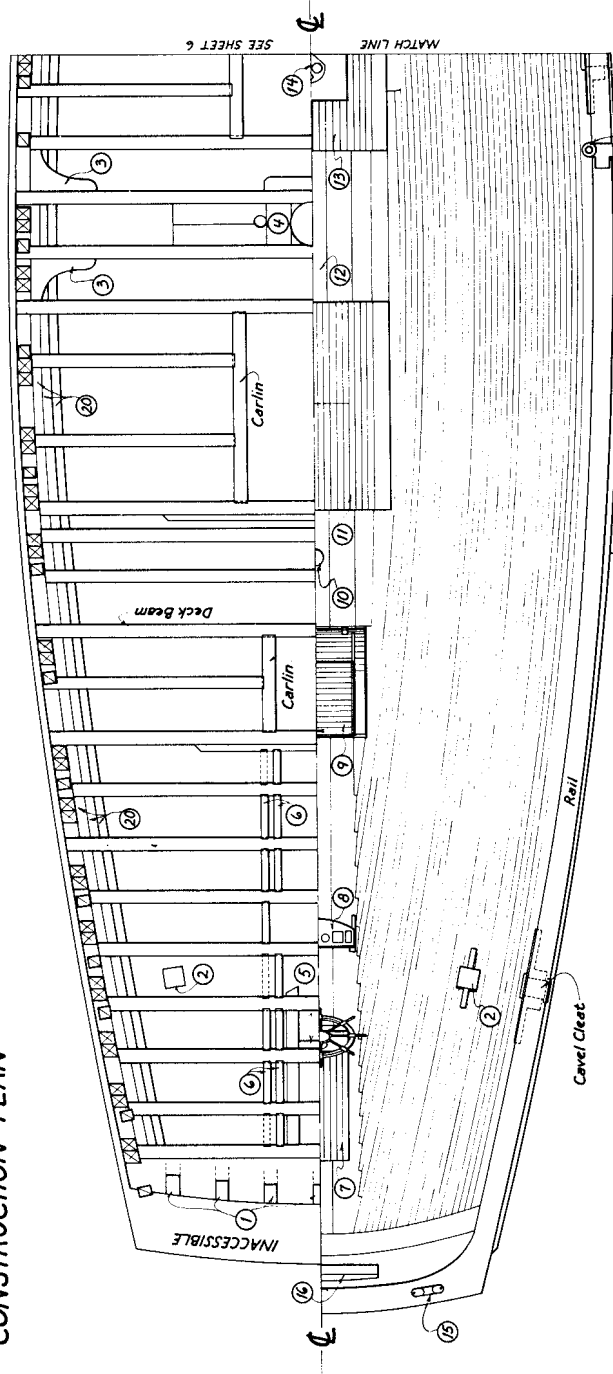

DECK PLAN

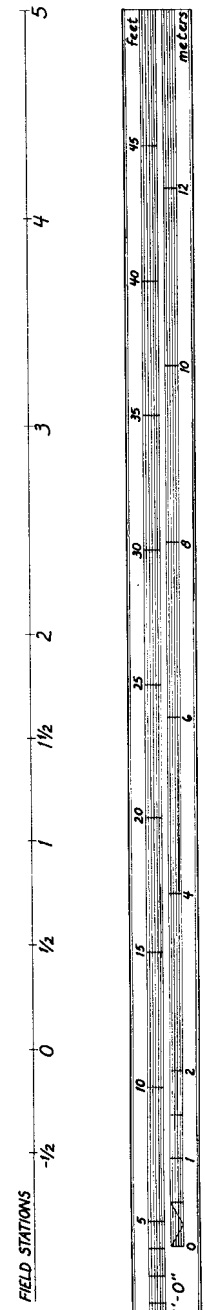

NOTES

- A. The locations of the frames were estimated by eye from their positions between the deck beams. (Accuracy $\pm 1/2"$)
- B. The positions of the rail stanchions on the star-board side differ from those on the port side by $\pm 1/2"$ (fore and aft).
- C. ALABAMA's structure was inaccessible aft of the sternpost. The locations of the ends of the clamps and shelves were not determined, but the drawings reflect the assumption that they are just forward of the original transom.
- D. Approximately 3 feet was added to the transom (date unknown) while the vessel served in Mobile, Alabama. The interior construction of this addition was inaccessible for measurement.
- E. The location of frames aft of Station $1/2$ were not determined in the field.

(Continued on Sheet 6)

Fig. 4.7.16

DECK PLAN

Fig. 4.7.17

Pilot Schooner *ALABAMA*

(see previous comments)

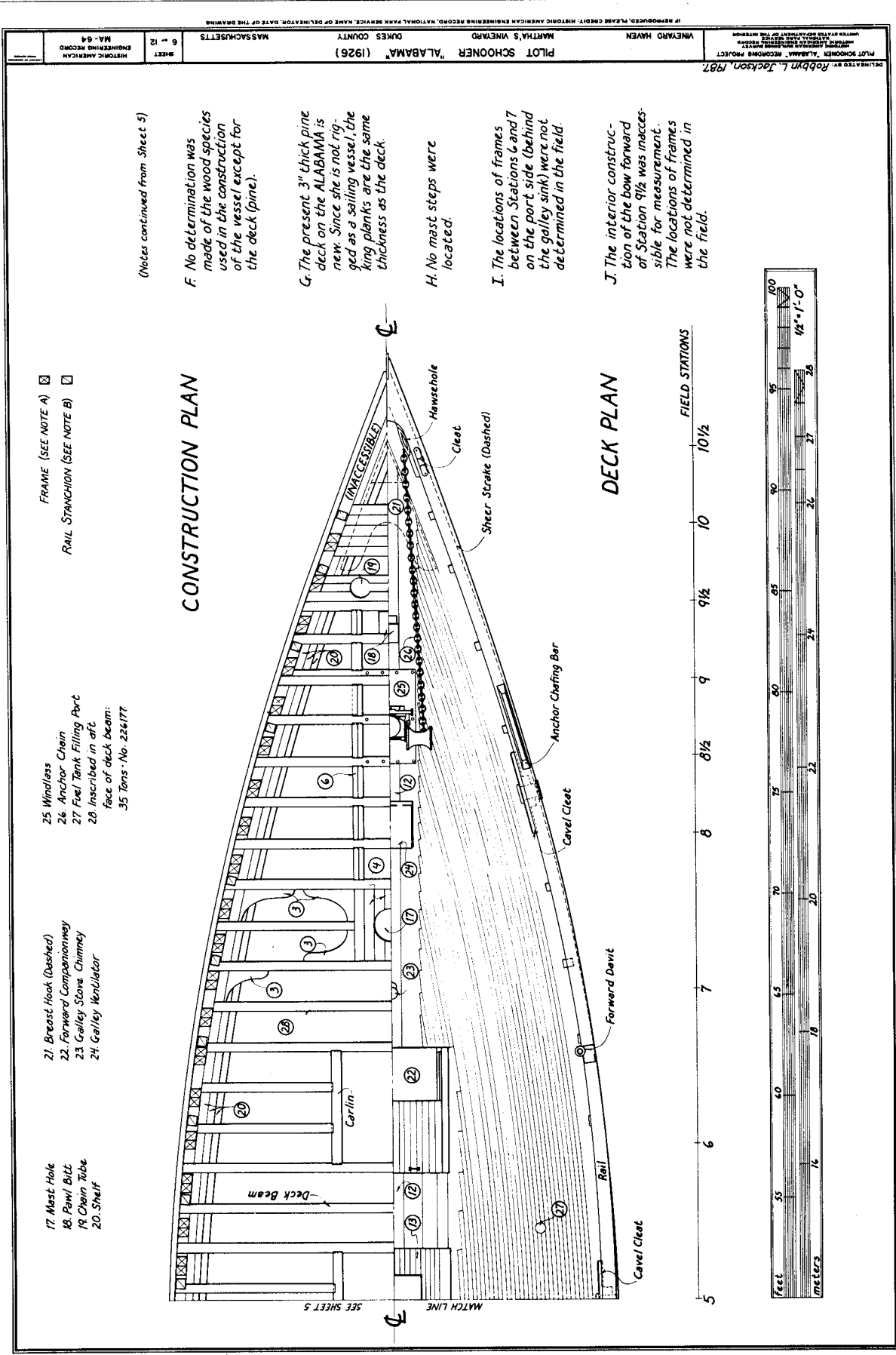

Fig. 4.7.17

SECTIONS

Fig. 4.7.18

Motor Vessel *ROLFE*

Delineation

Very cleanly and precisely delineated, but a trifle light. Only sectioned members are rendered, and the rendering job is just right, not so overdone that joints and details are obscured.

Documentation

This section is commendable because it shows the drifts that hold the vessel together, but where did the delineator get his information? Is it accurate or does it show just what should be there?

Scantlings should have been given, either by labeling and sizing individual parts, or by making up a table.

The joint symbols along the buttock joints should be defined, lest it be confused for a fastener of some kind.

Fig. 4.7.19

Auxiliary Schooner *KATHERINE*

Delineation

Delineation is excellent for a steel vessel, where structural members have much smaller sections than those for wooden vessels. Note that sectioned members are simply blackened in, not hatched.

Rivets are omitted for clarity.

Documentation

Scantlings should have been given, either by labeling and sizing individual parts, or by making up a table.

Rivets are omitted for clarity, but this is not stated. Could someone confuse it, however briefly, for welded construction? Where should the user go in the drawing set if he wants details of rivet patterns?

Rotated sections might have been shown (as well as labeled and sized) for built-up frames, deck beams and stanchions.

Dimensional and structural verification needed (longer graphic scale, principal dimensions, condition of vessel, sources of information, etc.).

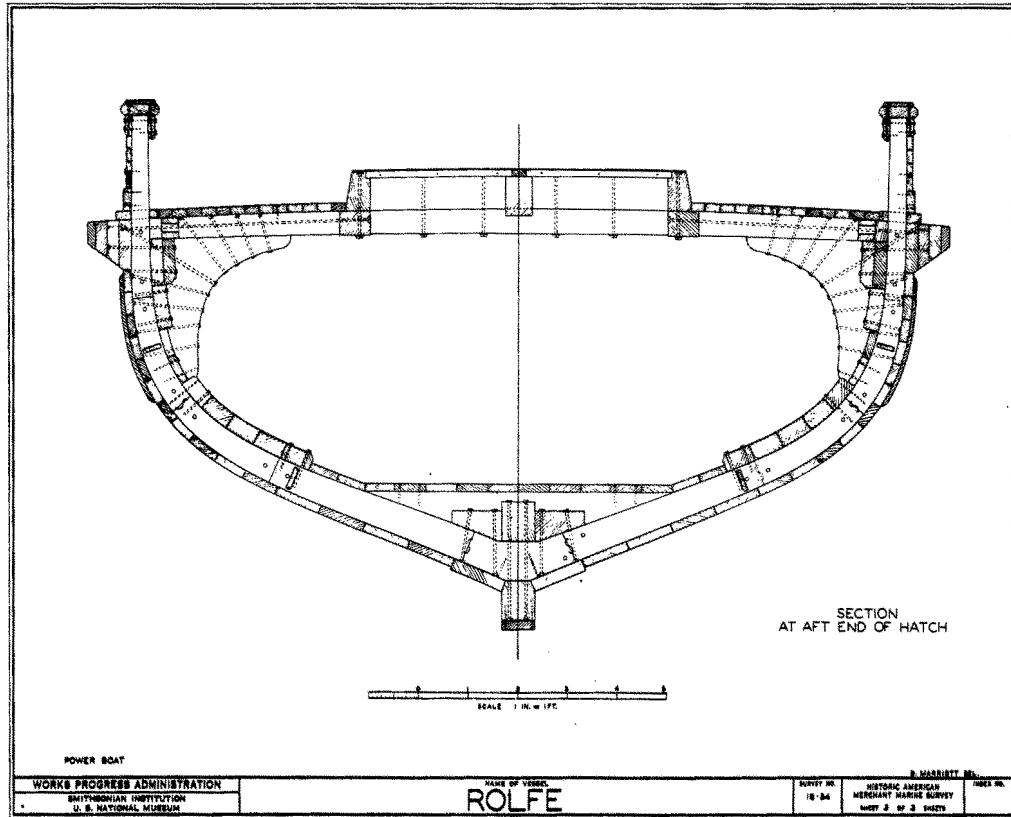

Fig. 4.7.18

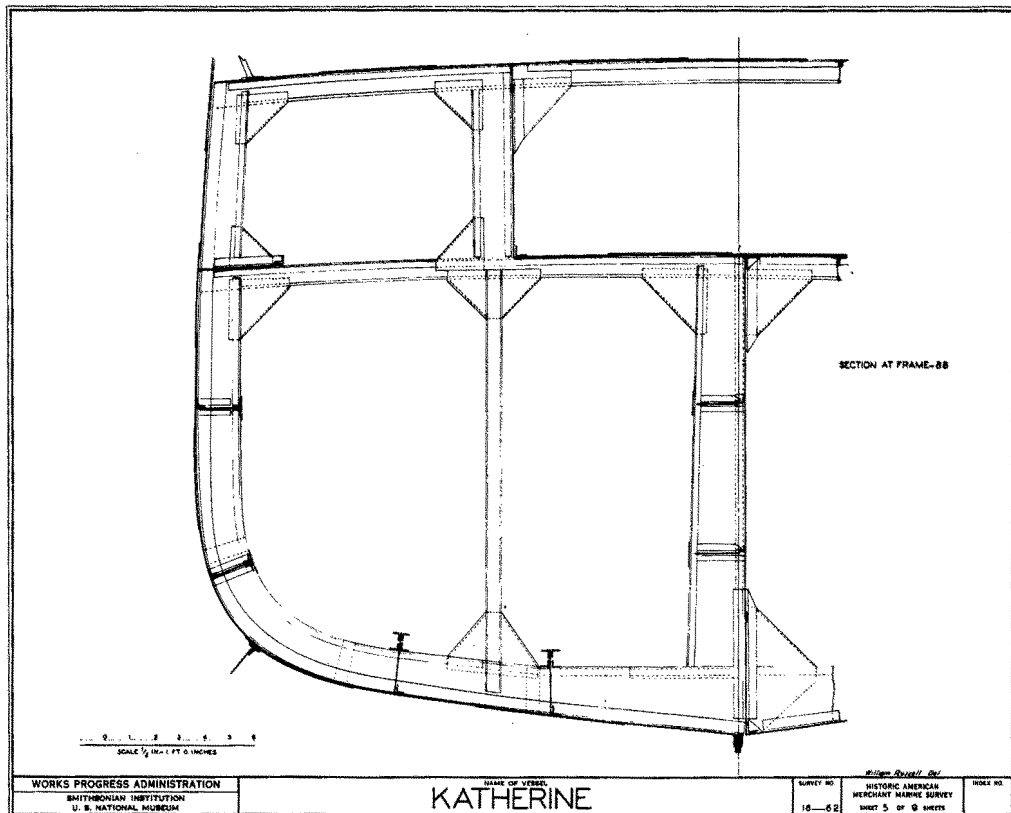

Fig. 4.7.19

MIDSHIP SECTION

Fig. 4.7.20

Ship *BALCLUTHA*

Layout

This sheet tries to do too much. Because there was not enough room for all of the notes to appear at the side of the drawing, they have been spread out over the sheet in a way that detracts from the overall appearance and legibility. Perhaps this information should have been spread out over two sheets, or a smaller scale used for the midship section

The positioning of the midship section, labels and graphic scale is good.

Delineation

Good use of line weights and pochés.

The large lettering used for the view title clearly identifies this drawing.

There is some confusion with dashed lines: sometimes they are used to denote a hidden feature, sometimes to denote modern additions.

The labels do not obscure the linework and arrows positively identify labeled features.

Documentation

Notes indicate that this drawing was based on an original drawing, and the location of the original is given.

Notes clearly identify features that aren't original.

Where possible, labels with scantlings are located near the feature, although those at the top of the sheet seem a little out of place.

The maximum beam is given, but no dimensions are supplied for deck heights and depth of hold.

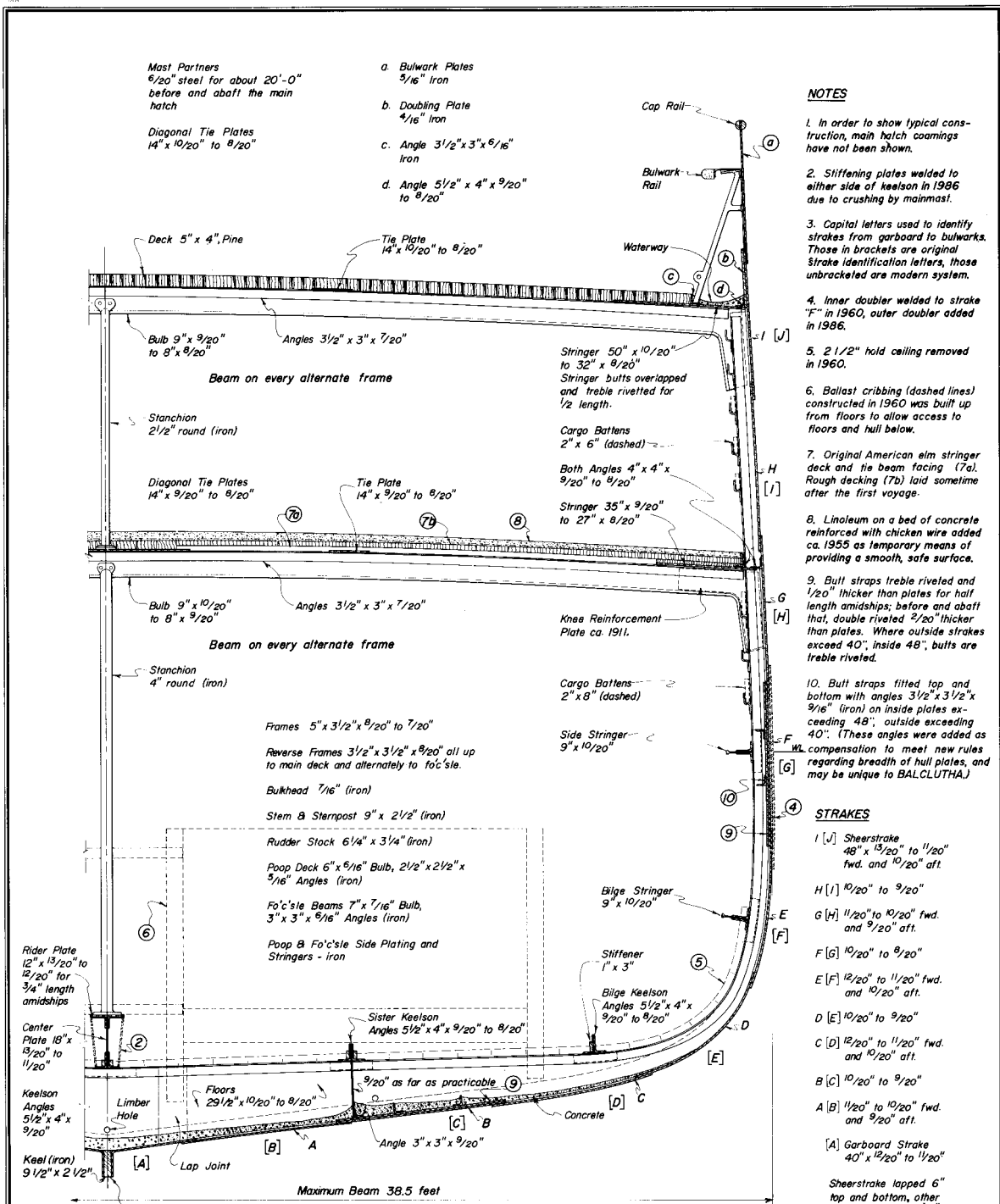

- NOTES**
- In order to show typical construction, main hatch coamings have not been shown.
 - Stiffening plates welded to either side of keelson in 1986 due to crushing by mainmast.
 - Capital letters used to identify strokes from garboard to bulwarks. Those in brackets are original stroke identification letters, those unbracketed are modern system.
 - Inner doubler welded to stroke "F" in 1960, outer doubler added in 1986.
 - 2 1/2" hold ceiling removed in 1960.
 - Ballast cribbing (dashed lines) constructed in 1960 was built up from floors to allow access to floors and hull below.
 - Original American elm stringer deck and tie beam facing (7a). Rough decking (7b) laid sometime after the first voyage.
 - Linoleum on a bed of concrete reinforced with chicken wire added ca. 1955 as temporary means of providing a smooth, safe surface.
 - Bull straps treble riveted and 1/20" thicker than plates for half length amidships; before and abaft that, double riveted 2/20" thicker than plates. Where outside strokes exceed 40', inside 48', butts are treble riveted.
 - Bull straps fitted top and bottom with angles 3 1/2" x 3 1/2" x 9/16" (iron) on inside plates exceeding 48', outside exceeding 40'. (These angles were added as compensation to meet new rules regarding breadth of hull plates, and may be unique to BALCLUTHA.)

- STRAKES**
- I [J] Sheerstrake
48" x 13/20" to 11/20"
fwd. and 10/20" aft
 - H [I] 10/20" to 9/20"
 - G [H] 11/20" to 10/20" fwd.
and 9/20" aft.
 - F [G] 10/20" to 8/20"
 - E [F] 12/20" to 11/20" fwd.
and 10/20" aft.
 - D [E] 10/20" to 9/20"
 - C [D] 12/20" to 11/20" fwd.
and 10/20" aft.
 - B [C] 10/20" to 9/20"
 - A [B] 11/20" to 10/20" fwd.
and 9/20" aft.
 - [A] Garboard Strake
40" x 12/20" to 11/20"
- Sheerstrake lapped 6"
top and bottom, other
Strakes lapped 5 1/4".

MIDSHIP SECTION

Scantlings taken from original Midship Section dated May 19, 1886
A copy can be found at the San Francisco Maritime National Historical Park.

See Sheet 51 for
Keelson, Sister Keelson,
Side Stringer and Butt
Strap Details

Scantlings were field verified
where accessible in 1987-1988.
Metal is steel unless noted
otherwise.

Scale: 3/4" = 1' - 0"

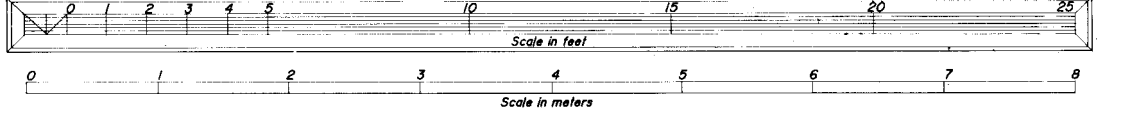

DELINEATED BY Robbyn L. Jackson, 1989		SHIP "BALCLUTHA" RECORDING PROJECT		SHIP "BALCLUTHA" (1886)		SHEET 38 of 69	
HISTORIC AMERICAN ENGINEERING RECORD		NATIONAL PARK SERVICE		SAN FRANCISCO MARITIME NATIONAL HISTORICAL PARK		HISTORIC AMERICAN ENGINEERING RECORD	
UNITED STATES DEPARTMENT OF THE INTERIOR		SAN FRANCISCO		SAN FRANCISCO COUNTY		CALIFORNIA	
IF REPRODUCED, PLEASE CREDIT: HISTORIC AMERICAN ENGINEERING RECORD, NATIONAL PARK SERVICE, NAME OF DELINEATOR, DATE OF THE DRAWING							

Fig. 4.7.20

SAIL PLANS

Fig. 4.7.21

Sharpie (unnamed)

This sort of documentation is unlikely to come up very often, since sails are pretty ephemeral when compared to hulls and machinery. However, if documentation of a vessel's sails is important to do, this drawing has some good and bad points:

Documentation

Dimensions of all sides of each sail are given, including a diagonal measurement.

Some construction features are noted, such as the reef.

Most construction details of these particular sails are omitted without explanation. Materials are not given either. It would be wise to cite some reference where similar details could be investigated, if a user wished to do so.

Spar sizes and some line diameters (but not materials) are given. Note that no graphic scale is given.

Plan No. HIC-128, 44'-6" Sharpie Schooner (sheet 4), Howard I. Chapelle
 Collection of yachts and small craft. Delineated by Howard I. Chapelle.
 Reproduced courtesy of the Smithsonian Institution.

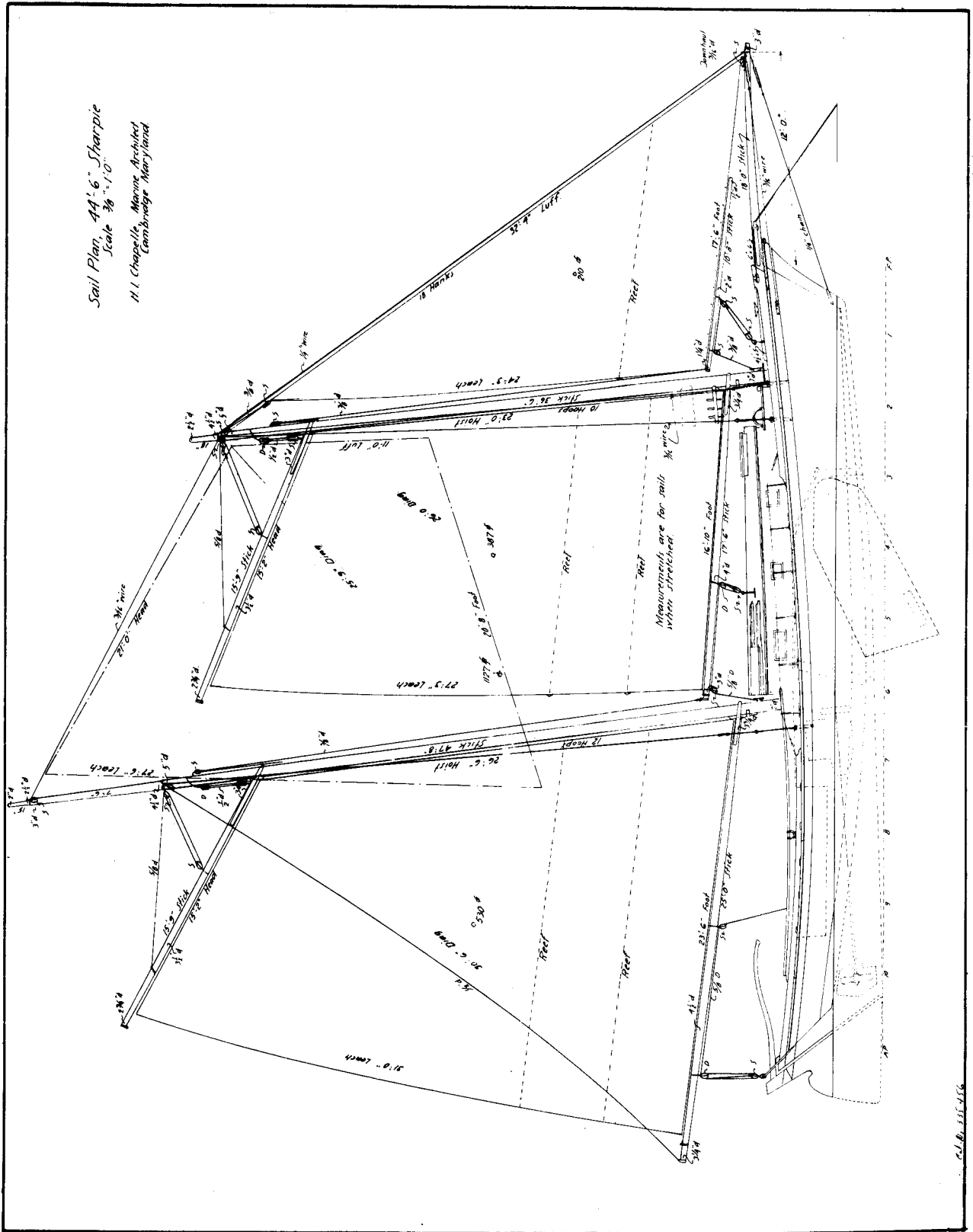

Fig. 4.7.21

SAIL PLANS

Fig. 4.7.22

Schooner *EFFIE A. CHASE*

Documentation

There is not much this plan shows that couldn't be shown on an outboard profile. Notes on sail area take up no great space.

No dimensions are given verbally, and graphic scale is too small to use reliably on size features shown. Lack of dimensions should have been explained.

Source for the drawing is cited, but a more complete citation would have been useful (did the "old book" have a date or not?). The information presented on this sheet could have been more economically preserved by photocopying the page in the old book, unless the notations were difficult to read or photograph.

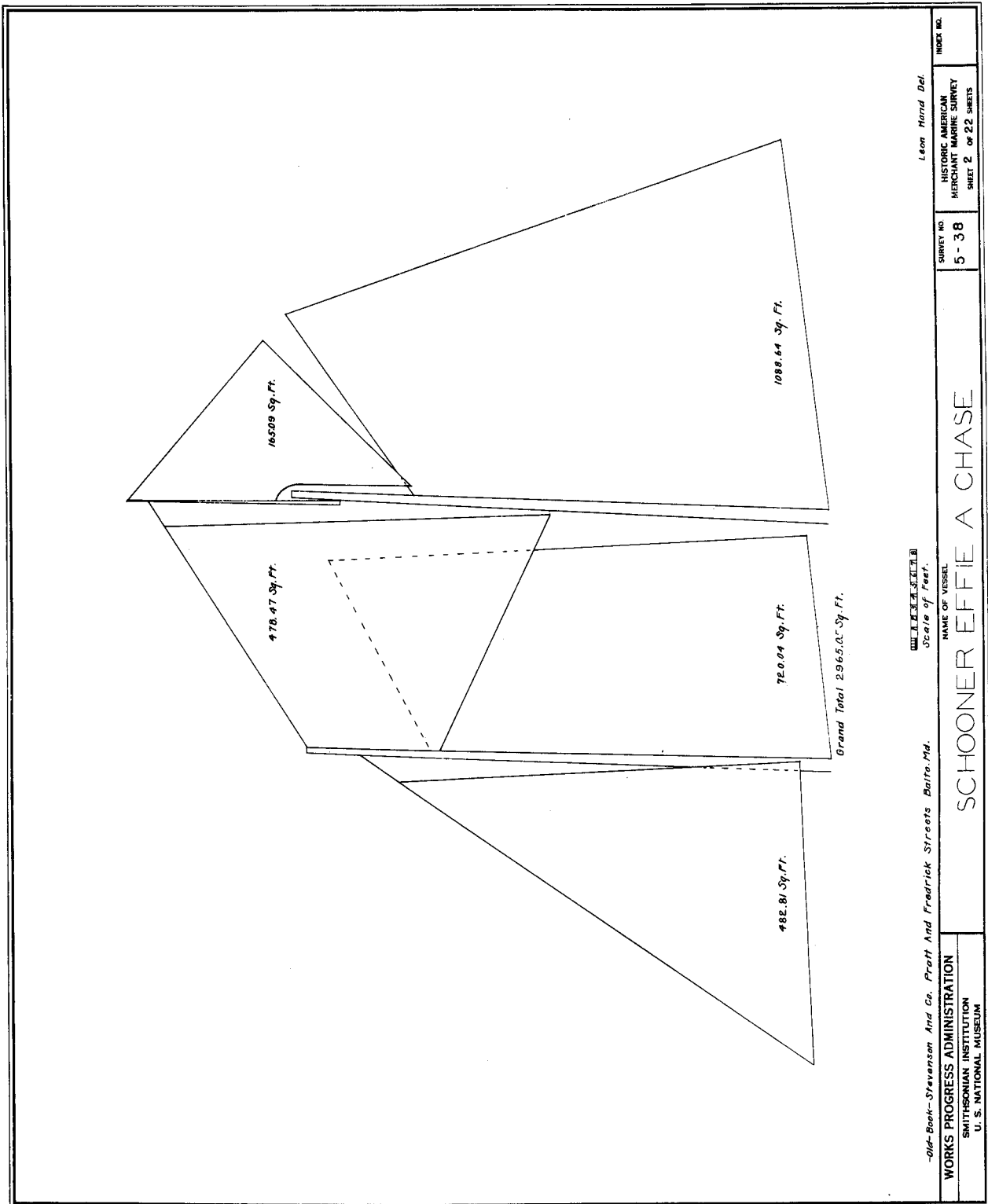

Fig. 4.7.22

SAIL PLANS

Fig. 4.7.23

Skipjack *KATHRYN*

In addition to schematic or technical sail plans, measured drawings can illustrate the actual sail construction and materials.

Layout

The sails are arranged similar to its location on the vessel with the foresail in the traditional forward side (when looking at the starboard profile) and the main sail aft of that.

Details are located around the central image.

Delineation

Line weights show variation from outlines to stitching patterns, with stippling to add texture to the sail cloth wrinkles.

Documentation

The sail was measured while laid out flat on a lawn and does not represent the actual sail cloth shape, which would have added material to create the “belly” of the sail within the triangle.

Written dimensions are given in the text, but dimension lines would help clarify the measurement locations.

Detail views are keyed to the main view for clarity of location.

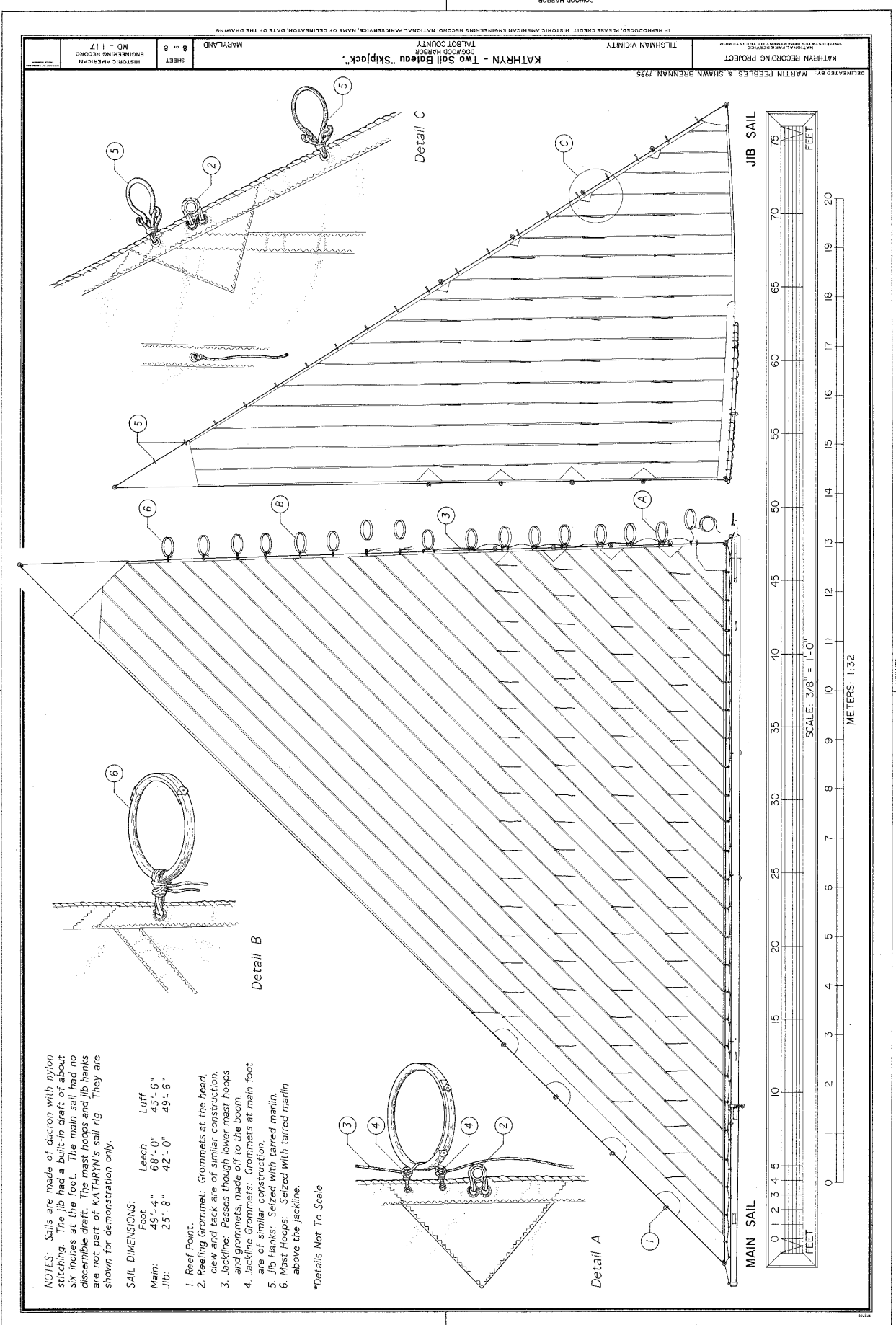

Fig. 4.7.23

SPAR AND RIGGING TABLE

Fig. 4.7.24

Bark *NEWSBOY*

When significance or recording project purposes dictate the recording of rigging, the tabulation of spar and line dimensions can be a very efficient form of documentation. The information presented here could also be labeled onto a profile view of the vessel, but a table makes for quicker comparisons. If project documentation is to be used for maintenance of a vessel, tabulated data such as this would be very useful for planning work, ordering materials, and other maintenance tasks.

SPAR LIST										WIRE RIGGING		CHAIN RIGGING	
NAME	MOUSING	DECK TO	HEAD	EXTREME	DIA AT	DIA AT	DIA AT	DIA AT	DIA AT				
		HEAD		LENGTH	HEEL	DECK	HEAD	HEAD	CAP				
FORE MAST	13'-0"	22'-3"	13'-6"	68'-9"	24"	27"	26" x 10"	16"		MAIN SKYSAIL STAY	1 1/2"	FORE & MAIN TOPSAIL HALLIARDS	2 1/2"
MAIN MAST	11'-6"	46'-0"	13'-6"	71'-0"	24"	27"	24" x 10"	16"		FORE & MAIN ROYAL STAYS	2"	" " " TOPSAIL HALLIARDS	2"
MIZZEN MAST	12'-6"	47'-0"	11'-0"	70'-6"	20"	23"	19" x 14"	12 1/2"		" " " TOPGALLANT STAYS	2 1/2"	" " " TOPSAIL SHEETS	2"
										OUTER & INNER STAYS	3"	" " " TOPGALLANT SHEETS	2"
NAME										FORE & MAIN TOPMAST STAYS	3 1/2"	" " " ROYAL SHEETS	2"
BOWSPRIT	17'-6"	20'-6"	38'-0"	24"	27"	20 1/2"				" " " STAYS & SHROUDS	4"	" " " TOPGALLANT HALLIARDS	2"
										" " " CAPS BACKSTAYS	4"	" " " " - RUNNER	2"
NAME										" " " TOPMAST BACKSTAYS	3 1/2"	" " " ROYAL HALLIARD	2"
JIBBOOM	20'-6"	13'-0"	17'-0"	3'-9"	11"	17"	10 1/2" x 10 1/2" x 1 1/2"	4 1/2"		" " " TOPGALLANT "	2 1/2"	" " " YARD SLINGS	1 1/2"
NAME										" " " ROYAL	2 1/2"	" " " MAIN SKYSAIL HALLIARDS	2 1/2"
FORE & MAIN TOPMASTS	1'-4" 3/4"	8'-0"	44'-0"	16 1/2"	16 1/2" 12"	11"				" " " TOPMAST SHROUDS	2 1/2"	" " " SHEETS	2"
NAME										" " " TOPGALLANT "	2"	" " " SHANK POINTERS	2"
FORE ROYAL	12'-0"	14'-0"	11'-0"	4'-6"	42'-9"	11 1/2" 10"	14 1/2" 10" 8 1/2" 7"	3"		MIZZEN TOP GALLANT STAY	2"	" " " RING STOPPERS	2"
MAIN ROYAL	12'-0"	14'-0"	11'-0"	4'-6"	42'-9"	11 1/2" 10"	14 1/2" 10" 8 1/2" 7"	3"		MIZZEN TOPMAST STAY	2 1/2"	" " " BOWSPRIT SHROUDS (INNER TRIM)	2"
MIZZEN ROYAL	12'-0"	14'-0"	11'-0"	4'-6"	42'-9"	11 1/2" 10"	14 1/2" 10" 8 1/2" 7"	3"		" " " STAY	3 1/2"	" " " MARTINGALE STAYS & BACKROPES	1 1/2"
MIZZEN TOPMAST AND TOPGALLANT MAINT	17'-11"			4'-6"	58'-1"	10 1/2" 10" 7 1/2" 6"				" " " SHROUDS	3 1/2"	" " " " (OUTER ONE)	2"
NAME										" " " TOPMAST BACKSTAY	2 1/2"	" " " BOB STAYS	1"
FORE & MAIN LOWER YARDS				73'-0"	2'-6"	17"	5 1/2" x 8"	4"		" " " TOPGALLANT "	2"	" " " TOPMAST SHROUD	2"
MAIN TOPSAIL YARDS				63'-3"	0'-6"	14 1/2"	6" x 7"	5 1/2"		BRACE BACKSTAY	2 1/2"	" " " BRACE BACKSTAY	2 1/2"
UPPER YARDS				60'-0"	2'-6"	13"	7 1/2" x 6 1/2"	3 1/2"		INNER JIBBOOM GUNS	3 1/2"	" " " INNER JIBBOOM GUNS	3 1/2"
TOPGALLANT YARDS				47'-0"	2'-0"	10 1/2"	6" x 5"	2 1/2"		OUTER	3"	" " " OUTER	3"
ROYAL YARDS				37'-0"	1'-6"	8 1/2"	5 1/2" x 4"	2 1/2"		FLYING	2 1/2"	" " " FLYING	2 1/2"
SKYSAIL YARDS				27'-0"	1'-0"	6 1/2"	4" x 3 1/2"	2"		FORE & MAIN ROYAL LIFTS	1 1/2"	" " " FORE & MAIN ROYAL LIFTS	1 1/2"
NAME										" " " TOPGALLANT LIFTS	2"	" " " TOPGALLANT LIFTS	2"
MIZZEN GAFF				26'-0"	3'-8"	29'-8"	8" x 8" x 6 1/2" x 5 1/2"	3"		" " " TOP-MAST	2 1/2"	" " " TOP-MAST	2 1/2"
NAME													
MIZZEN BOOM				40'-3"	3'-3"	43'-6"	8 1/2" x 10 1/2" x 8 1/2" x 6 1/2"	4"					

NOTE: CORRECT FROM SOL PLAN DATED FEB. 24, 1950

WORKS PROGRESS ADMINISTRATION
 SMITHSONIAN INSTITUTION
 U. S. NATIONAL MUSEUM

NAME OF VESSEL
 BATTLE

SURVEY NO.
 162-26

HISTORIC AMERICAN
 MERCHANT MARINE SURVEY
 SHEET 4 OF 4 SHEETS

1-11-50

Fig. 4.7.24

STANDING AND RUNNING RIGGING TABLES

Fig. 4.7.25

Barkentine *KOKO HEAD*

This table is far more detailed and complete than Fig. 4.7.36 so far as rigging goes. It gives no spar dimensions. Such a table would be a boon for maintenance of a vessel, and useful also to ship modellers, and for studies of rigging. Some of the abbreviations used in the table need explanation (e.g., "pat" and "com" under "type"). Depending on the significance of the vessel being recorded, the nature of her rig, and what is to be done with the documentation (project agenda), such a table could be a very low or a very high priority. Legibility is paramount in a table with this much information.

RUNNING GEAR -CONTINUED-

BLOCK AND SHEAVE LIST	NO. WANTED	SHEAVE DIA.	SHEAVE WIDTH	TYPE	DESCRIPTION	WIRE		ROPE CHAIN	
						LN DIA	LN DIA	LN DIA	LN DIA
SPANNER HALVARD	1	10 1/4	15	TRIPLE PAT	WITH SHACKLE TO WYTHE BAND	10 1/4	15	335	12
• PURCHASE	1	10 1/4	15	DOUBLE	FOR ROPE STRAP	120	38	34	
• SHEET	1	19 1/2	7 1/4	DOUBLE COM	WITH SHACKLE AND BECKET, WIDE MORTICE	300	1/2		
• BORN TACKLE	1	12	12	SINGLE	OUTSIDE IRON STRAP SHACKLE EGG SHELL	175	1/4		
• REEF	1	4 3/4	6	SINGLE	LOOSE SWIVEL HOOK AND BECKET	120	7/8		
• TOPPING LIFT	1	5 1/2	3 1/2	DOUBLE	FOR ROPE STRAP	165	7/8		
• MAIN LEAD-THROAT HALVARD	2	10 1/4	15	TRIPLE	WITH SISTER HOOKS AND BECKET	800	1/2		
• PEAR	2	10 1/4	15	DOUBLE	LOOSE SWIVEL HOOK FOR GAFF	1600	1/4		
• PURCHASE	2	10 1/4	15	DOUBLE	SOLID EYE FOR GAFFS	1600	1/4		
• PURCHASE	2	10 1/4	15	DOUBLE	SHACKLES FOR WYTHE BANDS	500			
• TOPPING LIFTS	2	4 3/4	6	SINGLE	FOR ROPE STRAP	340	10	5 1/2	15
• SHEETS	2	10 1/4	15	DOUBLE	WITH SISTER HOOKS	400	1/2		
• BEAM TACKLES	2	10 1/4	15	DOUBLE COM	SHACKLES AND BECKET, WIDE MORTICE	190	1/2		
• REEF TACKLE	2	4 3/4	6	SINGLE PAT	WITH OUTSIDE IRON STRAP SHACKLE EGG SHELL	120	1/4		
• GAFF TOPSAIL HALL	2	10 1/4	15	DOUBLE	LOOSE SWIVEL HOOKS	320	7/8		
• SHEETS	2	10 1/4	15	DOUBLE	AND	300	1/4		
• SHEETS	2	10 1/4	15	DOUBLE	SISTER HOOKS	260	7/8		
• SHEETS	2	10 1/4	15	DOUBLE	COM SPECIAL FOR GAFF END, SEE DETAIL	120	7/8		
• SHEETS	2	10 1/4	15	DOUBLE	PAT WITH LASHING EYE	950	3/8		
• PURCHASE	2	10 1/4	15	DOUBLE	MAST SHEAVE FOR SKY-S-CHAIN TIE	454	3/4	30	3/8
• PURCHASE	2	10 1/4	15	DOUBLE	SHACKLE BLOCK	280	7/8		
• PURCHASE	2	10 1/4	15	DOUBLE	WITH SISTER HOOKS AND BECKET	120	7/8		
• PURCHASE	2	10 1/4	15	DOUBLE	ONLY	340	7/8		
• PURCHASE	2	10 1/4	15	DOUBLE	ROYAL YARD ARM SHEAVES FOR SHEET CHAIN	500	3/8	30	3/8
• PURCHASE	2	10 1/4	15	DOUBLE	MAST SHEAVE FOR CHAIN TIE	448	3/4	24	3/8
• PURCHASE	2	10 1/4	15	DOUBLE	WITH SISTER HOOKS AND BECKET	448	3/4	24	3/8
• PURCHASE	2	10 1/4	15	DOUBLE	ONLY	150	1/2		
• PURCHASE	2	10 1/4	15	DOUBLE	AND QUARTER BLOCKS	200	7/8		
• PURCHASE	2	10 1/4	15	DOUBLE	FOR TOP GALLANT YARD ARM SHEAVES	200	7/8		
• PURCHASE	2	10 1/4	15	DOUBLE	MAST SHEAVE FOR CHAIN TIE	150	1/2		
• PURCHASE	2	10 1/4	15	DOUBLE	ONLY	104	1/2		
• PURCHASE	2	10 1/4	15	DOUBLE	UPPER TOPSAIL AND QUARTER BLOCKS	48	7/8		
• PURCHASE	2	10 1/4	15	DOUBLE	FOR ROPE STRAP	432	3/4	24	3/4
• PURCHASE	2	10 1/4	15	DOUBLE	PAT WITH SISTER HOOKS	434	3/4	24	3/4
• PURCHASE	2	10 1/4	15	DOUBLE	ROPE STRAPS	420	40	1	38
• PURCHASE	2	10 1/4	15	DOUBLE	AND BECKET	150			
• PURCHASE	2	10 1/4	15	DOUBLE	SISTER HOOKS	150			
• PURCHASE	2	10 1/4	15	DOUBLE	FOR TOPSAIL AND QUARTER BLOCKS	400	3/4		
• PURCHASE	2	10 1/4	15	DOUBLE	ROPE STRAPS	256	3/4		
• PURCHASE	2	10 1/4	15	DOUBLE	SISTER HOOKS	256	3/4		
• PURCHASE	2	10 1/4	15	DOUBLE	AND QUARTER BLOCKS	120	1/2		
• PURCHASE	2	10 1/4	15	DOUBLE	ROPE STRAPS	200	1/2		
• PURCHASE	2	10 1/4	15	DOUBLE	AND QUARTER BLOCKS	248	3/4		
• PURCHASE	2	10 1/4	15	DOUBLE	ROPE STRAPS	256	3/4		
• PURCHASE	2	10 1/4	15	DOUBLE	AND QUARTER BLOCKS	120	1/2		
• PURCHASE	2	10 1/4	15	DOUBLE	ROPE STRAPS	248	3/4		
• PURCHASE	2	10 1/4	15	DOUBLE	AND QUARTER BLOCKS	256	3/4		
• PURCHASE	2	10 1/4	15	DOUBLE	ROPE STRAPS	360	7/8	16	1 1/8

RUNNING GEAR

BLOCK AND SHEAVE LIST	NO. WANTED	SHEAVE DIA.	SHEAVE WIDTH	TYPE	DESCRIPTION	WIRE		ROPE CHAIN	
						LN DIA	LN DIA	LN DIA	LN DIA
SPANNER HALVARD	1	10 1/4	15	TRIPLE PAT	WITH SHACKLE TO WYTHE BAND	10 1/4	15	335	12
• PURCHASE	1	10 1/4	15	DOUBLE	FOR ROPE STRAP	120	38	34	
• SHEET	1	19 1/2	7 1/4	DOUBLE COM	WITH SHACKLE AND BECKET, WIDE MORTICE	300	1/2		
• BORN TACKLE	1	12	12	SINGLE	OUTSIDE IRON STRAP SHACKLE EGG SHELL	175	1/4		
• REEF	1	4 3/4	6	SINGLE	LOOSE SWIVEL HOOK AND BECKET	120	7/8		
• TOPPING LIFT	1	5 1/2	3 1/2	DOUBLE	FOR ROPE STRAP	165	7/8		
• MAIN LEAD-THROAT HALVARD	2	10 1/4	15	TRIPLE	WITH SISTER HOOKS AND BECKET	800	1/2		
• PEAR	2	10 1/4	15	DOUBLE	LOOSE SWIVEL HOOK FOR GAFF	1600	1/4		
• PURCHASE	2	10 1/4	15	DOUBLE	SOLID EYE FOR GAFFS	1600	1/4		
• PURCHASE	2	10 1/4	15	DOUBLE	SHACKLES FOR WYTHE BANDS	500			
• TOPPING LIFTS	2	4 3/4	6	SINGLE	FOR ROPE STRAP	340	10	5 1/2	15
• SHEETS	2	10 1/4	15	DOUBLE	WITH SISTER HOOKS	400	1/2		
• BEAM TACKLES	2	10 1/4	15	DOUBLE COM	SHACKLES AND BECKET, WIDE MORTICE	190	1/2		
• REEF TACKLE	2	4 3/4	6	SINGLE PAT	WITH OUTSIDE IRON STRAP SHACKLE EGG SHELL	120	1/4		
• GAFF TOPSAIL HALL	2	10 1/4	15	DOUBLE	LOOSE SWIVEL HOOKS	320	7/8		
• SHEETS	2	10 1/4	15	DOUBLE	AND	300	1/4		
• SHEETS	2	10 1/4	15	DOUBLE	SISTER HOOKS	260	7/8		
• SHEETS	2	10 1/4	15	DOUBLE	COM SPECIAL FOR GAFF END, SEE DETAIL	120	7/8		
• SHEETS	2	10 1/4	15	DOUBLE	PAT WITH LASHING EYE	950	3/8		
• PURCHASE	2	10 1/4	15	DOUBLE	MAST SHEAVE FOR SKY-S-CHAIN TIE	454	3/4	30	3/8
• PURCHASE	2	10 1/4	15	DOUBLE	SHACKLE BLOCK	280	7/8		
• PURCHASE	2	10 1/4	15	DOUBLE	WITH SISTER HOOKS AND BECKET	120	7/8		
• PURCHASE	2	10 1/4	15	DOUBLE	ONLY	340	7/8		
• PURCHASE	2	10 1/4	15	DOUBLE	ROYAL YARD ARM SHEAVES FOR SHEET CHAIN	500	3/8	30	3/8
• PURCHASE	2	10 1/4	15	DOUBLE	MAST SHEAVE FOR CHAIN TIE	448	3/4	24	3/8
• PURCHASE	2	10 1/4	15	DOUBLE	WITH SISTER HOOKS AND BECKET	448	3/4	24	3/8
• PURCHASE	2	10 1/4	15	DOUBLE	ONLY	150	1/2		
• PURCHASE	2	10 1/4	15	DOUBLE	AND QUARTER BLOCKS	200	7/8		
• PURCHASE	2	10 1/4	15	DOUBLE	FOR TOP GALLANT YARD ARM SHEAVES	200	7/8		
• PURCHASE	2	10 1/4	15	DOUBLE	MAST SHEAVE FOR CHAIN TIE	150	1/2		
• PURCHASE	2	10 1/4	15	DOUBLE	ONLY	104	1/2		
• PURCHASE	2	10 1/4	15	DOUBLE	UPPER TOPSAIL AND QUARTER BLOCKS	48	7/8		
• PURCHASE	2	10 1/4	15	DOUBLE	FOR ROPE STRAP	432	3/4	24	3/4
• PURCHASE	2	10 1/4	15	DOUBLE	PAT WITH SISTER HOOKS	434	3/4	24	3/4
• PURCHASE	2	10 1/4	15	DOUBLE	ROPE STRAPS	420	40	1	38
• PURCHASE	2	10 1/4	15	DOUBLE	AND BECKET	150			
• PURCHASE	2	10 1/4	15	DOUBLE	SISTER HOOKS	150			
• PURCHASE	2	10 1/4	15	DOUBLE	FOR TOPSAIL AND QUARTER BLOCKS	400	3/4		
• PURCHASE	2	10 1/4	15	DOUBLE	ROPE STRAPS	256	3/4		
• PURCHASE	2	10 1/4	15	DOUBLE	SISTER HOOKS	256	3/4		
• PURCHASE	2	10 1/4	15	DOUBLE	AND QUARTER BLOCKS	120	1/2		
• PURCHASE	2	10 1/4	15	DOUBLE	ROPE STRAPS	200	1/2		
• PURCHASE	2	10 1/4	15	DOUBLE	AND QUARTER BLOCKS	248	3/4		
• PURCHASE	2	10 1/4	15	DOUBLE	ROPE STRAPS	256	3/4		
• PURCHASE	2	10 1/4	15	DOUBLE	AND QUARTER BLOCKS	120	1/2		
• PURCHASE	2	10 1/4	15	DOUBLE	ROPE STRAPS	248	3/4		
• PURCHASE	2	10 1/4	15	DOUBLE	AND QUARTER BLOCKS	256	3/4		
• PURCHASE	2	10 1/4	15	DOUBLE	ROPE STRAPS	360	7/8	16	1 1/8

WORKS PROGRESS ADMINISTRATION
SMITHSONIAN INSTITUTION
U. S. NATIONAL MUSEUM

REGISTERED LENGTH 221 FEET
BREADTH 42 "
DEPTH 17 "

KOKO HEAD

NAME OF VESSEL

REGISTRY NO. 161895
GROSS TONNAGE 1084.67
NET 1011

SURVEY NO. 16-44
INDEX NO. 1011

HISTORIC AMERICAN MERCHANT MARINE SURVEY
SHEET 2 OF 2 SHEETS

W. PHILLIPS DEL.

Fig. 4.7.25

PIN RAIL DIAGRAM

Fig. 4.7.26

Bark *EMILY F. WHITNEY*

This is a schematic diagram whose sole intention is to show where various lines are tied down at the rail. No scale is stated, and such a drawing needn't be strictly to scale.

Delineation

The schematic nature of the drawing is borne out well by its delineation.

Lettering is large and clear, but notes and headings should have been more distinguished graphically from labels. Heavier, bolder lettering for headings in addition to underlining would have helped a user find his way around the verbiage.

The arrows are essential, but a different method of drawing them would have made them less like the schematic linework and less likely to be confused with it. Why not draw such arrows with lighter line weights, or use a dashed or slightly curved line? This would make the arrows subordinate to the schematic linework and less competitive with it graphically.

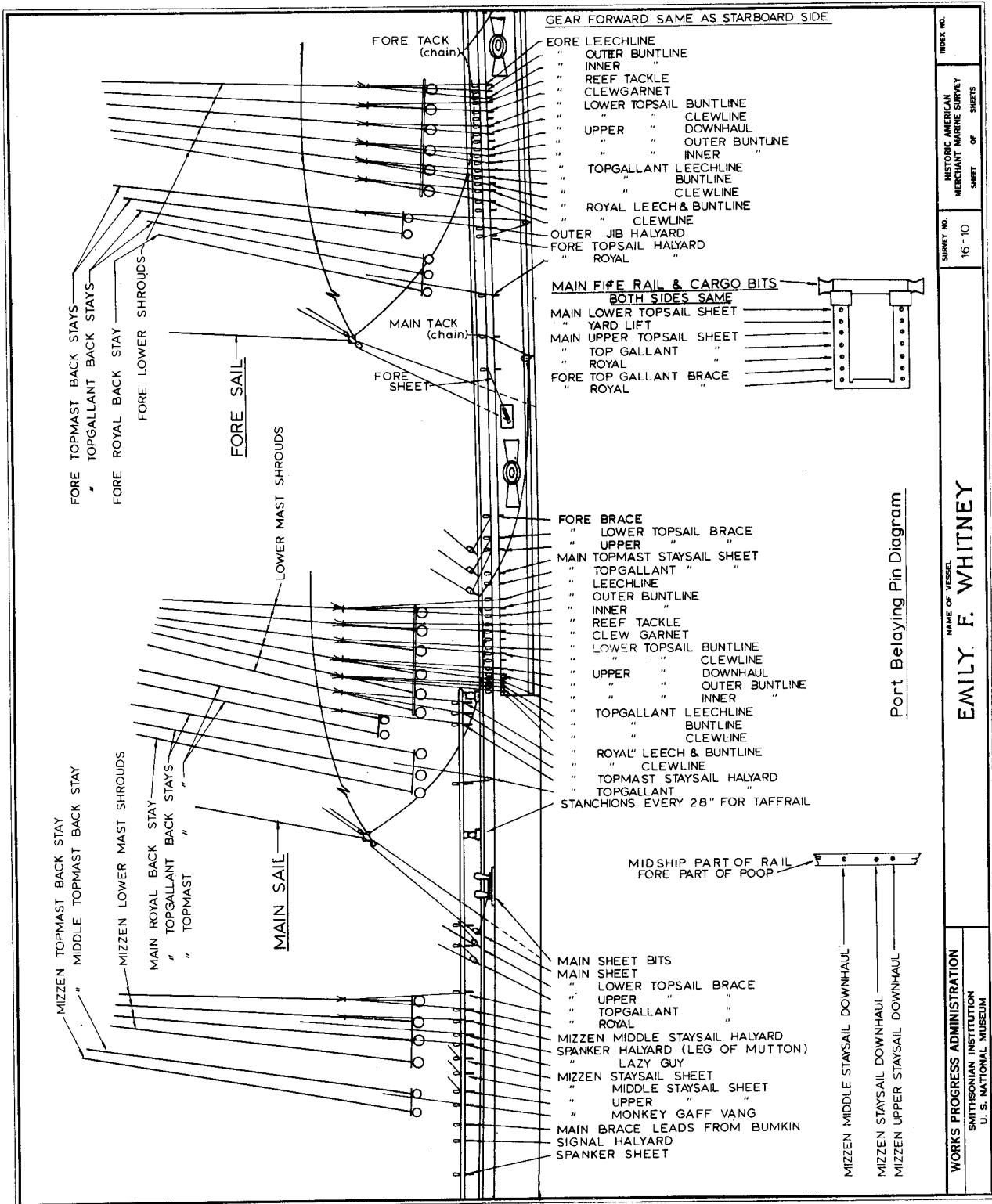

Fig. 4.7.26

MIZZENMAST

Figs. 4.7.27 - 4.7.29

Ship *BALCLUTHA*

Mast and rigging drawings such as these are used to show not only the mast and spars, but also standing rigging and details.

Layout

Three sheets were used in order to present the mast and rigging at a reasonable scale and give room for documentary notes.

The mast is shown with its true rake on the first sheet, but no rake on the second and third sheets. This makes splicing difficult.

Although the upper-topsail lift on the third sheet extends below the bottom match line, it has been shown in one piece for clarity.

Note the use of location diagrams to orient the user to the place of the drawing aboard the ship.

Delineation

Drawing reads well due to use of shadowed lines and a variety of line weights.

These drawings are reproductions made by photographically duplicating the original oversized drawing and splicing each portion into a HAER sheet. After lettering was added, each sheet was photographically recopied as a whole to eliminate non-archival splicing. Some fine lines have not reproduced clearly; choose line weights carefully.

Documentation

Rotated sections of each spar were included, but none for the mast, as should have been.

Most notes and the key appear on the first sheet. Though this is noted on the other sheets, the drawings would be easier to use if the key appeared on each sheet.

Recent repairs and changes are noted.

Notes indicate other sheets where further information may be found.

Mast height dimensions are presented in a table on the third sheet; overall heights have been dimensioned.

Error tolerances in field measurement have been noted.

MIZZENMAST

SHEET 1 OF 3

Scale: 3/8" = 1'-0"

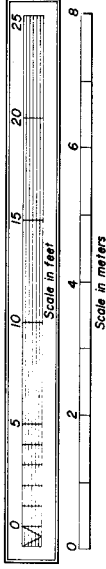

NOTES

- A. The mizzenmast is raked 6 degrees.
- B. The cross-back (crojlk) has not been shown. This sail was generally not carried although historic photographs indicate that BALCALUTHA carried one around the turn of the century.
- C. Doubling plates were added to the lower masts in 1955.
- D. Lower shroud fairleads (not shown) are not in place (1989). See foremast, sheet 45 for typical location.
- E. See sheet 51 for mast collar and mast step details.
- F. Approximately 60 feet of the topmast was replaced in 1978.
- G. The mizzen-top is a semi-circular platform of wood and iron built on trestle-trees at the hounds of the lower mast, spreading the topmast rigging and forming a work space for men aloft. It is supported by the cheeks, trestle-trees and cross-trees.
- H. In 1955, 6 to 8 feet were burned off each steel yard-arm, and the original fittings removed. New tapered ends were rolled, welded into place and the old fittings re-installed.
- I. Eumelis Fluid Film was sprayed on the interior of the steel yards ca. 1975 to prevent oxidation.
- J. Topmast cross-trees: the combination of trestle-trees, bolster, cross-trees and spreaders.
- K. The topgallant and royal masts were replaced in 1976.
- L. The upper-topmast, and royal yards, and the sparker-gaff were replaced in 1955. All wooden yards were replaced in the 1970's.
- M. The portside lifts and foot-ropes are not shown.
- N. The lifts, foot-ropes, braces, and the eyes of the shrouds, stays, backstays, and halliards are parceled and served as weather protection.

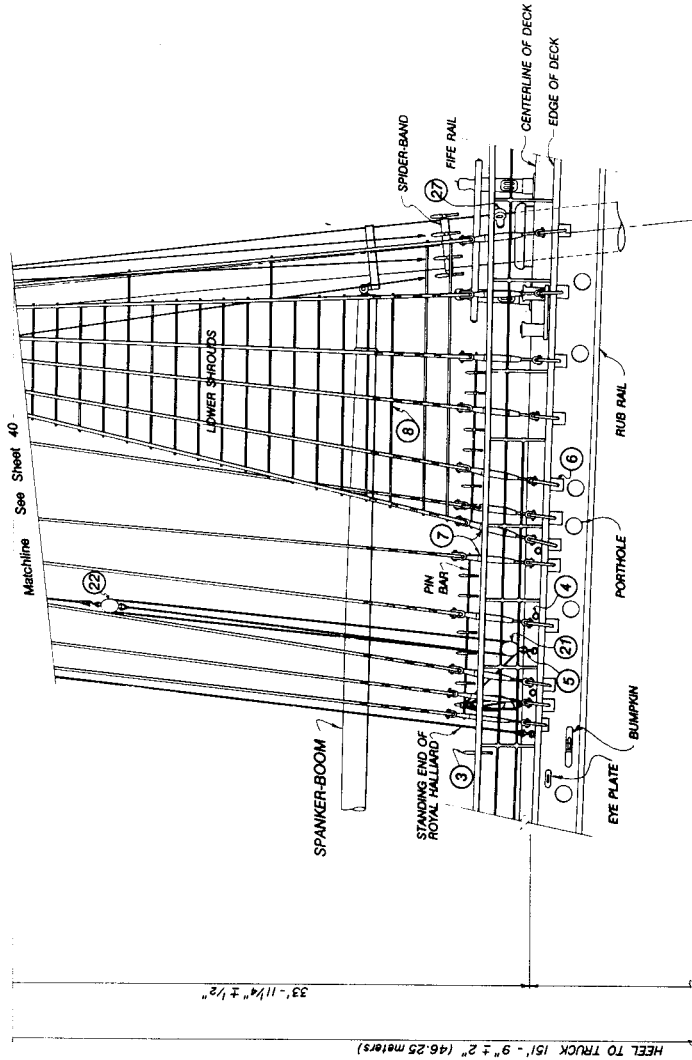
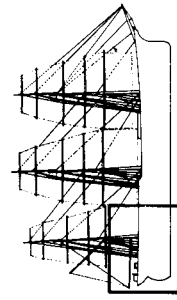

- ### KEY
- 1. PAD EYE
 - 2. BELAYING PIN
 - 3. SHACKLE
 - 4. CHAIN-PLATE
 - 5. TURNBUCKLE
 - 6. RATLINE
 - 7. CATCH RATLINE (Typically every 50' or 60' RATLINE)
 - 8. THUMB CLEAT
 - 9. FIGGING CLEAT
 - 10. FIGGING SHROUDS
 - 11. CHEEK
 - 12. TRESTLE-TREES
 - 13. CROSS-TREES
 - 14. BOLSTER
 - 15. TOPGALLANT FITTOCK
 - 16. SHROUDS
 - 17. UPPER-TOPSAIL PARREL
 - 18. TOPGALLANT PARREL
 - 19. TRIPLE BLOCK
 - 20. DOUBLE BLOCK
 - 21. SHEET BLOCK
 - 22. SHEET BLOCK
 - 23. GUN BLOCK
 - 24. CHEEK BLOCK
 - 25. FAIRLEAD BAND
 - 26. SADDLE FAIRLEAD BAND
 - 27. YARDARM BAND
 - 28. BAND
 - 29. FAIRLEAD ARM
 - 30. JACK-ROD
 - 31. JACK-STAY
 - 32. JACK-STAY EYEBOLT
 - 33. 'YALCOON'
 - 34. STRIRUP
 - 35. FOOT-ROPE
 - 36. LIFT
 - 37. MAST-STROP
 - 38. SHEAVE (DASHED)
 - 39. FUNNEL

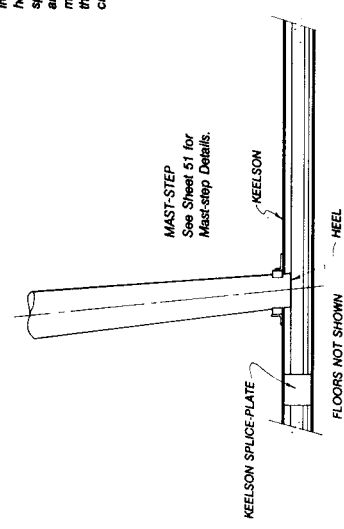
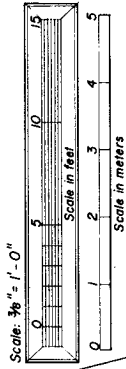

Fig. 4.7.27

MIZZENMAST

SHEET 2 OF 3



See sheet 39 for NOTES and KEY.

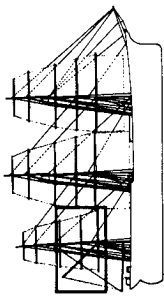
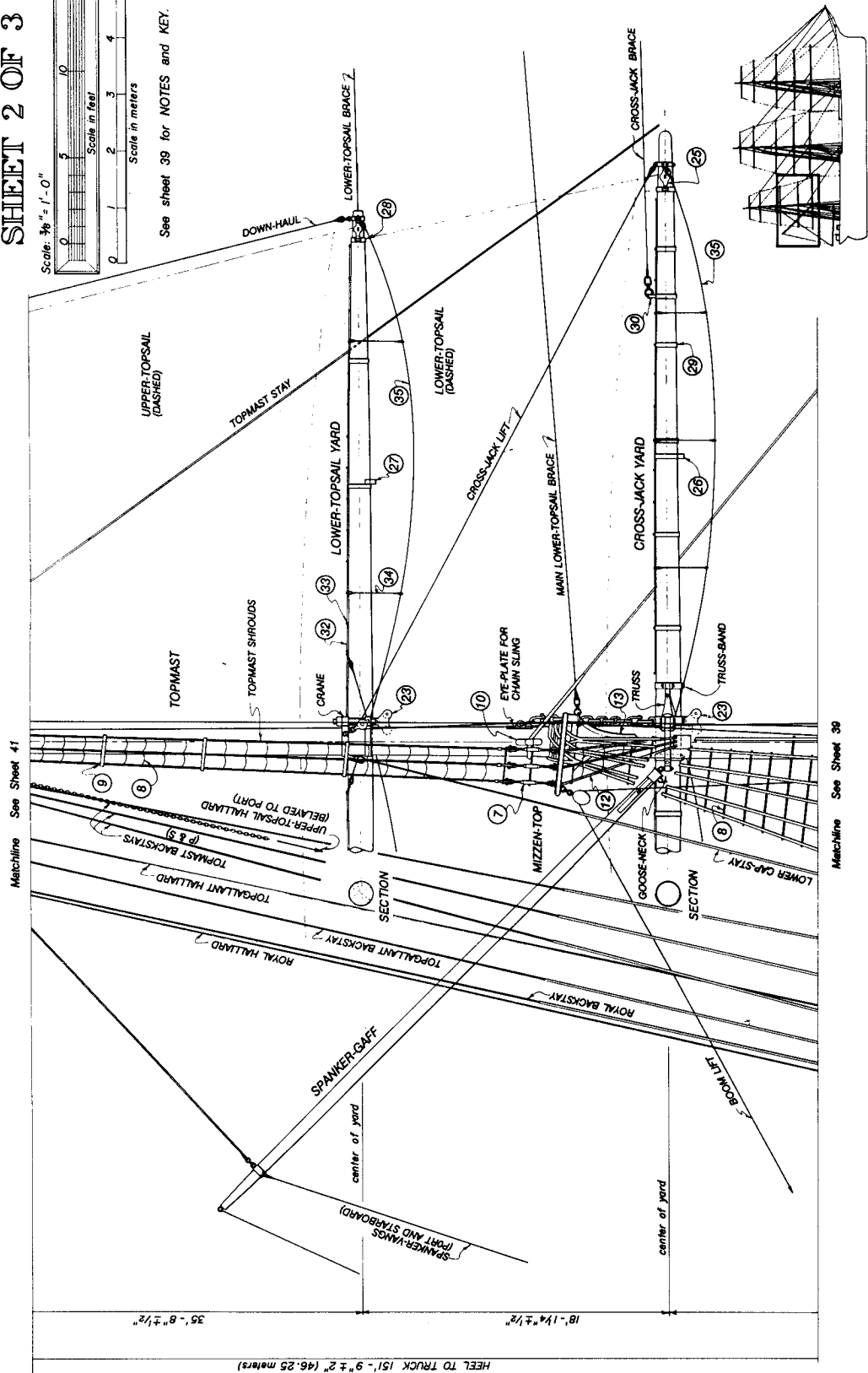
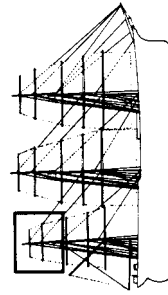
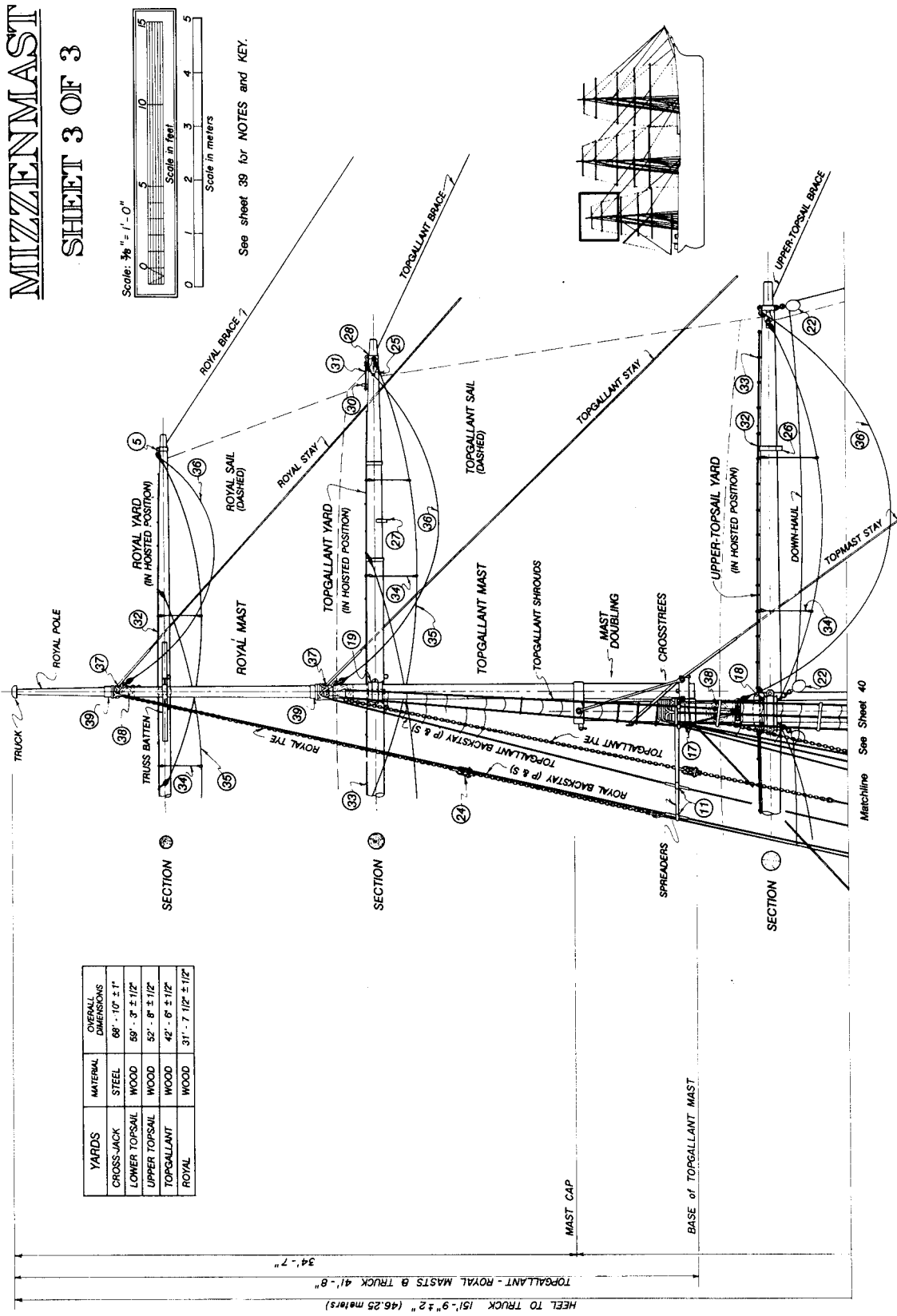

Fig. 4.7.28

MIZZENMAST

SHEET 3 OF 3

YARDS	MATERIAL	OVERALL DIMENSIONS
CROSS-JACK	STEEL	68' - 10" ± 1"
LOWER TOPSAIL	WOOD	69' - 3" ± 1/2"
UPPER TOPSAIL	WOOD	52' - 8" ± 1/2"
TOPGALLANT	WOOD	42' - 6" ± 1/2"
ROYAL	WOOD	31' - 7 1/2" ± 1/2"



SHIP "BALCLUTHA" (1886)
 SAN FRANCISCO MARITIME NATIONAL HISTORICAL SOCIETY
 SAN FRANCISCO
 CALIFORNIA
 SHEET 41 OF 69
 HISTORIC AMERICAN ENGINEERING RECORD
 CA - 54
 DEVELOPED BY Robbyn L. Johnson, 1988, 1990
 SHIP "BALCLUTHA" RECORDING PROJECT
 UNITED STATES DEPARTMENT OF THE INTERIOR
 BUREAU OF LAND MANAGEMENT
 IF REPRODUCED, PLEASE CREDIT: HISTORIC AMERICAN ENGINEERING RECORD, NATIONAL PARK SERVICE, NAME OF DELINEATOR, DATE OF THE DRAWING

Fig. 4.7.29

MAIN MAST AND SPARS

Fig. 4.7.30

Schooner *LETTIE G. HOWARD*

The mast and spars of this vessel were already unshipped at the time of documentation. Since the project agreement required "as-is" documentation, rigging has been shown, though the whereabouts of pre-existing photographic documentation is noted.

Layout

The sheet is balanced, though the notes appear slightly off-center.

Enlarged details are placed close to their actual locations on the mast.

A portion of the lower mast has been omitted so that the topmast can be included in this view.

Delineation

Line weights are varied, and shadowing has been used.

Hand lettering is neat, but should have been larger.

Documentation

This drawing is a partial reconstruction, which has been noted. It could have been extended, however, based on known schooner rig details and earlier documentation of the vessel's rigging.

Some assumptions about the indications of paint and rust marks are noted.

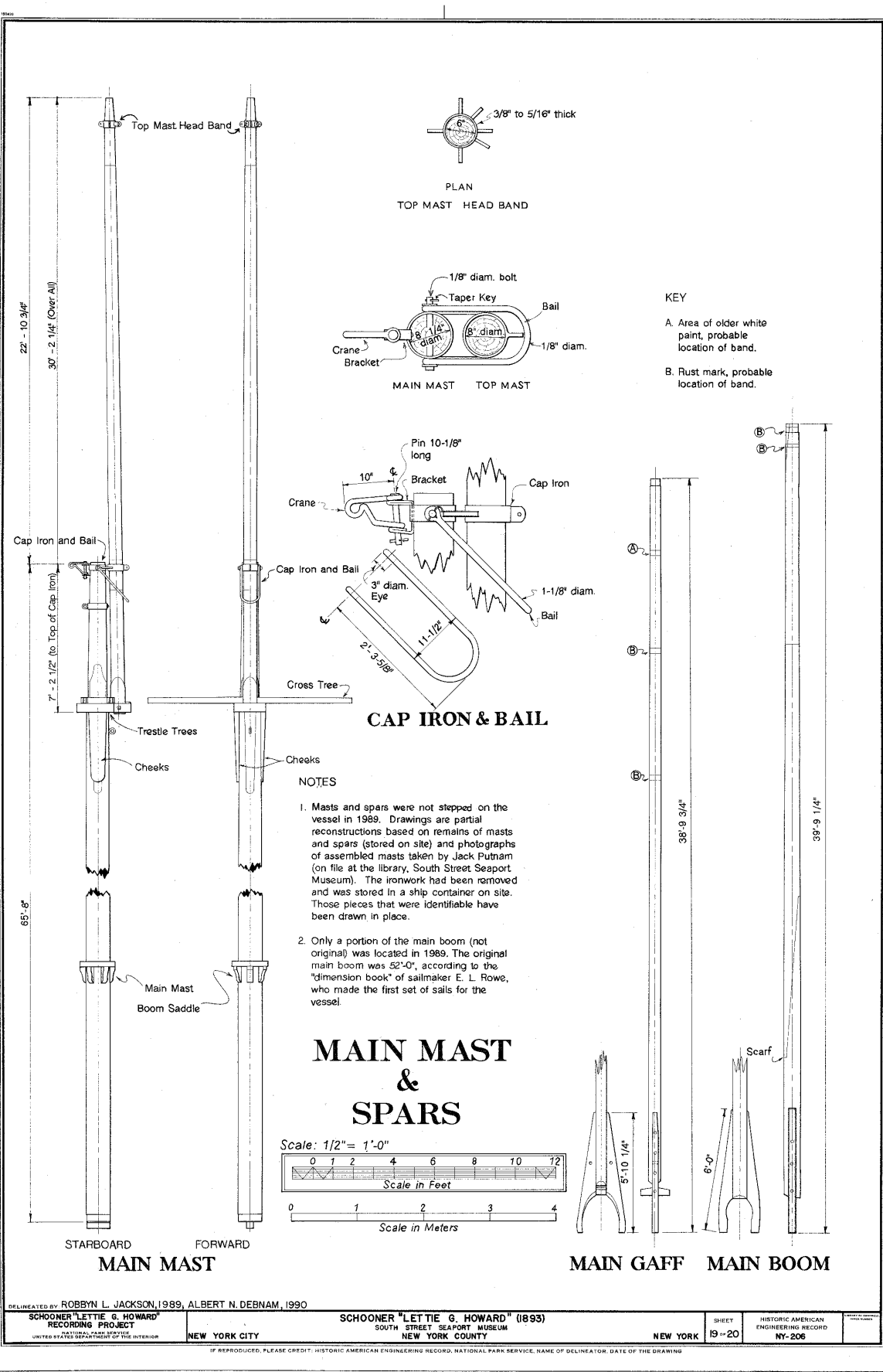

Fig. 4.7.30

STRUCTURAL DETAILS

Fig. 4.7.31

Ship *BALCLUTHA*

Layout

This sheet is very full and shows very different parts of the vessel's structure. It would have been better to use three sheets: first, a sheet of rivetted joint details showing regular butt straps, jogged plating and rivet patterns; second, a sheet of structural details showing a stringer, sister keelson, and keelson/floor/keel; third, a sheet of mast collar details. Each sheet would have had enough space for more descriptive notes and location keys.

Although this sheet is of various structural details, a user might well mistake them all for mizzen mast details since it is the only large title on the sheet.

A drawing showing the relationship among the stringer, keelson and sister keelson would have been helpful.

Delineation

Line weights, shadowing and pochés of cut materials have been incorporated, giving clarity to the drawings.

Isometric views tell more than orthographic plans and sections.

Documentation

The general structural details have not been prominently labeled as such, and may be easily confused with mizzenmast details.

Notes state where scantlings were taken, and what materials were identified.

Later additions to the vessel are noted.

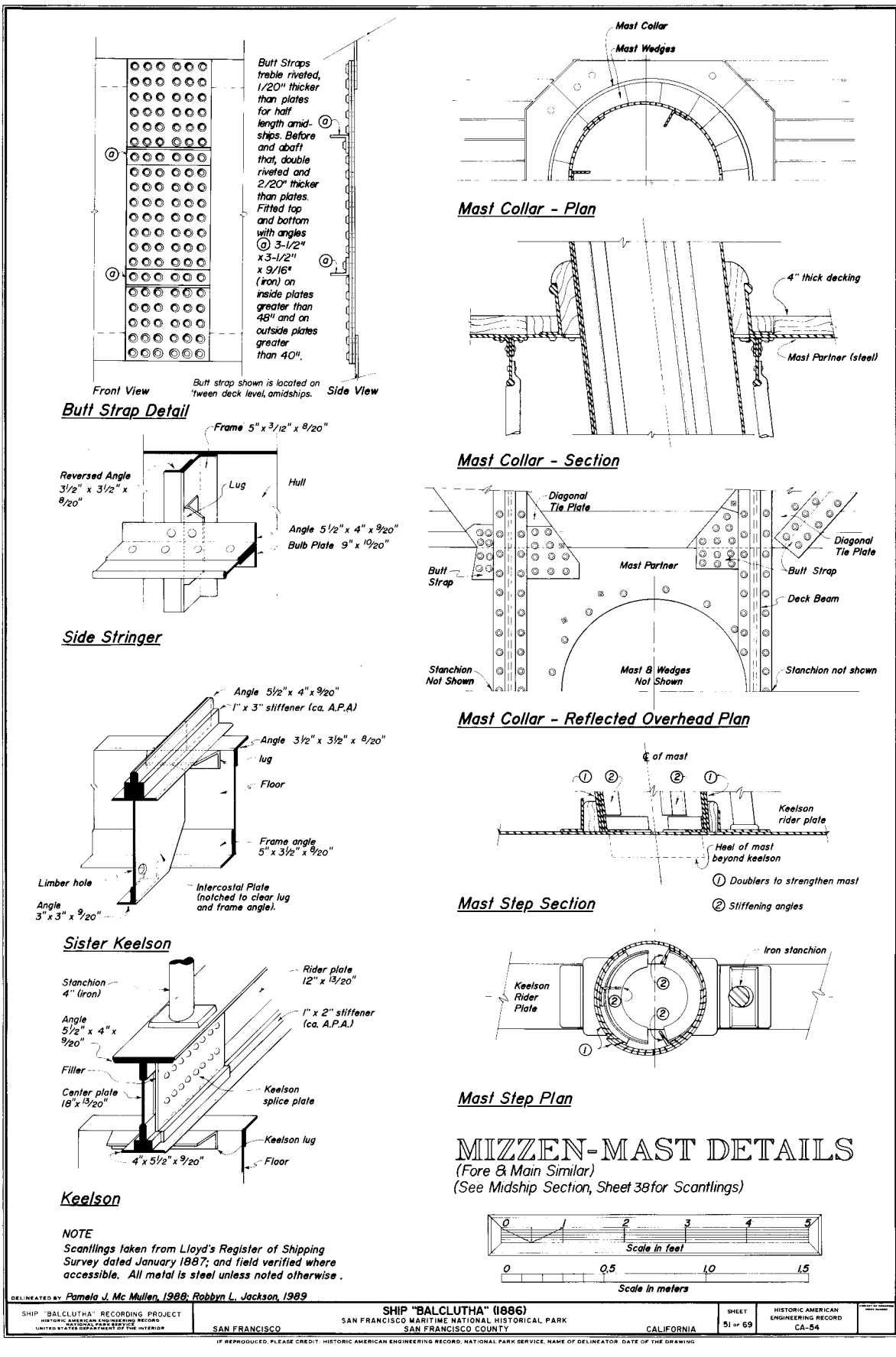

Fig. 4.7.31

STRUCTURAL DETAILS

Fig. 4.7.32

Bugeye *LOUISE TRAVERS*

This vessel was in such bad repair at the time of her documentation that she was deemed unrestorable. Consequently, the HAER team was able to disassemble portions of the vessel for detailed structural documentation. Further field work was done on the vessel's remains after she was burned. This rather archeological approach is unusual on HAER projects.

Layout

This sheet is well laid out, with a good balance between the drawings and the text.

The exploded isometric drawings are spaced well, separated enough to be distinct, but aligned with each other for clarity.

Blocks of text follow the curve of the futtocks in the upper drawings and the angle of the keel in the lower drawings.

Delineation

Line weights are used to differentiate a hierarchy of elements.

The wood has been pochéd to show the actual grain direction, and this has been annotated so that a user cannot mistake it for generic rendering techniques.

The stern and duck tail drawing leaves the user uncertain as to whether some structural elements (knee, shaft log) are inside or outside of the hull. The ghost lines don't do their job well enough.

Documentation

Everything has been extensively documented as to what was and wasn't observed in the field.

Sizes and materials of hardware and fastenings have been noted wherever it was possible to obtain them.

All pieces are identified; labels are close where possible, keyed where they would obscure detail. Arrows are used to make positive identification between labels (or number tags) and indicated parts.

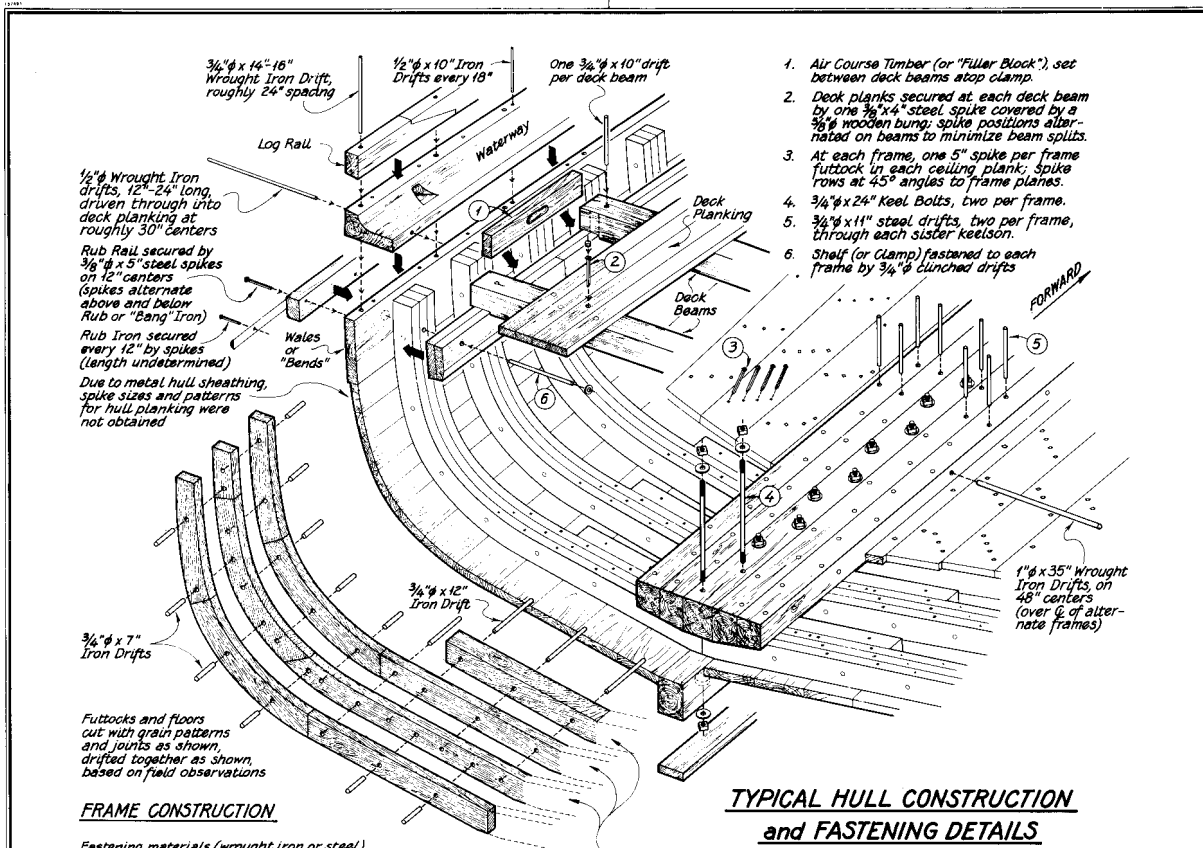

FRAME CONSTRUCTION

Fastening materials (wrought iron or steel) identified by their characteristic corrosion patterns where enough of fastening length could be examined

The presence or absence of centerline butt joints in these three floors was not field checked due to time and access limitations.

TYPICAL HULL CONSTRUCTION and FASTENING DETAILS

(NO SCALE)

Construction details shown above observed in field during disassembly of vessel remains

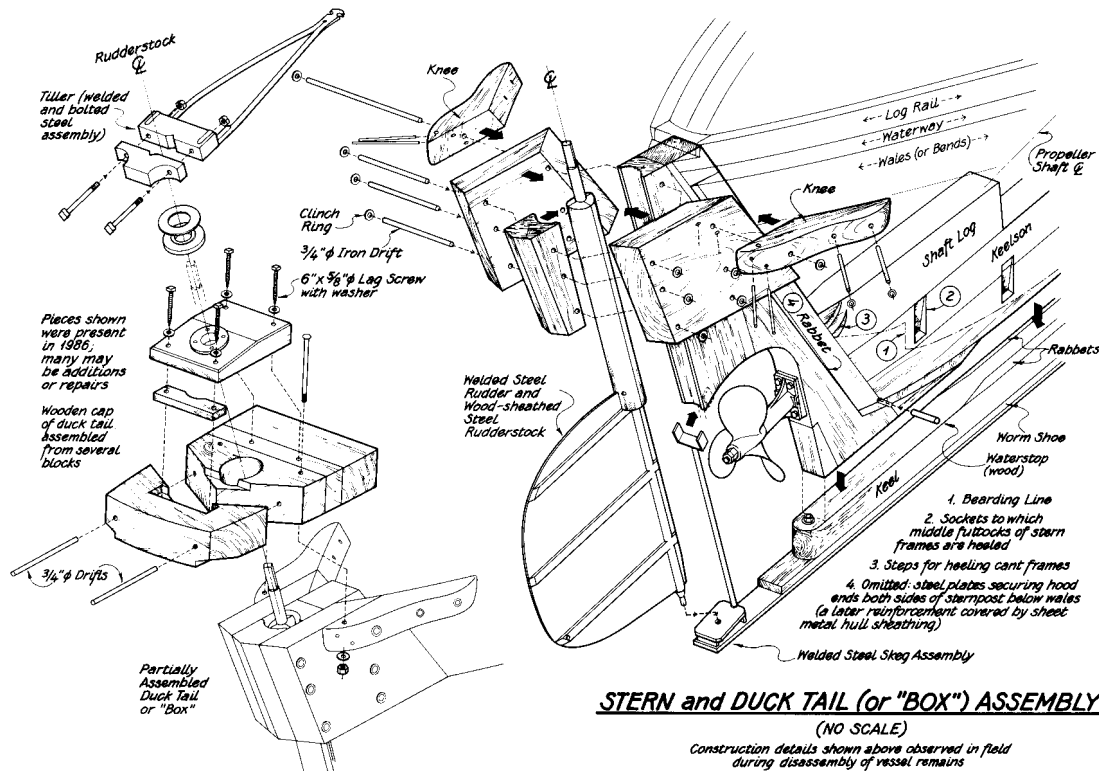

STERN and DUCK TAIL (or "BOX") ASSEMBLY

(NO SCALE)

Construction details shown above observed in field during disassembly of vessel remains

DELINEATED BY *Richard K. Anderson, Jr.*, 1990

LOUISE TRAVERS RECORDING PROJECT
NATIONAL PARK SERVICE
UNITED STATES DEPARTMENT OF THE INTERIOR

SOLOMONS

BUGEYE "LOUISE TRAVERS" (1896)
CALVERT MARINE MUSEUM, INTERSECTION OF STATE ROUTES 2 & 4
CALVERT COUNTY

MARYLAND

SHEET
13 of 13

HISTORIC AMERICAN
ENGINEERING RECORD
MD-55

IF REPRODUCED, PLEASE CREDIT: HISTORIC AMERICAN ENGINEERING RECORD, NATIONAL PARK SERVICE, NAME OF DELINEATOR, DATE OF THE DRAWING

Fig. 4.7.32

MACHINERY AND JOINERY DETAILS

Fig. 4.7.33

Ship *BALCLUTHA*

Layout

The various views have been placed to correspond to each other as much as possible.

Delineation

A variety of line weights makes this drawing read; note the heavier lines at the edges of cut materials. Details have been delineated with finer lines. Pochés denote cut materials and shadowing creates a sense of depth, especially in the lattice seat of the bench.

Different lettering sizes differentiate "parts" labels, "view" labels, and the "title" label.

Documentation

Although labels denote various parts, not much explains how the steering gear worked, obviously because there was no space for the text. Although the gear is patented, detailed information may be hard to find in the future. A single sheet devoted to just the mechanism may have been a more thorough treatment.

Basic dimensions are given, but not all the details are drawn at the same scale, and the differing scales are not clearly noted.

Some, but not all, materials are noted.

TRIM LINE

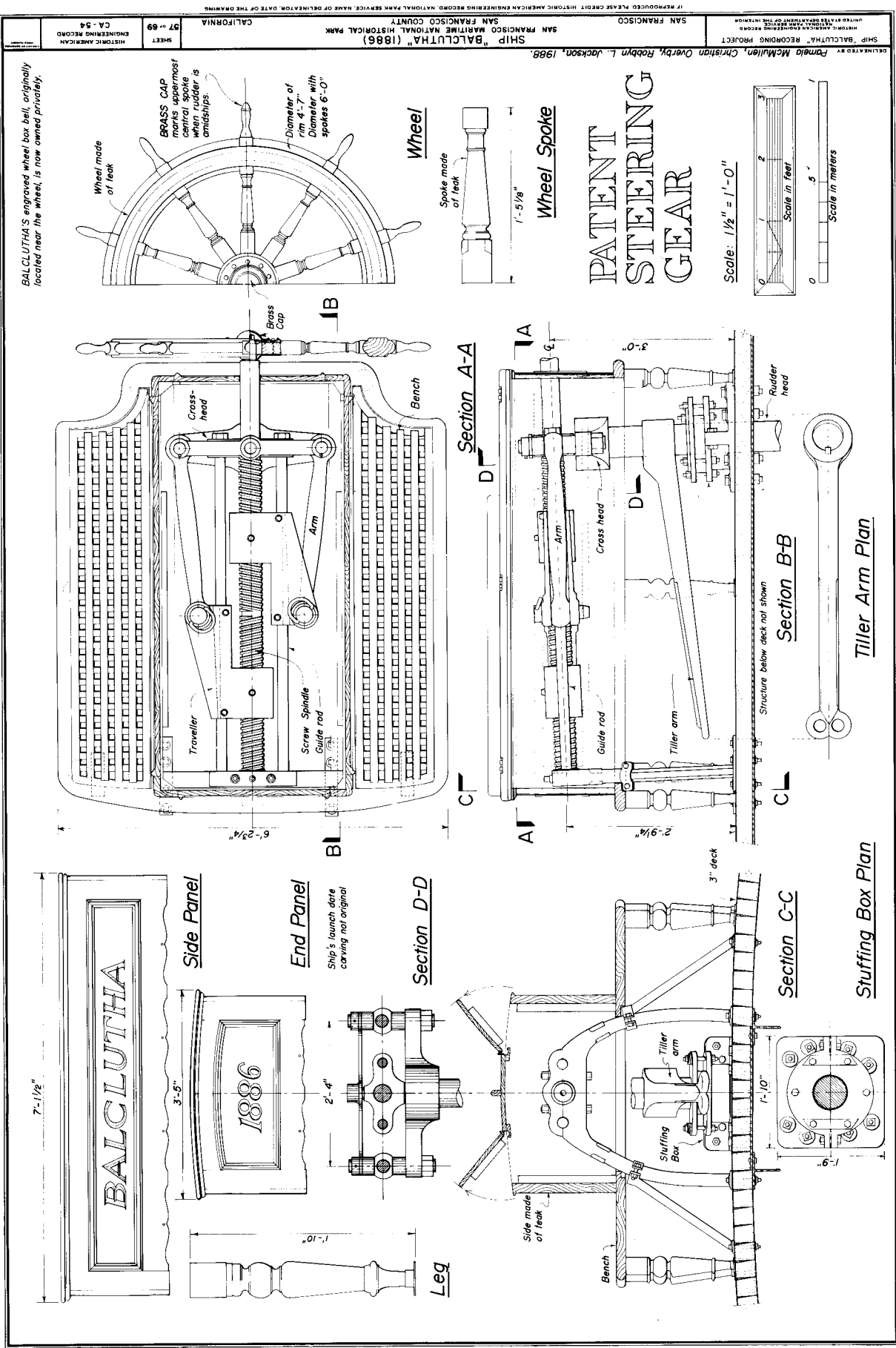

TRIM LINE

Fig. 4.7.33

JOINERY DETAILS

Fig. 4.7.34

Ship *BALCLUTHA*

Layout

The details on this sheet have been placed to correspond as closely as possible to their locations on the elevation of the saloon door. The plan is below, the jamb and profile to the sides, the lintel above. The capital of the engaged column is next to the smaller profile, and its face is just below.

Delineation

A variety of line weights and pochés express the elegance of the joinery.

Documentation

Some elements are labeled, some are not. Why?

For further visual detail, notes refer the user to HAER large format photographs.

Notes say that the door lintel is drawn 3/4 full size and that the capital is drawn full size. In reduction, these statements are incorrect. Dimension lines would have permitted users to scale these drawings without guesswork or round-about comparison with other drawings.

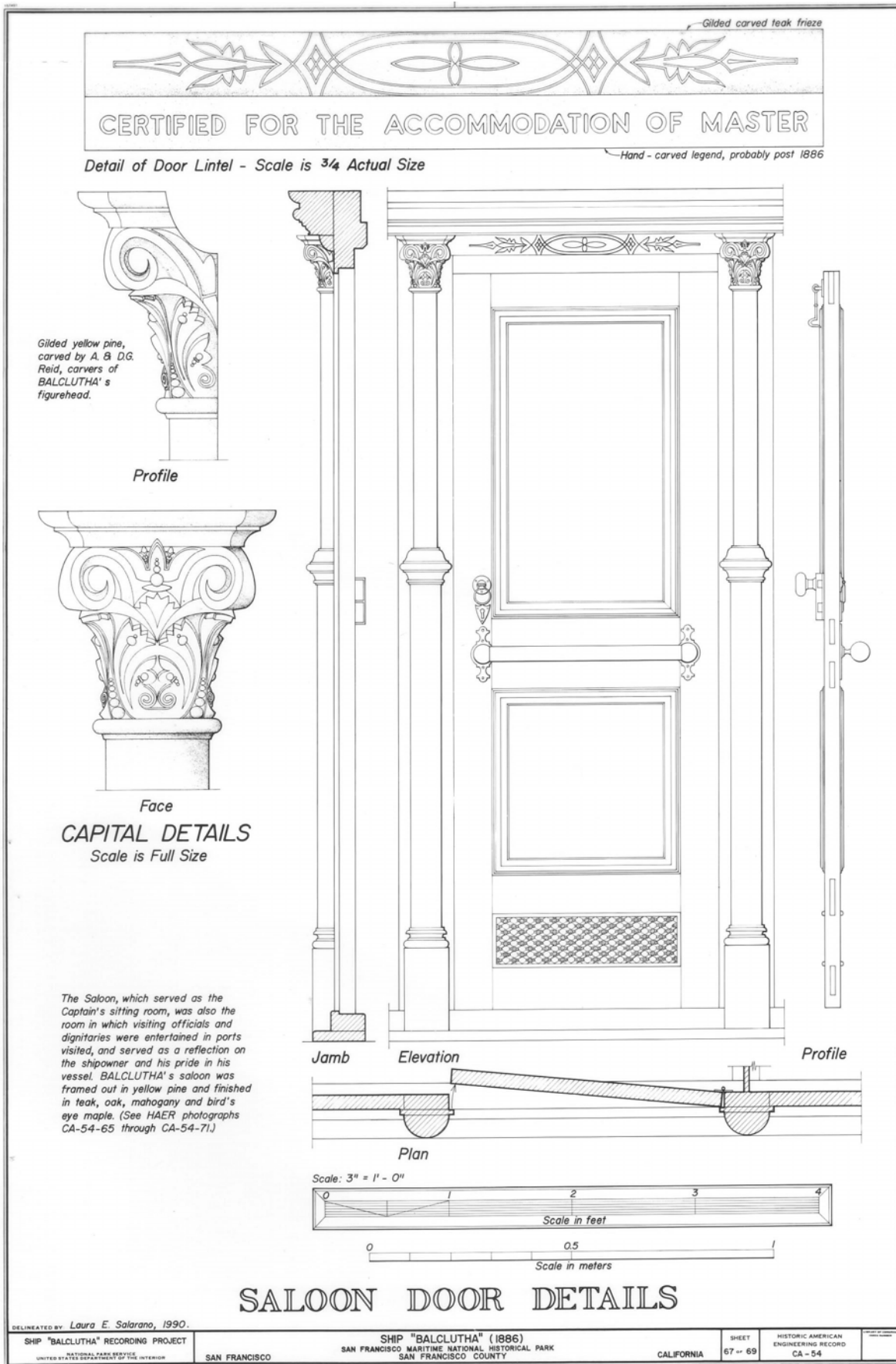

Fig. 4.7.34

MACHINERY DETAILS

Fig. 4.7.35

Engine, Cutter *GJOA*

Layout

Standard three-view mechanical drawing.

Delineation

Delineation is very clean and precise--no overruns, mismatched curves and tangents, awkward or sloppy details--however, overall effect is flat and lifeless. Some judicious outlining with a heavier line, or use of line shading would improve the character (without much extra labor, had it been done at first).

Lettering is too small and too faint for view titles, sheet title, and graphic scale.

Documentation

This drawing shows in great detail what a "13-horsepower 'Dan' type petroleum engine" looks like, but a lot of important information is not addressed:

- Which way was the engine mounted?
- What RPM range did it run at?
- What was cylinder bore and stroke?
- What direction did the flywheel rotate (or was it reversible)?
- Who built the engine? when? where?
- When was it installed in the vessel?
- What are the names of some of the principal parts?
- Where are the connections for fuel, air, and exhaust?
- Are any parts missing that would ordinarily be installed on an operating engine of this type?

Recorders should annotate drawings with this sort of information, giving users references for further levels of detail. Omissions should be accounted for in some manner, even if the reason is lack of resources.

The drawing does not state if it is based on any pre-existing engineering drawings of this type of engine.

It appears that the connecting rods, cranks, and counterweights are missing in the drawing--a not inconsiderable oversight.

Principal dimensions should be shown.

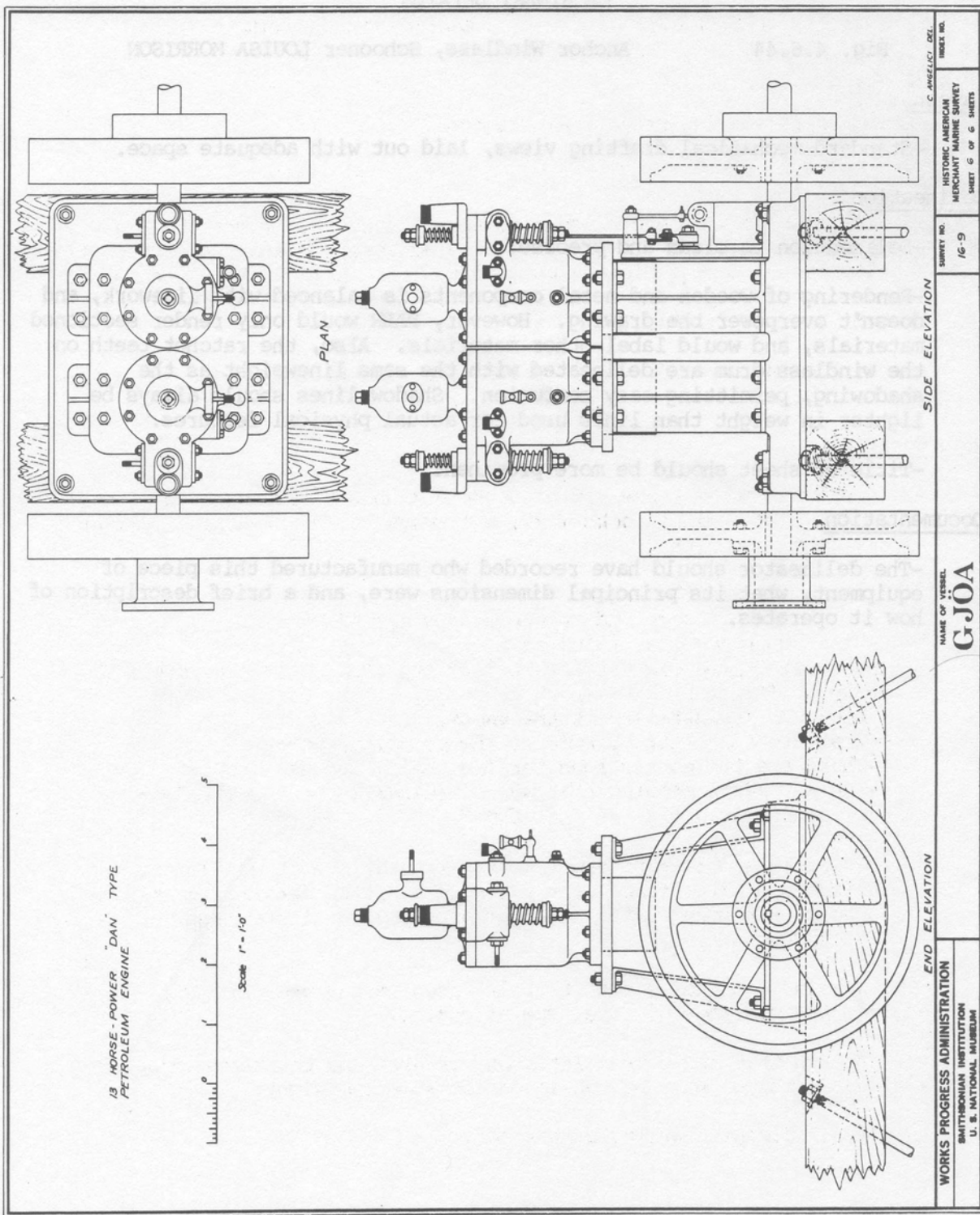

Fig. 4.7.35

MACHINERY DETAILS

Fig. 4.7.36

Donkey Engine, Schooner *COMMERCE*

Layout

The two views shown are a bit cramped. No plan view is shown.

Delineation

This drawing reads boldly, but the effect is achieved at the expense of time-consuming rendering which often obscures details (plank joints, phantom views of gears, etc.). An unintentional result of this treatment is that the flat-sided metal feedwater tank (extreme left) reads completely as a void, not a feature. (Flat metal surfaces can be stippled to denote a solid plane.) Some rendering shown here is useful, such as that for the boiler barrel and other rounded features (avoid it on small piping).

Some delineation is crude (in part due to the characteristics of vellums).

Documentation

Lack of principal dimensions and annotations reduces this drawing to showing a user how something looks but not much else. So much more can be added by appropriate notes and labels:

- Who built the engine and boiler? when? where?
- When was it installed in the vessel?
- What are the principal specifications on the boiler (operating pressure, heating area, fuel, etc.)?
- What were the bore and stroke of the cylinders?
- What are the names of some of the principal parts?
- What uses was the donkey engine put to aboard the *COMMERCE*?

Plan view of assembly is missing.

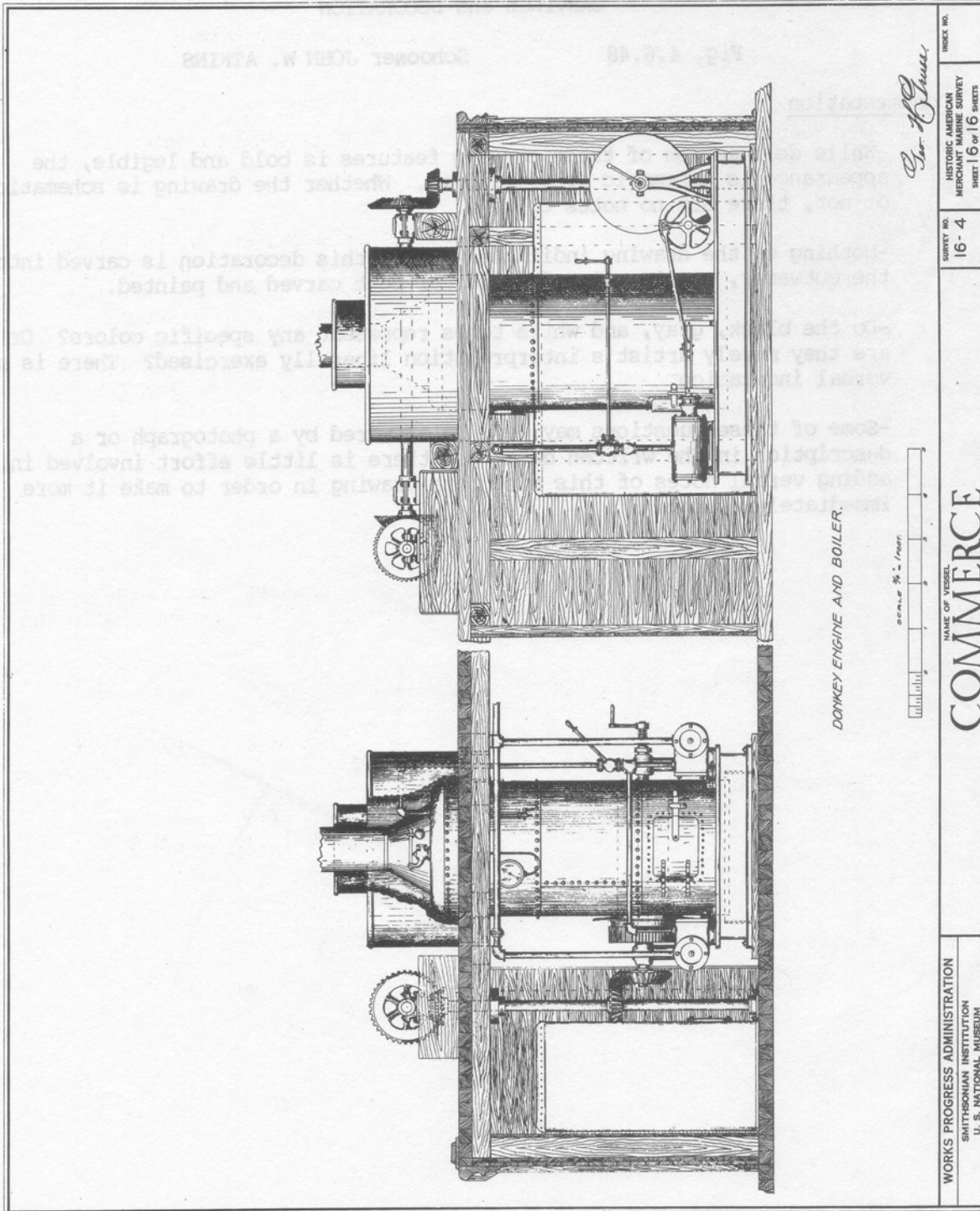

WORKS PROGRESS ADMINISTRATION SMITHSONIAN INSTITUTION U. S. NATIONAL MUSEUM	NAME OF VESSEL COMMERCE	SURVEY NO. 16-4	HISTORIC AMERICAN MERCHANT MARINE SURVEY SHEET 16 OF 16 SHEETS
---	-----------------------------------	---------------------------	--

Fig. 4.7.36

MACHINERY DETAILS

Fig. 4.7.37

Ship *FALLS OF CLYDE*

This is an interpretive drawing, done to illustrate the cargo and ballast pumping system in a manner much more readable than plans or sections. In drawings such as this, distracting elements such as framing members can be omitted for clarity, and other elements can be elongated or foreshortened to avoid obscuring important features. Accurate plan and section drawings should be completed also.

Layout

The drawing uses the available space well. The detail in the upper right balances the title in the lower left.

The pumps have been identified as to their size, capacity and manufacturer. Only enough details has been shown on the pumps and valves to adequately express their function.

Delineation

Some indication of the shape of the ship's hull would add to this drawing.

Dashed lines in the shape of a box denote a missing pump. No documentation was available on the pump's size or appearance.

The use of shadow lines enhances the third dimension of this drawing.

Historic photographs helped in recreating some of the missing portions of the system; notes report their location and identity.

The lettering is large enough to read well when reduced.

Labels lie close to the parts they identify, but do not obscure line work.

Labels located on pipes would look better if their letters followed the curves of the pipes.

A location key diagram shows the location of the drawn area within the vessel.

The directions of flow in the ballast and cargo pipes should be indicated.

Documentation

MACHINERY DETAILS - SYSTEM SCHEMATICS

Fig. 4.7.38

Ship *FALLS OF CLYDE*

This 1989 HAER project documented only a portion of the *Falls of Clyde*: the boiler room, port and starboard tanks, and upper and lower pump rooms. An understanding of these areas would not be easy without information on the whole system. A schematic drawing is all that is needed in this case.

Layout

The cargo and ballast pumping system has been separated from the steam system in order to prevent confusion.

Rather than reduce the size of the drawings or crowd them together, the afterpeak of the upper isometric breaks the sheet border to give room for notes.

The key, notes and title rest in the corners of the drawing, balancing the sheet. The note in the upper right hand corner would work better if it had taken a triangular form to follow the angle of the isometric.

Delineation

Heavy lines bring out the most significant parts of the system while light lines indicate the context of the ship's hull.

Size and weight of lettering varies according to its function. Labels are keyed to the drawing so as not to obscure linework.

Documentation

The purpose of the steam system--to heat oil and molasses cargoes for easier pumping--has not been stated.

Locations keys have been included to show which are of the vessel is being shown.

Assumptions made by HAER have been noted, as well as sources on which they are based.

This schematic is not to scale, and that has been noted.

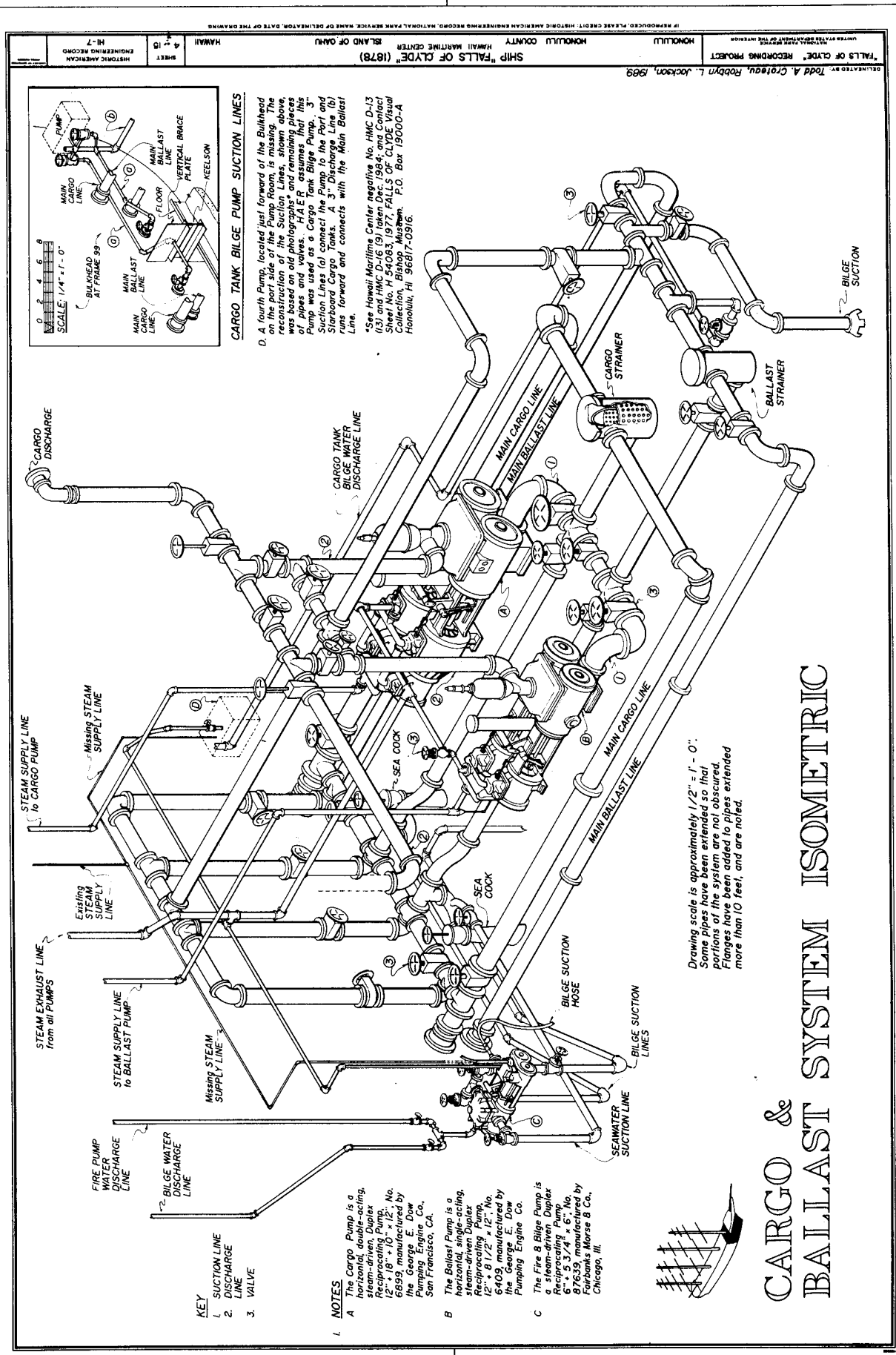

CARGO TANK BILGE PUMP SUCTION LINES

D. A fourth pump, located just forward of the Bulkhead on the port side of the Pump Room, is missing. The reconstruction of the Suction Lines, shown above, was based on old photographs* and remaining pieces of pipes and valves. H.A.E. Tank Systems had the Cargo Pump and the Fire & Bilge Pump. The Suction Lines (a) connect the Pump to the Port and Starboard Cargo Tanks. A 3" Discharge Line (b) runs forward and connects with the Main Ballast Line.

*See Hawaii Maritime Center negative No. HMC D-13 (13) and HMC D-16 (9) taken Dec. 1964; and Contact Sheet No. H 54083, 1977, FALLS OF CLYDE Visual Collection, Bishop, Maui, Hawaii. P.O. Box 19000-A Honolulu, HI 96817-0916.

- KEY**
1. SUCTION LINE
 2. DISCHARGE LINE
 3. VALVE
- NOTES**
- A The Cargo Pump is a horizontal, screw-driven, Duplex Reciprocating Pump, No. 12" x 18" x 10" x 12", No. 6889, manufactured by the George E. Dow Pumping Engine Co., San Francisco, Ca.
- B The Ballast Pump is a horizontal, single-acting, steam-driven Duplex Reciprocating Pump, No. 12" x 18" x 10" x 12", No. 6409, manufactured by the George E. Dow Pumping Engine Co.
- C The Fire & Bilge Pump is a horizontal, single-acting, steam-driven Duplex Reciprocating Pump, No. 6" x 5 3/4" x 6", No. 87639, manufactured by Fairbanks Morse & Co., Chicago, Ill.

Drawing scale is approximately 1/2" = 1' - 0".
 Some pipes have been extended so that portions of the system are not obscured.
 Flanges have been added to pipes extended more than 10 feet, and are noted.

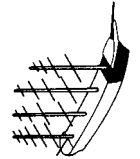

CARGO & BALLAST SYSTEM ISOMETRIC

Fig. 4.7.38

INTERPRETIVE DRAWINGS

Fig. 4.7.39

Two Sail Bateau (Skipjack) *E.C.COLLIER*

Layout

The layout takes advantage of the image shape to place title lettering, graphic scale and labels.

"Sheet 1 of 2" should have been reduced in size.

Delineation

A variety of line weights makes a clear and definite image. Cut materials have been rendered.

Water was rendered along one side of the drawing to reinforce the impression of the marine environment in which the oyster dredging equipment operated.

Hand lettering is clear, but larger letters would have been more legible, especially in the rendered area on the right.

Choice of axes and scales for this axonometric drawing creates a distorted view of the winder and rollers.

Documentation

Space did not permit a detailed description of dredging on this sheet, so readers are referred to the second sheet.

No description is offered or referred to concerning winder operation. Controls and other parts of the winder are not identified.

Although advantage is taken in this view to show some aspects of the vessel's construction, timbers are not sized or labeled in this drawing. The view is focused on the winder and its part in oyster dredging. Scantlings are covered elsewhere.

1INTERPRETIVE DRAWINGS

Fig. 4.7.40

Two Sail Bateau (Skipjack) *E.C.COLLIER*

Layout

This long, thin image lies diagonally across the sheet; explanatory paragraphs fill in opposite corners and balance the composition.

Text in the upper left is wrapped around the drawing. (It would have helped to do the same on the lower right.)

As with the first sheet "Sheet 2 of 2" is too large.

Delineation

Hand lettering is clear, but labels placed in the "water" are on the verge of losing their definition. Perhaps it is good that the verbiage blends nicely with the water rendering, but it does make labels harder to find.

Lettering style should have been modified to remain legible in reduction. The letter "E" is especially vulnerable to degradation, and many letters are bleeding together because they are too close together.

The oyster dredging process is described in detail in conjunction with a drawing of a dredge basket. Rollers are repeated to provide continuity with the winder on the first sheet.

Sources for information on dredging are cited at the end of the text.

Though an isometric scale is included, the axes on which the dredge basket is drawn are different from the scale. Scaling from the basket image is problematic.

Documentation

OYSTER DREDGING

SHEET 1 OF 2

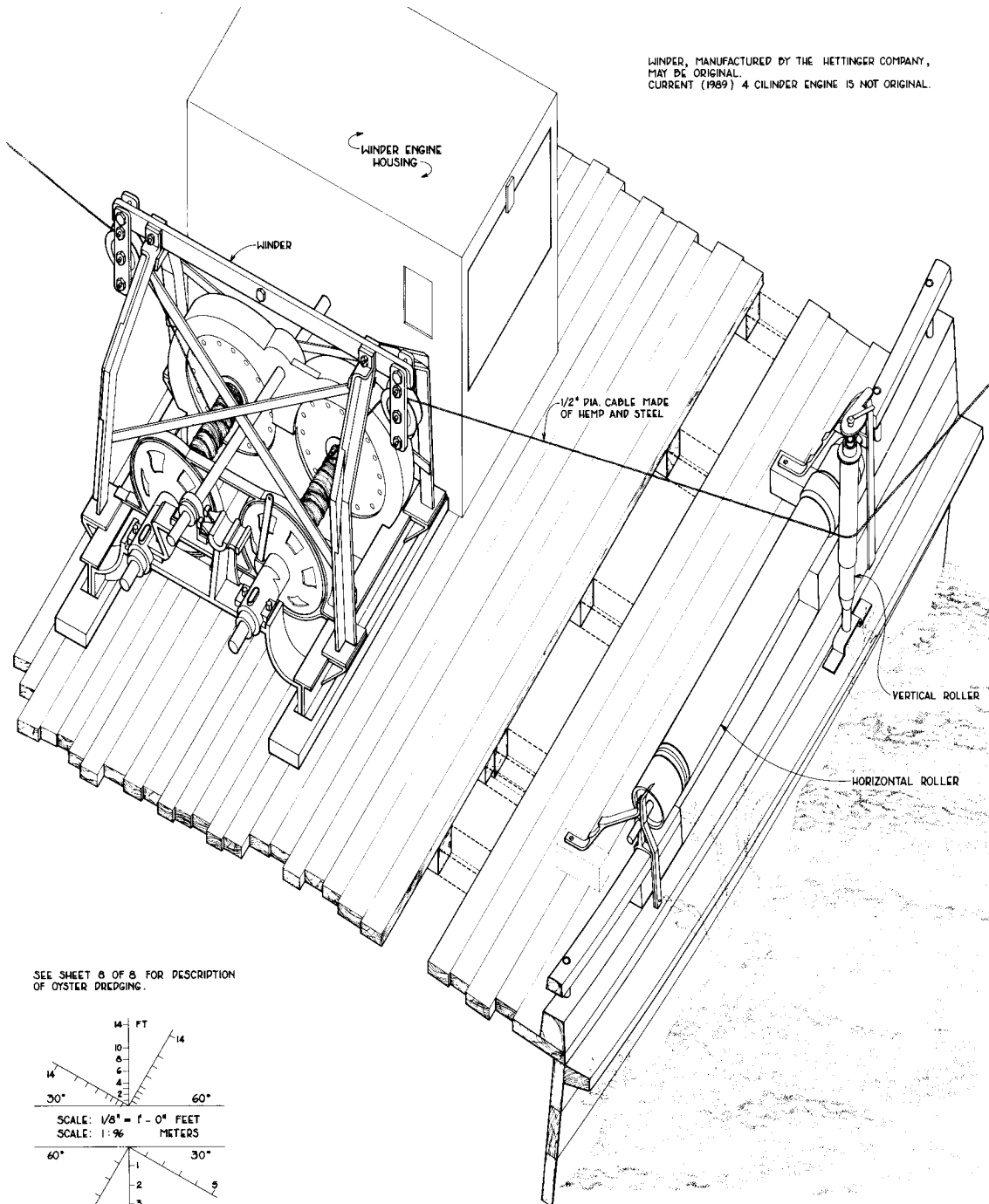

WINDER, MANUFACTURED BY THE HETTINGER COMPANY,
MAY BE ORIGINAL.
CURRENT (1989) 4 CYLINDER ENGINE IS NOT ORIGINAL.

SEE SHEET 8 OF 8 FOR DESCRIPTION
OF OYSTER DREDGING.

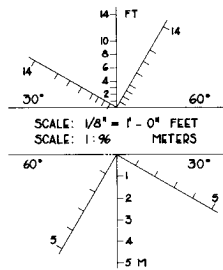

DELINEATED BY: ALAN S. MICHAELS - LAURA E. SALARANO - 1989 E. C. COLLIER RECORDING PROJECT <small>HISTORIC AMERICAN ENGINEERING RECORD UNITED STATES DEPARTMENT OF THE INTERIOR</small>		TWO SAIL BATEAU (SKIPJACK) E. C. COLLIER (1910) <small>MILL STREET AT NAVY POINT TALBOT COUNTY</small>		SHEET 7 OF 8	HISTORIC AMERICAN ENGINEERING RECORD MD-77
---	--	---	--	-----------------	--

IF REPRODUCED PLEASE CREDIT HISTORIC AMERICAN ENGINEERING RECORD, NATIONAL PARK SERVICE, NAME OF DELINEATOR, DATE OF THE DRAWING

Fig. 4.7.39

OYSTER DREDGING

SHEET 2 OF 2

OYSTERS ARE HARVESTED EACH YEAR FROM NOVEMBER 1st TO MARCH 15th, OFTEN UNDER EXTREMELY COLD AND WET CONDITIONS. THE OYSTERS ARE HARVESTED BY DREDGING, OR "DRUDGIN" AS IT IS REFERRED TO LOCALLY, DRAGGING A DREDGE BASKET ACROSS THE TOP OF SUBMERGED OYSTER BEDS. ON AVERAGE, THE SKIPJACKS CAN DREDGE ONLY TWO TO FOUR DAYS PER WEEK, BEING STOPPED FOR DAYS AT A TIME BY SQUALLS, COLD FRONTS AND/OR THICK ICE.

THE DREDGE BASKET CONSISTS OF A PYRAMIDAL STEEL FRAME WITH A CHAIN AND ROPE NET ATTACHED TO ITS BASE. A STEEL BAR WITH TINES SPACED APPROXIMATELY 3" ON CENTER IS ATTACHED TO THE FRAME AT THE MOUTH OF THE NET. THE SPACING AND LENGTH OF THE TINES DIFFER FROM BASKET TO BASKET, DEPENDING ON THE DIFFERENT DREDGING CONDITIONS. AS THE DREDGE BASKET IS DRAGGED ACROSS THE TOP OF THE SUBMERGED OYSTER BEDS, THE TINES LOOSEN THE OYSTERS, AND THE CATCH IS ACCUMULATED IN THE NET. THE VOLUME OF THE CATCH VARIES FROM RUN TO RUN WITH UP TO 70% OF THE BASKET'S CONTENTS BEING EMPTY SHELLS, TRASH, AND BOTTLES, AS WELL AS OYSTERS WHICH ARE BELOW THE 3" LEGAL LIMIT. THE TYPICAL BASKET WEIGHS APPROXIMATELY 200 LBS., SO THAT IT CAN SINK RAPIDLY TO THE BOTTOM, AND TAKES TWO MEN TO THROW OVERBOARD AND HAUL BACK ON DECK. EACH BOAT CARRIES TWO DREDGE BASKETS. TO KEEP THE BOAT BALANCED, BOTH BASKETS ARE DROPPED OVERBOARD AT THE SAME TIME, ONE FROM EACH SIDE, PORT AND STARBOARD, BOTH ARE DRAWN UP AT THE SAME TIME EXCEPT WHEN THE BOAT NEEDS TURNING. IN THIS CASE, ONLY ONE IS RAISED DEPENDING ON THE DIRECTION OF THE TURN, WITH THE SECOND BASKET BEING RAISED AFTER THE TURN IS COMPLETE. AFTER THE BASKETS ARE HAULED ON DECK, EVERYONE HELPS TO "CULL" THE CATCH. THE LEGAL OYSTERS ARE THROWN ON DECK, EITHER FORE OR AFT AND THE DREGS ARE SET ASIDE AND LATER DUMPED BACK INTO THE SAME BED THEY CAME FROM. THIS PROCESS IS REPEATED CONTINUALLY FROM EARLY MORNING UNTIL LATE AFTERNOON OR UNTIL THE 150 - BUSHEL DAILY LIMIT IS REACHED.

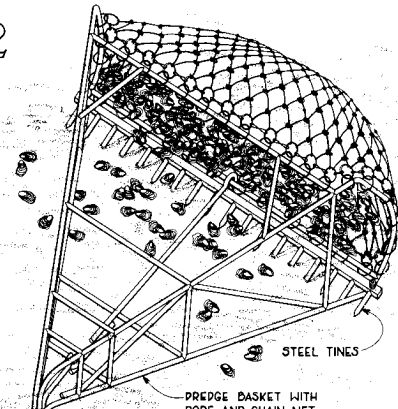

BASKET IS DEPICTED IN TYPICAL POSITION ON OYSTER BEDS, DRAGGED BEHIND BOAT

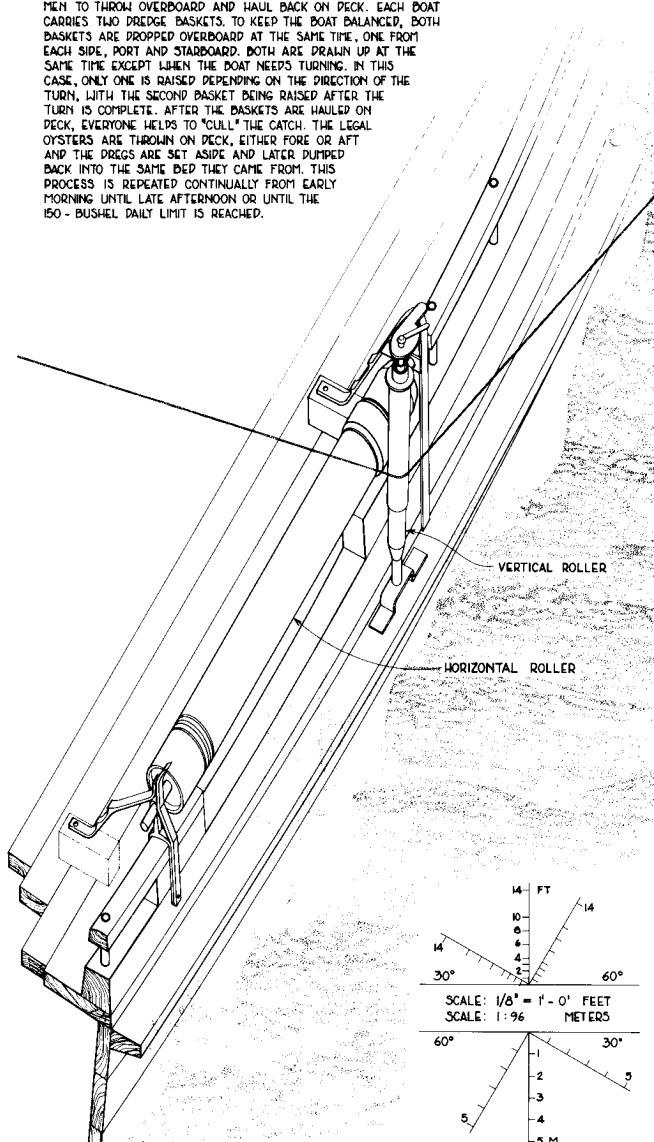

1/2" DIAMETER CABLE MADE OF HEMP AND STEEL

VERTICAL ROLLER

HORIZONTAL ROLLER

THE DREDGE BASKETS ARE RAISED AND LOWERED BY A CABLE WHICH IS EXTENDED AS FAR AS SIX TIMES THE WATER'S DEPTH. THE CABLE IS ATTACHED TO THE "WINNER", A POWERED BY A GASOLINE ENGINE. (SEE SHEET 7 OF 8) THIS ENGINE, USUALLY A REDUBIL AUTOMOBILE ENGINE, TURNS A SET OF AXLES ON THE WINDERS, THUS WINDING AND UNWINDING THE CABLE TO RAISE AND LOWER THE BASKETS. THE WINDER EQUIPMENT IS LOCATED ROUGHLY AMIDSHIPS, LEAVING DECK SPACE FORE AND AFT FOR THE CATCH AND FOR SORTING THE CATCH OR "CULLING". IN ORDER TO FACILITATE THE WINDING PROCESS, AND TO PREVENT DAMAGE TO THE BOAT'S RAILS FROM THE WEIGHT AND PULL OF THE BASKETS, A SET OF METAL ROLLERS, ONE HORIZONTAL AND ONE VERTICAL, IS LOCATED ON EACH SIDE, AMIDSHIPS. ON AVERAGE, IN ADDITION TO THE CAPTAIN, IT TAKES SIX MEN TO EFFECTIVELY RUN A DREDGING OPERATION. TWO MEN FOR EACH OF THE BASKETS, ONE TO RUN THE WINDER AND THE SIXTH TO RELIEVE THE OTHERS FROM TIME TO TIME.

TO PREVENT OVER HARVESTING OF THE OYSTER BEDS, THE SKIPJACKS, AND OTHER VESSELS IN THE DREDGING FLEET CAN ONLY DREDGE FOR OYSTERS UNDER SAIL. THIS CONSERVATION MEASURE PRECLUDES AN ENGINE IN THE BOAT AND HAS LED TO THE USE OF AN ENGINE-POWERED PUSHBOAT, SLUNG OFF DAVITS AT THE STERN. PUSHBOATS CAN LEGALLY BE USED TO ASSIST DREDGEBOATS IN AND OUT OF HARBOR AND IN MAKING THE TRIP TO AND FROM THE DREDGING GROUNDS. THE E. C. COLLIER'S PUSHBOAT IS STILL IN PRIVATE HANDS IN 1989. IT WAS BUILT BY SATT AND DAVE MCQUAY OF WITTMAN, MARYLAND AROUND 1970. NOTHING IS KNOWN ABOUT THE ORIGINAL PUSHBOAT.

SOURCES:
 DECAST, ROBERT, THE OYSTERMEN OF THE CHESAPEAKE, INTERNATIONAL MARINE PUBLISHING CO., CAUDEN, MAINE, 1970.

HEDEEN, ROBERT A., THE OYSTER: THE LIFE AND LORE OF THE CELEBRATED BIVALVE, TIDEWATER PUBLISHERS, CENTERVILLE, MARYLAND, 1986.

PEPPER, RANDALL S., WATERMAN, JOHN HOPKINS UNIVERSITY PRESS, BALTIMORE, MARYLAND, 1979.

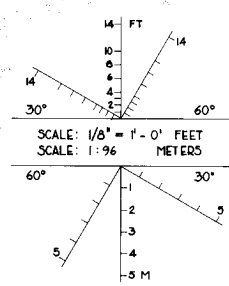

DELINEATED BY ALAN S. MICHAELS - LAURA E. SALADANO - 1989		TWO SAIL BATEAU (SKIPJACK) E. C. COLLIER (1910)		SHEET 8 OF 8	
E. C. COLLIER RECORDING PROJECT HISTORIC AMERICAN ENGINEERING RECORD UNITED BY NATIONAL PARK SERVICE		MILL STREET AT NAVY POINT TALBOT COUNTY		HISTORIC AMERICAN ENGINEERING RECORD MD-77	
ST. MICHAELS		MARYLAND		IF REPRODUCED PLEASE CREDIT: HISTORIC AMERICAN ENGINEERING RECORD, NATIONAL PARK SERVICE, NAME OF DELINEATOR, DATE OF THE DRAWING	

Fig. 4.7.40

CARVINGS and DECORATION

Fig. 4.7.41

Schooner *JOHN W. ATKINS*

Documentation

While delineation of these carving features is bold and legible, the appearance is schematic or simplified. Whether the drawing is schematic or not, there are no notes to inform the user.

Nothing on the drawing indicates whether this decoration is carved into the cutwater, merely painted on it, or both carved and painted.

Do the black, gray, and white tones represent any specific colors? Were the original colors actually black, white and gray? Or are the tones merely artist's interpretation liberally exercised? There is no verbal indication.

Some of these questions may be answered by a photograph or a description in the written data, but there is little effort involved in adding verbal notes of this sort to a drawing in order to make it more immediately useful.

From Auxiliary Schooner JOWN W. ATKINS, HAMMS No. 8-43 (no sheet number)

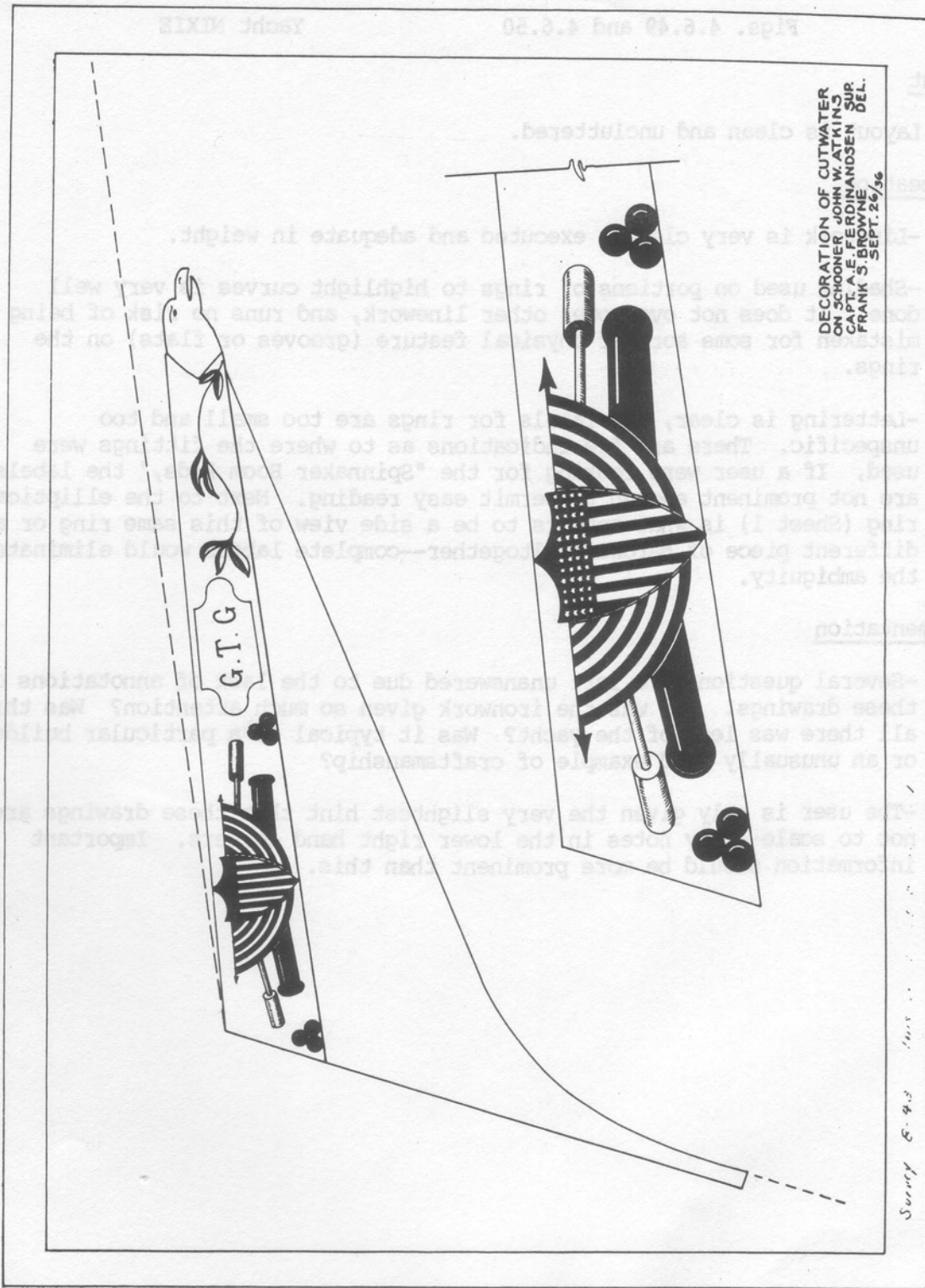

Fig. 4.7.41

MAPS

Fig. 4.7.42

Ship *BALCLUTHA*

Ships were designed to travel, and unlike land-based structures, they were not intended to have permanent berths. In cases of preserved or sunken vessels associated with museums or historic sites, location maps are recommended on title sheets. Other maps to consider include vessel voyages and ports, whether in a regional area (bay or river system), an ocean, or around the world.

Layout

This sheet was designed to present basic verbal, locational, and pictorial information about this vessel. Titles, text, maps and views are neatly distributed in a symmetrical pattern. A series of maps takes the reader from a view of the World's oceans down to her immediate vicinity.

Delineation

Line weights for lettering, maps and illustration views complement each other. The lettering for the title adds to the graphic success of the sheet.

Documentation

The text addresses the vessel's history as a ship that traveled the globe and its current location as a museum ship. Additionally, the sheet serves as a table of contents for the drawing set.

Labels are prominent and very clear.

SHIP BALCLUTHA

Built in 1886 by Charles Connell and Co.

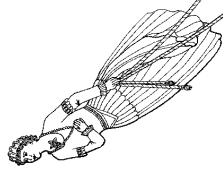

STAR OF ALASKA

During her 13 years in general trade under the "Red Duster," (British merchant ship flag) BALCLUTHA rounded Cape Horn 17 times and traveled to all but a few of the great seaports of the world. In 1899 she was sold to an American citizen, Herbert Charles Oswald, and within two months she had been sold again to L. D. Spencer, a Hawaiian citizen, and was granted provisional Hawaiian registry. She began working in the Pacific Coast lumber trade, and was sold again in 1900 to Pacific Colonial Ship Co., a San Francisco corporation acting for J. J. Moore and Co., a major broker in the export lumber trade. According to Maritime Historian John Lyman, BALCLUTHA was the last vessel to sail under the Hawaiian flag, she received United States registry by an act of Congress in 1901.

BALCLUTHA began her career in the Alaskan salmon trade in 1902 when she was chartered by the Alaska Packers' Association (A.P.A.). In 1904, while bound north for the season, she was wrecked off Chirikof Island, Alaska. Badly holed and heeled over on an offshore reef, her captain assumed she was unsalvageable. William Mann, superintendent of the A.P.A. Kotlik cannery on Kodiak Island, felt she could be saved, however, and bought the ship for \$500. After temporary repairs she returned to the San Francisco Bay in 1905 and received extensive new bottom plating at the United Engineering Works shipyard in Alameda. In 1906 her name was changed by act of Congress to STAR OF ALASKA. In 1911 her poop deck was extended forward 68'-8" to increase her berthing accommodations. She sailed to Alaska every spring, and returned each fall to the A.P.A. shipyard in Alameda, until 1929, when she and the STAR OF HOLLAND were the last A.P.A. vessels ever to go north under sail. In 1930 she was towed to Alaska and back — the final voyage of a "salmon packer".

STAR OF ALASKA was purchased in 1933 by Frank G. "Tex" Kissinger, an ex-carnival man from Los Angeles, and renamed PACIFIC QUEEN in 1934. After many failed plans to make money with the vessel, Kissinger finally had success by

PACIFIC QUEEN

exhibiting her as a "pirate ship" at Pier 43 during the 1939 World's Fair in San Francisco. Unfortunately, she had to give up her berth when World War II broke out, and narrowly escaped being confiscated by the government and converted into a coal barge. After the war Kissinger and his wife Rose were unable to match their pre-war success. In 1952 Frank Kissinger died of a heart attack while securing the vessel against winter storms.

In 1953 at the suggestion of Karl Kortum (founder of the San Francisco Maritime Museum and presently the Chief Curator of the San Francisco Maritime National Historical Park), a committee from the Maritime Museum, consisting of Captain William Mills, Kortum, Max Lembeck, Scott Newhall, Michael Ryan, and Captain T. C. Conwell offered to buy the vessel from Rose Kissinger. After a difficult year of negotiations, Mrs. Kissinger was persuaded to sell the ship for \$20,000 plus a \$5,000 mortgage. Karl Kortum drew up restoration specifications and work began in 1954. Labor union leaders came forward and offered to help and every Saturday for a year, 30 to 40 skilled volunteers worked on the ship. Captain Conwell successfully solicited services from shipyards and other maritime industries to support the volunteer labor force.

Filled with relevant exhibits, the restored vessel, renamed BALCLUTHA, was opened to the public as a museum ship at Pier 43 in San Francisco in July, 1955 and was an immediate success. In 1978, BALCLUTHA became the property of the National Park Service when the San Francisco Maritime Museum and the California Maritime State Park became part of the Golden Gate National Recreation Area (GGNRA). In 1986, the museum and the historic ships were separated from GGNRA to become the San Francisco Maritime National Historical Park. Apart from trips to the shipyard for routine maintenance, BALCLUTHA remained at Pier 43 until April 28, 1988 when she was moved to Hyde Street Pier to join the other historic ships in the collection of the newly designated maritime park.

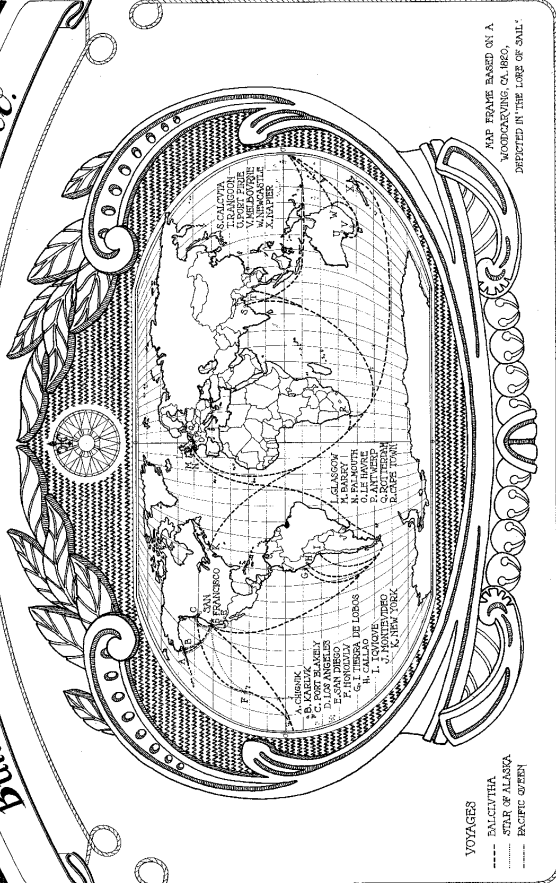

TABLE OF CONTENTS

91	FRAMING DETAILS	Sheet 50
92	FRAMING & MIZENMAST DETAILS	51
93	DECK STRUCTURE DETAILS	52
94	GROUND TACKLE	53
95	CASTINGS	54
96	BILGE PUMPS	55
97	PATENT STEERING GEAR	56
98	COMPASSES & BINOCLES	57
99	DOORS AND PORT-HOLES	58
100	HATCHES	59
101	SALON SKYLIGHT	60
102	SKYLIGHT AND GLASS PANEL	61
103	SKYLIGHT AFTER GLASS PANEL	62
104	SKYLIGHT END & SIDE PANEL	63
105	SKYLIGHT ROOF PANEL	64
106	SLEDDING DOOR	65
107	LOOK UP DECK SKYLIGHT DETAILS	66
108	SAILERS PACKERS ASSOC.	67
109	BERTH ACCOMMODATION PLAN	68
110		69

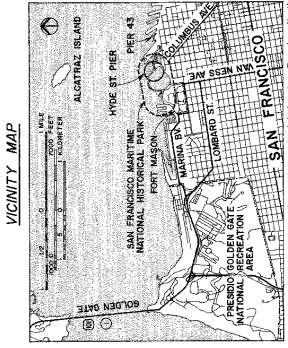

TABLE OF CONTENTS

1	TITLE SHEET	Sheet 1
2	GENERAL NOTES	2
3	DECK PLANS (REDUCED)	3
4	INDOOR PROFILE (REDUCED)	4
5	INDOOR PROFILE (REDUCED)	5
6	BODY PLAN	6
7	SHEER & HALF-BREADTH PLANS	7-12
8-12	MAIN DECK PLAN	13-17
13-17	POOP DECK PLAN	18-22
18-22	FORECASTLE DECK PLAN	23-27
23-27	INDOOR PROFILE	28-30
28-30	INDOOR PROFILE	31
31	MIDSHIP SECTION	32-35
32-35	MIZENMAST	36
36	MAINMAST	37-41
37-41	SECTION AT FRAME 08	42-44
42-44	SECTION AT FRAME 08	45-48
45-48	FRAMING DETAILS - 886	49

Fig. 4.7.42

UNDERWATER NAUTICAL ARCHEOLOGY

Figs. 4.7.43 and 4.6.45

U.S.S. ARIZONA

The following two sheets are included to show how an underwater resource might be recorded for HAER. The immense size of this ship compared to other vessels shown in this section is notable, as is the limited visibility under which it was recorded.

Layout

The views are laid out without crowding.

Associated blurbs and keys are legibly lettered and placed next to the views they address.

The long graphic scale permits easy scaling of any dimension from the drawings.

Delineation

Note how darkened barbettes and other deck openings read in the 1984 plan as opposed to the 1986 plan. The darkened portions visually indicate the ship's condition a little better

Documentation

These views illustrate in detail the "as is" condition of the ship at the time of documentation. Very small details such as rivets were omitted as too small to show, and much larger remains were measured and depicted.

The different dates for the plans in Fig. 4.7.67 should be more prominently lettered in order to make the distinction more immediately clear to the reader. The 1984 date should be prominently displayed in labels for both views in Fig. 4.7.68 so that no date parallelism between the plans and profiles is assumed on account of the similar sheet layout.

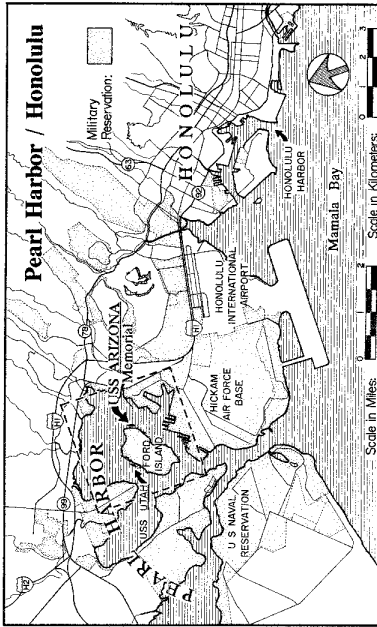
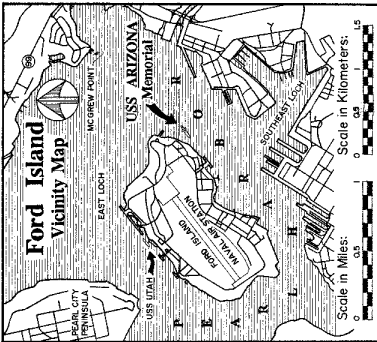
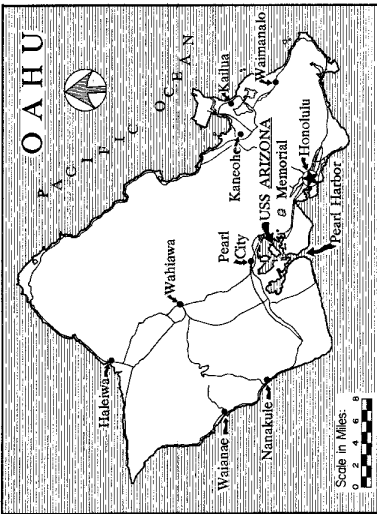

DOCUMENTING THE USS ARIZONA

The submerged battleship USS ARIZONA was documented in 1984 using basic, low cost and labor intensive techniques. The use of photogrammetry was not possible due to six foot visibility, the shallow water and the high site relier. The basic measuring tools were stinging, clothespins, and measuring tape.

No. 18 gage nylon string was laid over the ship to establish straight lines which were marked every ten feet with numbered plastic clips to form a kind of "cat's cradle" over the site. The line measurements of the cradle were then plotted on paper and served as the base for taking measurements by triangulation - relating known points on the marked lines to target features on the wreck. Thousands of separate measurements were taken during the four weeks in the field. Each evening, data collected during the day were copied onto a master set of drawings. Each morning, mylar overlays were made of small sections of the drawings and affixed to the diver's slates, along with a list of required measurements.

To confirm accuracy of critical points along the gunnel and other features of the badly deformed deck, a local survey crew shot targets with an infrared theodolite, or electronic distance-measuring (EDM) instrument. Divers held the reflective mirrors of the EDM motionless on top of a PVC (polyvinyl chloride) pole, as the bottom of the pole was held in place on the lecture to be mapped. Because of the poor visibility, it was necessary to hand-measure over curves as if they were on a two dimensional plane. The ship was divided into ten sections of sixty feet by the vertical strings from the cradle, creating twenty individual "frames" to be drawn in two dimensions. The illustrators later corrected each frame to compensate for the two-dimensional depiction of the ship's curved hull.

VIEW FROM OFF PORT BOW

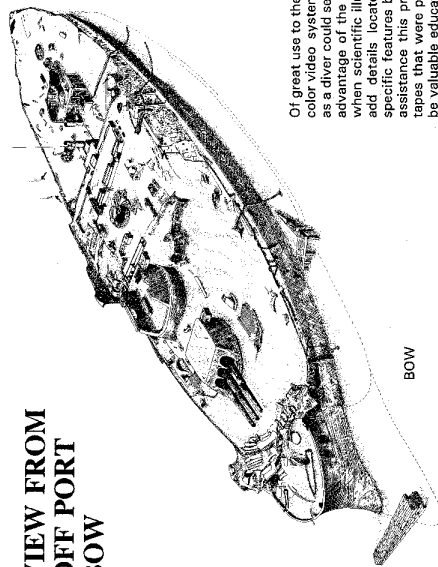

STERN

VIEW FROM OFF STARBOARD STERN

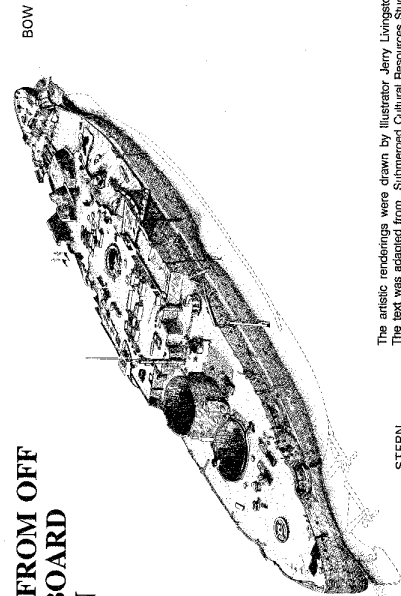

BOW

STERN

Of great use to the team was a low-cost, self-contained color video system which could record at least as much as a diver could see in the limited visibility. The greatest advantage of the video became apparent in the office when scientific illustrator Jerry Livingston was able to add details located between known map points on specific features by consulting the tapes. Besides the assistance this provided in the mapping process, the tapes that were produced during the survey proved to be valuable educational tools.

The artistic renderings were drawn by illustrator Jerry Livingston. The text was adapted from Submerged Cultural Resources Study, USS ARIZONA Memorial and Pearl Harbor National Historic Landmark, Daniel J. Lenihan, Editor, SCRUI, NPS.

Fig. 4.7.43

PLAN
Drawn in 1984

USS ARIZONA was documented during three weeks of intensive diving in 1984. Drawings were produced of a planimetric or "bird's eye" view of the ship (shown here) and of its port and starboard profiles (see sheet 4).

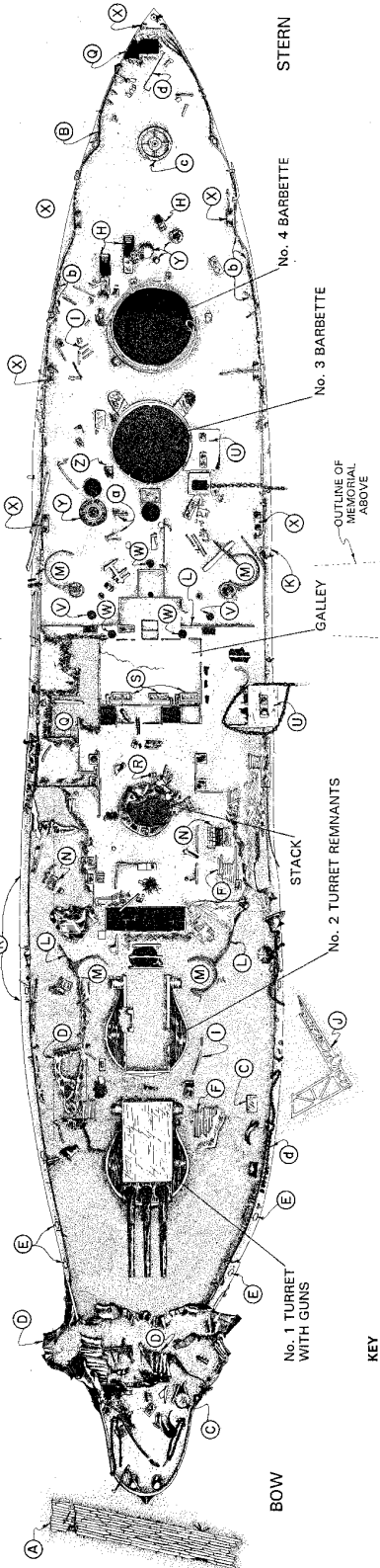

KEY

- A. CAMEL
- B. CABLE RUN
- C. STEEL PLATE
- D. MISC. SHEET METAL
- E. INSPECTION PORTS
- F. TEAK DECKING VISIBLE
- G. HATCH COVER
- H. OPEN HATCH WITH COVER
- I. MISC. PIPE
- J. FRAME
- K. TORPEDO BLISTER
- L. REMNANTS
- M. GUN TUB
- N. MEDICINE CABINET
- O. HATCH COVER
- P. PORT IN DECK
- Q. WINCH DRUM
- R. OVER BASE
- S. TABLE LEGS
- T. BITTS
- U. OLD MOORING BITTS
- V. VESSELS
- W. BOAT CRANE
- X. MAST TRIPOD LEG
- Y. VENTILATOR
- Z. HATCH (LEAKS OIL)
- a. RAIL STANCHION
- b. CATAPULT BASE
- c. RAIL STANCHION
- d. CHAIN

The final rendering was done by scientific illustrator Jerry Livingston, who also created two artist's perspectives of the vessel (see sheet 2). The drawings were finalized during the winter of 1984 and released by SCRU in 1985.

PLAN
Drawn in 1986

In 1986, Robert Sumrell, a ship modeler from Annapolis, Maryland, was contracted to use the SCRU drawings to build a model of the ARIZONA as she sat at the bottom of the wreck. He did not have enough information, and decided to survey the wrecked vessel and add objects on the deck that were overlooked in the earlier survey.

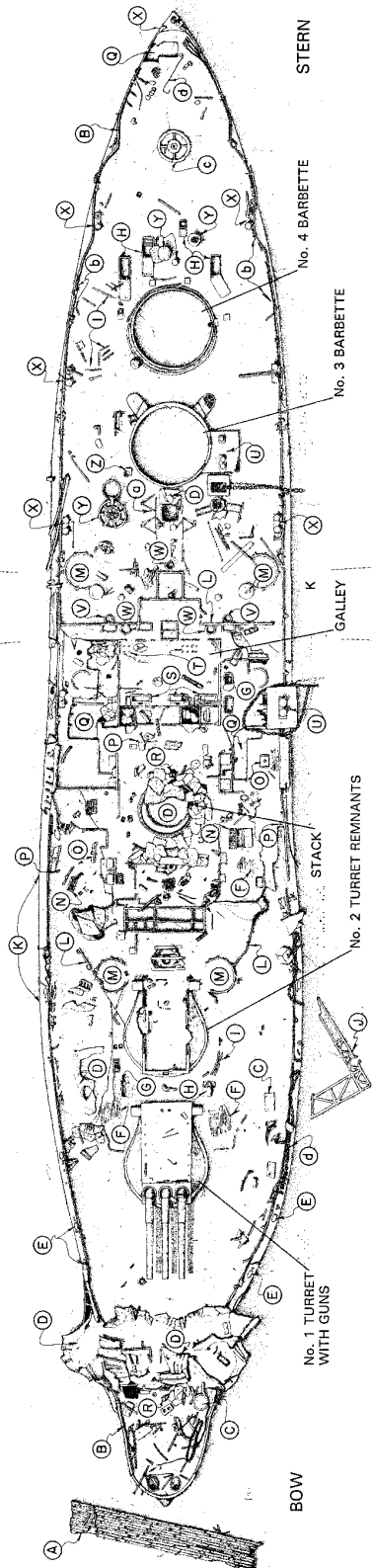

The 1986 plan view (shown above) was drawn by Larry Nordby, Chief of the Branch of Cultural Research, National Park Service, Southwest Regional Office. At the time of the ARIZONA survey, a biofouling/corrosion study was conducted on the metal components and the amount of biofouling on the ship's metal structural elements.

Scale: 1:25" = 20'



Fig. 4.7.44

OUTBOARD PROFILES

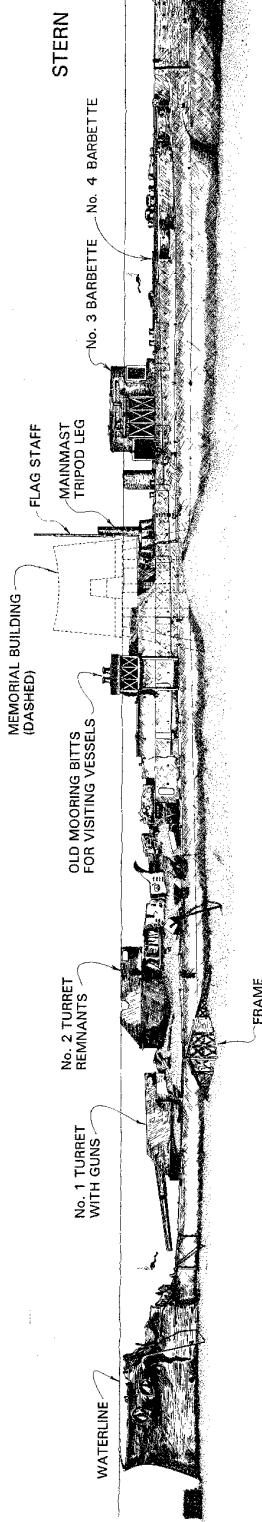

PORT PROFILE

Note:
 Because visibility in the water was only 6 feet, a diver one body length away from the ship could not see it. For this reason, the curves in the hull had to be hand measured as though they were on a two-dimensional plane. The ship was divided into ten 60 foot long sections using individual "frames" to be drawn in two dimensions. When the drawings of these frames were connected, they created a scaled drawing longer than the actual ship. To remedy this, it was necessary for the illustrators to correct each frame to compensate for the two-dimensional depiction of the ship's curved hull.

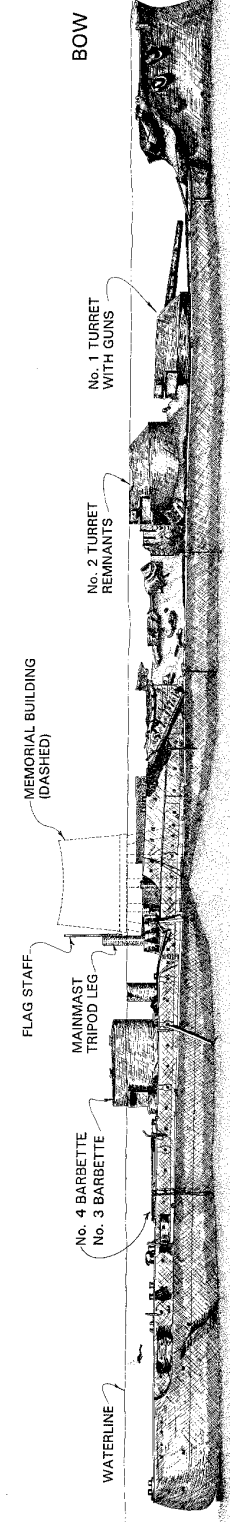

STARBOARD PROFILE

Scale: 1.25" = 20'

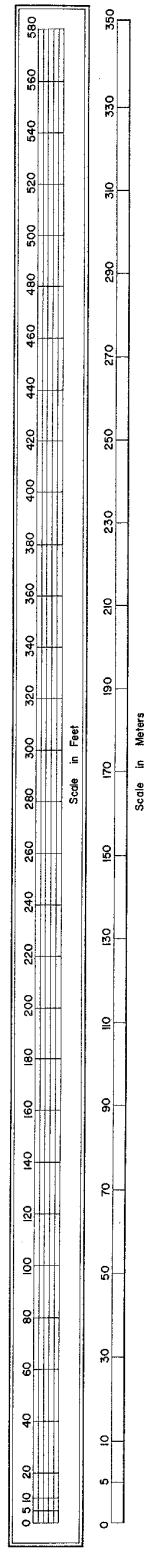

Fig. 4.7.45

JERRY L. LIVINGSTON after Forley Wetjans and Larry Nordby, 1984. Drawings were photographically reproduced and spliced onto the HAER sheet by Robbyn Jackson, 1992.

UNSS ARIZONA (BB-39)
 SUNKEN ON THE BATTLE OF HONOLULU
 HONOLULU COUNTY
 HISTORIC AMERICAN ENGINEERING RECORD
 H-13

SURFACE NAUTICAL ARCHEOLOGY

Fig. 4.7.46

Clipper Ship *SNOW SQUALL*

While "nautical archeology" usually connotes work on an underwater resource, there are potential archeological projects for vessels on land or buried in the earth. The remains of the *Snow Squall* are the only surviving remnants of an American clipper ship. This documentation was prepared as a basis for the conservation and interpretation of the ship.

Layout

The arrangement of views, graphic scale and notes is tight but legible

Delineation

Linework is clear and strong; no lines "dropped out" in reproduction because they were too light.

Lettering is neat and legible.

Documentation

The notes cover the conditions under which the vessel's lines were lifted, the method used, and important qualifications for the lines drawings.

Stations, frames, water lines and buttock lines are almost all labeled. No "zero" water line is indicated, nor is any account given as to how specific water line heights were derived. Water lines above 8'-6" are not dimensioned, nor is the abbreviation "WL" ever spelled out as "water line"

Labels for the rabbet and garboard require arrows so those unfamiliar with ship construction are not confused about which lines denote these features.

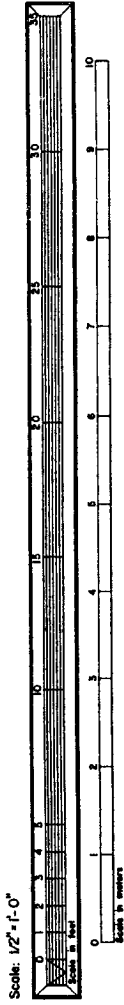
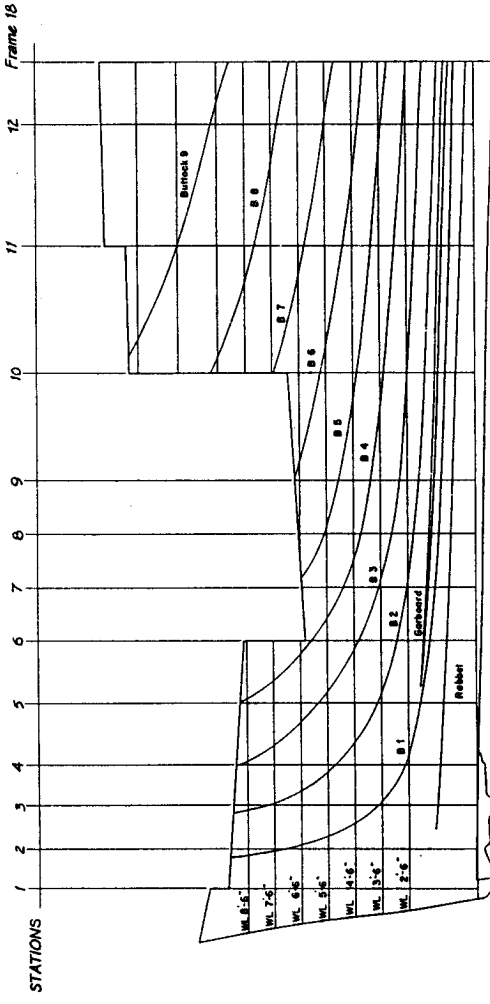
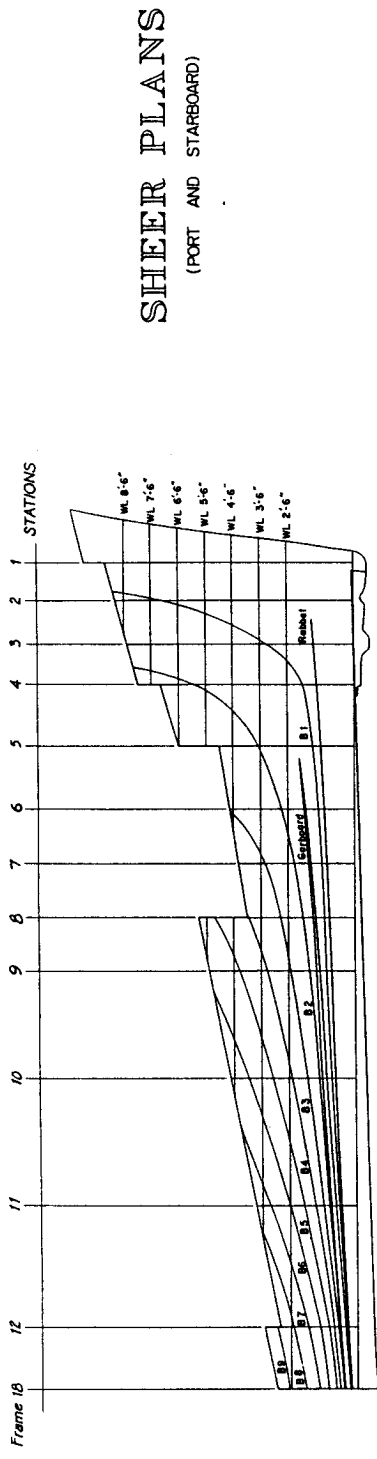

- Notes:
- SNOW SQUALL's lines were taken with the bow fragment lying on a metal cotter and supported by blocking and jacks. The hull lies listing to port, with the keel running lower as it goes aft. Due to the condition of the hull and lack of symmetry, both port and starboard lines were lifted. Stations were established on the starboard side at intervals along the hull where it was deemed necessary and free of obstruction. The stations were then squared to the keel and marked with survey flagging tape. The starboard stations were transferred to the port side under the keel and marked. At station 1 points for measurement were established at intervals of one and a half feet, and subsequently transferred to each station using a water level. A ten-foot staff with measured one-foot increments was used to triangulate to these points, thus producing the data necessary for the drawings.
 - The lines depict the hull as it (1992) and are not an attempt to recreate "as built" lines.
 - All offsets are to the outside of the Muntz Metal sheathing or the outside of the hull plating.
 - Station 9 on the port side was found to be inaccessible due to blocking employed to support the hull.
 - While the accuracy of most field measurements is estimated to be 1/2", plots inevitably introduce larger errors due to the smaller scale of the drawings.

Fig. 4.7.46

SURFACE NAUTICAL ARCHEOLOGY

Fig. 4.7.47

Clipper Ship *SNOW SQUALL*

Layout

This sheet is very well composed. Note how the block of notes and the number key are positioned to relate to both views of the bow. The placement of the letter key implies it is an afterthought, however.

Delineation

Line work for the remains is very well executed. Pieces are outlined and rendering is done in lighter lines. The rendering is restrained and used to indicate significant evidence rather than "pretty up" the views. However, the reader is not told if the cross-graining in the section represents actual conditions or is merely pictorial in nature.

Notice how notes are placed and lettered in lettering smaller than that used for the key or drawing view. This hierarchy of sizes is very well developed and lends a sense of scale to the drawing.

Number tags are large and legible but unobtrusive.

Documentation

Views of the bow are carefully annotated with an extensive key.

The bases for the drawings are clearly described in the notes, as are tolerances for the drawings.

Scantlings are not provided; they would be very interesting historically. However, it may be argued that the reader could measure them from a drawing like this.

BELOW DECKS PLAN & SECTION

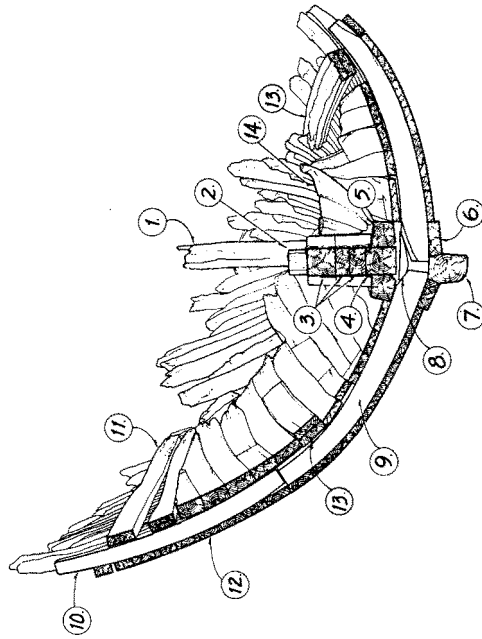

- 1. Stem
- 2. Mast Step
- 3. Rider Keelsons
- 4. Keelson
- 5. Sister Keelson
- 6. Garboard Strake
- 7. Keel
- 8. Filler
- 9. Futtock
- 10. Futtock
- 11. Ceiling Planking
- 12. Outer Planking
- 13. Bilge Stringers
- 14. Bracing

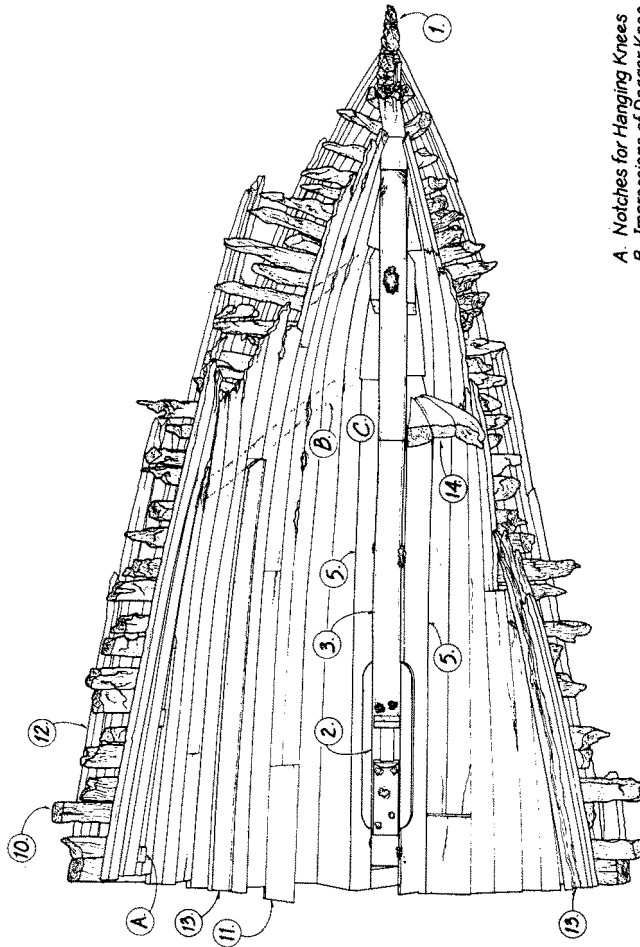

- A. Notches for Hanging Knees
- B. Impressions of Dagger Knee
- C. Scarf in Rider Keelson

Scale: 1/2" = 1'-0"

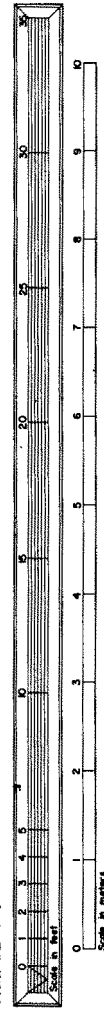

Notes:

Drawings in this set were developed from separately documented structural fragments, including SNOW SQUALL's lower bow section, two weendeck waterway assemblies, upper stem, breasthook and deck hook. The archeological team recovered these hull components during different field seasons, and the fragments were located in three separate areas of the Spring Point Museum's conservation facility at the time of their documentation. The recording team graphically combined the various components, relying in part on photographic evidence.

The Below Decks Plan was developed by taking outboard stations and transferring them inboard (1'-2"). Stations 4, 5, 6, 9, 10, 11 and the end cut were used to take offsets athwartship. Longitudinal measurements were established using a horizontal line running from the stem aft.

Fig. 4.7.47

SURFACE NAUTICAL ARCHEOLOGY

Fig. 4.7.48

Clipper Ship *SNOW SQUALL*

Layout

There are only three major components for this drawing. For the most part they are comfortably composed on the sheet, however, the view label ("axonometric") seems a little crowded toward the drawing border.

Delineation

This drawing is very carefully and finely delineated. Foreground assemblies are carefully outlined to make them read forward of background details.

Rendering is admirably restrained so as not to compete with or obscure the shapes of structural components.

Documentation

The note makes very clear how this drawing was derived.

This view is very useful since it assembles pieces that are stored in different locations. Even if the pieces were assembled so that photography were possible, the view excludes extraneous information that would be captured in a photograph.

As an axonometric drawing, an axonometric scale should be given by which a reader may know how the axes were oriented, and what scales were used on each axis. As it is, no scale at all is provided.

A key identifying parts would be instructive.

Was any attempt made to document fastening patterns? The drawing shows none, and the note does not address the issue one way or another.

AXONOMETRIC

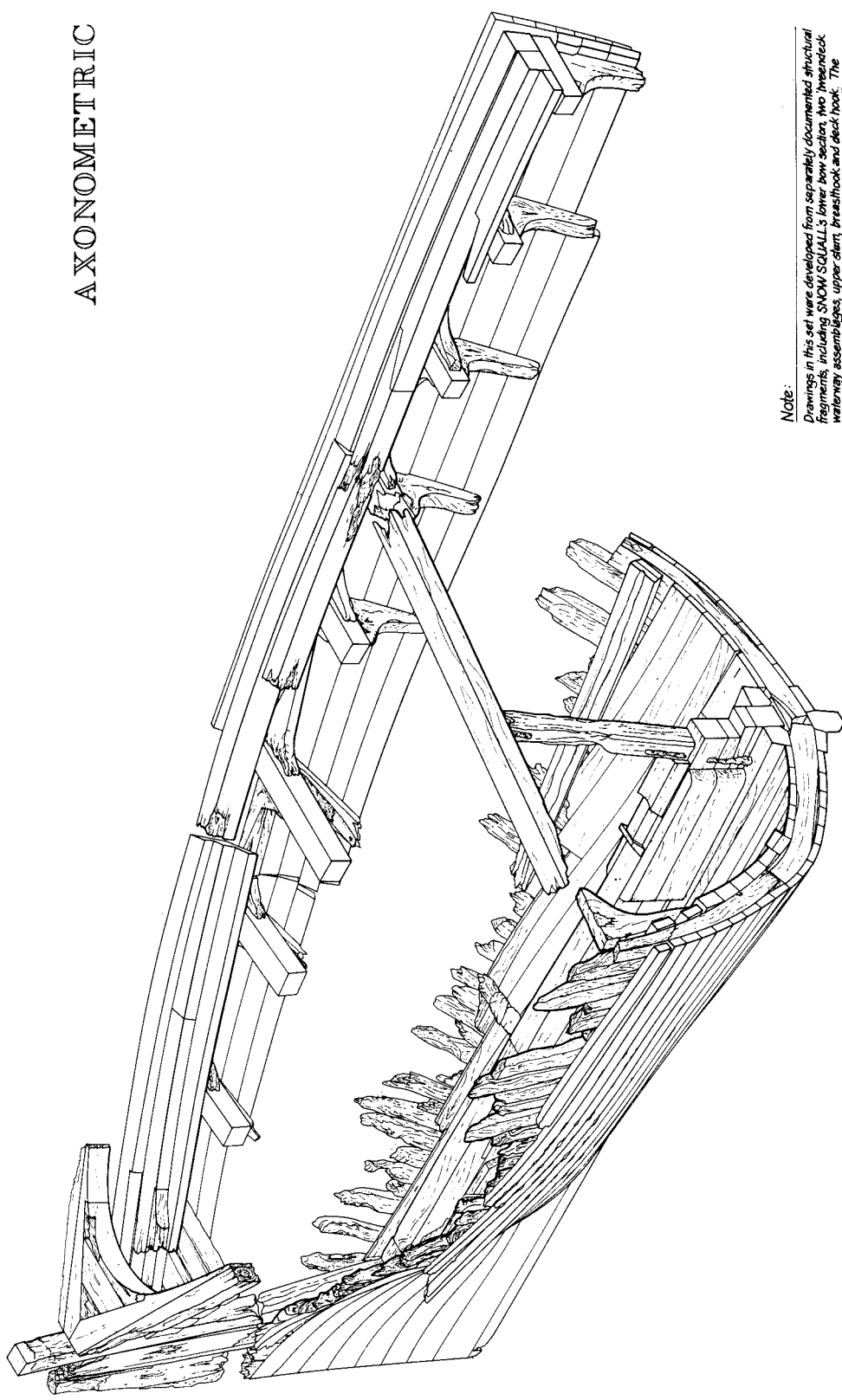

Note:
 Drawings in this set were developed from separately documented structural fragments, including SNOW SQUALL's lower bow section, two innerdeck waterway assemblies, upper stem, breasthook and deck hook. The archeological team recovered these hull components during different field seasons, and the fragments were located in three separate areas of the Spring Point Museum's conservation facility at the time of their documentation. The recording team graphically combined the various components, relying in part on photographic evidence.

Fig. 4.7.48

REFERENCES and RESOURCES

The following reference books are cited primarily for technical use in terminology and drawing rather than historical research, although they may certainly augment historical studies. (The HAER history guidelines should be consulted for standard historical references.) Though many of these books are long out of print, there are none like them currently in print for understanding what are now historic vessels. Many of these volumes turn up in the technical sections of used book stores. Annotations are provided to most books' contents.

This list is not exhaustive. Suggestions for further inclusions are welcomed.

GENERAL GLOSSARIES AND DICTIONARIES

Baker, William A. *The Lore of Sail*. New York: 1983. ISBN 0-87196-221-7 This is a very thorough index to the technical terminology of sailing vessels, ideal for use by both amateurs and professionals. Unlike a dictionary, here you find it by the picture; you do not need to know a term before looking it up. Detailed line drawings of all parts of vessels are given, and parts are numbered and labeled for identification. This book is widely available, but may be ordered from:

Facts on File Publications
460 Park Avenue South
New York, NY 10016

Kerchove, Rene de. *International Maritime Dictionary: An Encyclopedic Dictionary of Useful Terms and Phrases, Together with Equivalents in French and German*. New York: Van Nostrand Reinhold Company, 1961. Standard work.

McEwen, W.A., and A.H. Lewis. *Encyclopedia of Nautical Knowledge*. Cambridge, Maryland: Cornell Maritime Press, 1953.

Tryckare, Tre. *The Lore of the Ship*. New York: Crescent Books, 1972. Similar in approach to *The Lore of Sail*; includes mechanical propulsion and warships.

WOODEN SHIPBUILDING

Adkins, Jan. *Wooden Ship: The Building of a Wooden Sailing Vessel in 1870*. Boston: Houghton Mifflin Company, 1978.

Desmond, Charles. *Wooden Shipbuilding*. New York: Vestal Press, 1984.

Estep, H. Cole. *How Wooden Ships Are Built: A practical Treatise on Modern American Wooden Ship Construction with a Supplement on Laying Off Wooden Vessels*. New York: W.W. Norton and Company, Inc., 1983. Reprint of 1918 edition.

IRON AND STEEL SHIPBUILDING

Baker, Elijah III, B.S. *Introduction to Steel Shipbuilding*. New York: McGraw- Hill Book Company, 1943. Long out of print, but useful because it includes both rivetted and welded construction for merchant vessels. A very detailed glossary is included. Lines and offsets are covered, as well as weight and displacement calculations, stability, trim, tonnage, and other subjects.

Lloyd's Register of British and Foreign Shipping. London: Wyman & Sons, 1869. Contains detailed descriptions, tables, and engravings setting out the rules and regulations for design, construction, maintenance, and surveying of wooden and metal vessels.

Swanson, W.E. *Modern Shipfitter's Handbook*. New York: Cornell Maritime Press, 1941. Instructions in layout, molding, assembly, and erection of welded ships. Some riveting.

Thearle, Samuel J.P. *The Modern Practice of Shipbuilding in Iron and Steel*. London: William Collins, Sons, & Co., Ltd., 1891. Vol. I, Text. Vol. II, Plates. Second edition, revised and enlarged. Authoritative guide to late 19th-century practice, includes detailed engravings and descriptions. Out of print, but may be available in some maritime museum libraries or large public libraries.

RIGGING

Biddlecombe, Capt. George, R.N. *The Art of Rigging, Containing an Explanation of Terms and*

4.8.2 References and Resources

Phrases and the Progressive Method of Rigging Expressly Adapted for Sailing Ships. Salem, Massachusetts: Marine Research Society, 1925. Extensive tables, diagrams, glossary.

Kipping, Robert. *Sails and Sailmaking.* London, England: The Technical Press, 1936. 196 pp. illustrated.

Lever, Darcy. *The Young Sea Officer's Sheet Anchor, or a Key to the Leading of Rigging and to Practical Seamanship.* London: 1819. 2nd ed. Reflects British practice in the early 19th century, but covers rigging and sails in detail, including various ship handling instructions, and a brief glossary. Reproduced in 1963 by the photolithographic process from the second edition by:

Edward W. Sweetman Co.
Publisher
One Broadway
New York, NY

Underhill, Harold J. *Masting and Rigging the Clipper Ship and Ocean Carrier: with Authentic Plans, Working Drawings and Details of the Nineteenth and Twentieth Century Sailing Ship.* Glasgow: Brown, Son, & Ferguson, Ltd., 1979. ISBN 0-85174-173-8 This is an extremely complete guide to the principles and engineering behind rigging, as well as a key to terminology. A British work, so some terms may be different from American usage. Very thoroughly illustrated. If not available locally, it can be ordered from:

Brown, Son & Ferguson, Ltd.
Nautical Publishers
52 to 58 Darnley Street
Glasgow, G41 2SG
Scotland

WOOD IDENTIFICATION

Constantine, Albert J., Jr. *Know Your Woods: A Complete Guide to Trees, Woods, and Veneers.* New York: Charles Scribners' Sons, 1987. Compiled for the use of cabinetmakers, this volume covers the subject of woods from a number of angles. It contains photos of wood samples from several dozen species worldwide. The photos are all black and white, which may hinder its usefulness for the less experienced.

Edlin, Herbert L. *What Wood is That? A Manual of Wood Identification.* London: Thames and Hudson Limited, 1969. This work discusses and contains

actual wood samples for 40 different species worldwide. Pine, oak, Douglas fir, birch, beech, ash, walnut, cedar, elm, and maple are included. Numerous characteristics for each species are discussed and compared. Fifth printing in June 1981 by:

The Viking Press
625 Madison Avenue
New York, NY 10022

MACHINERY AND EQUIPMENT

International Library of Technology. Vol. 9B, *Marine Boilers, Refrigeration.* Scranton, Pennsylvania: International Textbook Company, 1907. Extensive illustrated chapters on marine boilers, details, boiler accessories, and propulsion as well as other topics.

International Correspondence Schools Reference Library. Vol. 170, *Marine Engines, Marine Pumps.* Scranton, Pennsylvania: International Textbook Company, 1907. Extensive treatment of steam reciprocating engines for screw-propulsion and paddlewheel vessels. Also treats valve gears, auxiliaries, and steam turbines. Excellent illustrations.

Seward, Herbert Lee. *Marine Engineering.* Vol. I. New York: The Society of Naval Architects and Marine Engineers, 1942. Eleventh printing 1968. Chapters on steam turbines, boilers, reduction gears, propellers and shafting.

__. *Marine Engineering.* Vol. II. New York: The Society of Naval Architects and Marine Engineers, 1944. Eleventh printing 1968. Chapters on auxiliaries: condensers, pumps, blowers, generators, piping.

Sterling, Frank Ward, ed. *Marine Engineers' Handbook.* New York: McGraw-Hill Book Company, Inc., 1920. Highly technical, but very useful for understanding construction, terminology, and materials for boilers and machinery aboard ship.

NAVAL ARCHITECTURE

Gillmer, Thomas C., and Bruce Johnson. *Introduction to Naval Architecture.* Annapolis, Maryland: Naval Institute Press, 1982. A textbook for Naval Systems Engineering Department at the United

States Naval Academy, it covers contemporary hydrostatics, hull and propulsion systems engineering.

NAUTICAL ARCHEOLOGY

Muckelroy, Keith. *Handbooks in Nautical Archeology*. No. 1, *Discovering a Historic Wreck*. Greenwich, England: National Maritime Museum, 1981.

Robinson, Wendy S. *Handbooks in Nautical Archeology*. No. 2, *First Aid for Marine Finds*. Greenwich, England: National Maritime Museum, 1981.

PHOTOGRAMMETRY

Borchers, Perry E. *Photogrammetric Recording of Cultural Resources*. Washington, DC: Technical Preservation Services, Office of Archeology and Historic Preservation, National Park Service, U.S. Department of the Interior, 1977. Treats subject of terrestrial (as opposed to aerial) photogrammetry of archeological remains and buildings.

Karara, H.M., ed. *Handbook of Non-topographic Photogrammetry*. Falls Church, Virginia: American Society of Photogrammetry, 1979. Extensive presentation on photogrammetric cameras, equipment, and their non-aerial mapping applications. It even includes X-ray photogrammetry.

DRAFTING AND DOCUMENTATION

Baynes, Ken, and Francis Pugh. *The Art of the Engineer*. Woodstock, New York: The Overlook Press, 1981. Engineering drawings at their best. A beautiful graphic record of the evolution of engineering drawing and presentation of ships, railway equipment, automobiles, and airplanes.

International Library of Technology. Vol. 154, *Drawing, Ship Drafting, Projection, Developments*. Scranton, Pennsylvania: International Textbook Company, 1918. Contains a section on mechanical drawing and an extensive section on ship drafting directed toward production of working drawings of steel ships.

Jackson, Melvin H., ed. *The Historic American Merchant Marine Survey, Works Progress Administration, Federal Project No. 6*. Salem, New Hampshire: The Ayer Company, 1983. Seven bound volumes of selected full-size (19" x 24" and 19" x 34") reproductions of drawings and photographs from the HAMMS recording effort of the 1930s. Very expensive to acquire, but might be available at a maritime museum or major library.

Lipke, Paul, Peter Spectre, and Benjamin A.G. Fuller, eds. *Boats: A Manual for Their Documentation*. Nashville, Tenn.: American Association for State and Local History and the Museum Small Craft Association, 1993. Though not written for application to HAER documentation, this comprehensive and extremely useful text on the documentation of small craft contains much that is useful for large vessel documentation. Chapters covering field measurement techniques and drafting instructions are highly detailed and comprehensively illustrated. This volume is strongly recommended as a complement to *Guidelines for Recording Historic Ships*, especially for those who have never documented vessels before.

National Museum of American History. *Ship Plan List, Maritime Collection*. Washington, DC: Smithsonian Institution, 1984. Complete catalog of all drawings by Howard I. Chapelle, the Historic American Merchant Marine Survey, and several other collections. No illustrations however, except on covers. For a copy, send \$6.00 to the Division of Transportation, National Museum of American History, Smithsonian Institution, Washington, DC 20560.

Standards Committee, Maritime Heritage Task Force, National Trust for Historic Preservation. "Guidelines for Documentation". 1983. These draft guidelines (190 pages) include three case studies that may be of great use to documentation teams: Case Study II "The Mooseabec Lobster Boat," Case Study III "Taking Lines from a Vessel Too Large to be Leveled or Moved," and Case Study IV "Lines from a Model." Each case study is profusely illustrated and very "user-friendly." Copies may be obtained by writing the Maritime Division, National Trust for Historic Preservation, 1785 Massachusetts Avenue, N.W., Washington, DC 20036.

Trask, Edgar P. and John P. Comstock. *Ship Drafting*. (Scranton, Pennsylvania: International Textbook Company, 1939). Basic textbook instruction for drawing merchant ships of the mid-20th century. It

4.8.4 References and Resources

contains sections titled "Introduction to Ship Drafting," "Ship Drafting Parts 1-2," and "Drawings for Welded Ship Parts."

Warren, James Peter. "The Historic American Merchant Marine Survey." M.A. thesis, Cornell University, 1986. Developed from HAMMS official correspondence, records, and interviews with surviving principals of the Survey, this paper provides an excellent background for evaluating the work of HAMMS. The background history of the program is covered, and a critical examination is made of the program's organization, documentary approach, field methods, and records. For those interested in the development of guidelines for recording historic vessels, this work cites numerous pre-1930 published sources on which HAMMS workers relied, and HAMMS' "Specifications for the Measurement of Ships and Vessels" is included as an appendix.

APPENDICES

The following items cover material that HAER believes will see a lot of use in the field and at the drawing board in recording historic vessels.

Page

- 4.9.2 *The Secretary of the Interior's Standards for Architectural and Engineering Documentation*
- 4.9.3 Introduction to Admeasurement
- 4.9.15 Basic Geometric and Trigonometric Formulas
- 4.9.19 Some Basic Sailing Ship Rigs
- 4.9.25 Common Knots
- 4.9.27 How to Compute UTM Coordinates

**SECRETARY OF THE INTERIOR'S STANDARDS FOR
ARCHITECTURAL AND ENGINEERING
DOCUMENTATION**

Reproduced from the *Federal Register*, Vol. 48, No. 190
(Thursday, September 29, 1983), pp. 44370-44374.

A summary chart of the Standards is on p. 4.9.7.

revise chart to reflect no inventory format

INTRODUCTION TO ADMEASUREMENT

Admeasurement of a vessel is defined as the process of measuring a vessel's hull (and selected superstructure spaces) for purposes of official record and calculation of displacement and/or cargo carrying capacity. Because hulls are non-rectilinear shapes, rules have been established which specify what measurements should be made and where they are to be taken on a hull. These rules also establish measurements and formulas for approximating the volume of a hull and its cargo capacity. These rules have changed from time to time, so it is important to know what rules were in force at what times in order to interpret "register dimensions" found in official records. It is also important to realize that "register dimensions" bear *no* relationship to what is commonly meant by length, breadth, depth or tonnage. Laymen usually misunderstand such terms to mean overall length, width, height, and total weight of the vessel (as opposed to weight of cargo carried). Register dimensions also are not the same as "lofting dimensions" used for construction.

This section is not intended to be a comprehensive treatment of the subject of admeasurement, the history of its rules, or the rules currently in force. However, some insights will be given in these areas which should help vessel recorders understand what may be meant by terms such as "length" of a vessel, and point users to resources for further exploration of the topic if more information is desired. In the late 18th century, rules for measuring vessels and calculating displacement and tonnage in the United States varied widely, as they also did worldwide. Tonnage is always independent of displacement. The tonnage of a given vessel

doesn't change whether a vessel is loaded or not (unless the rules for calculating tonnage change), however, a loaded vessel will always have a higher displacement than the same vessel unloaded. Displacement is a direct function of a vessel's actual total weight. It is now usually a term employed only for naval vessels.

Determination of tonnage was important, because the cost of building a ship was usually based on it, as were port fees, or what a shipbreaker would pay an owner to scrap a vessel. Vessel owners are interested in lower tonnage to displacement ratios when shipbuilding costs, taxes, and port fees are keyed to tonnage figures. However, a high cargo capacity to displacement ratio is attractive, since this means more cargo can be transported for a given weight of vessel purchased and propelled through the water. In 1694, an act of Parliament in London, England, formalized the first simple tonnage rules which treated a vessel as if it were a box. The formula was modified in 1720 and in 1774 to take into account ships' very un-boxlike shape. The formula applied to both naval and civilian vessels. In 1800, British Tonnage still differed from American Custom House Tonnage, which differed further from Carpenter's Tonnage (a builder's formula also known as Builder's Old Measurement). In 1799, American Customs House tonnage was set down by Joshua Humphrey as follows:

Customs House Measurements of Ships & Other Vessels

To ascertain the tonnage of any Ship or Vessel the Surveyor or such other person as shall be appointed by the Collector of the District to measure the same, shall if the said Ship or Vessel be double decked take the length thereof from the fore part of the main stem to

the after part of the sternpost, above the upper deck [a straight line measurement, not made along the deck sweep], the breadth thereof at the broadest part above the main wales, half of which breadth shall be accounted the depth of such Vessel, & shall then deduct from the length three fifths of the breadth--Multiply the remainder by the breadth & the product by the depth, & shall divide this last product by 95 [a deadrise factor added to allow for the angle of the bottom as opposed to a flat bottom]. [T]he quotient whereof shall be deemed the true contents or tonnage of such Ship or Vessel--and if such Ship or Vessel be single decked the said Surveyor or other person shall take the length & breadth as above directed in respect to a double decked Ship or Vessel Shall deduct from the said length three fifths of the breadth, and taking the depth from the underside of the deck plank to the ceilings in the hold, shall multiply & divide as aforesaid, and the quotient shall be deemed the tonnage of such Ship or Vessel. March 2nd, 1799.¹

Put mathematically,

$$\text{tonnage} = \frac{(L - 3/5B) \times (B \times 1/2B)}{95}$$

and $D = 1/2B$, where L = length, B = breadth, and D = depth as Humphrey specifies above.

British tonnage at one point was calculated by the formula

$$\text{tonnage} = \frac{L \times (B \times 1/2B)}{94}$$

where L = payable length of a vessel's keel (not length of deck), and B = vessel's extreme breadth. American Carpenter's tonnage differed from the British tonnage formula only in using a denominator of 95 instead of 94. The denominator of the

tonnage fraction is a quick way to distinguish between American and British tonnage figures.

Humphrey's formula held sway until British tonnage rules underwent major changes in 1836. At this point, American rules adopted some of the British changes. Builder's Old Measure saw use into the 1860s. Prior to 1864 in the United States, register tonnage was an estimate of a vessel's internal volume from which cargo capacity was deduced. Following changes to British rules in 1863, an act of Congress passed May 2, 1864, revised the tonnage formula to more closely determine a ship's cargo capacity. Under the new rules, a given ship might have as little as one-half the tonnage calculated under the old formula. The definition of a ton itself underwent many changes. Seawater weighs approximately one ton for every 35 cubic feet. However, a cargo ton was a unit of volume as opposed to weight. Originally it was equivalent to 60 cubic feet, derived from the volume of a "tunne" or cask of Bordeaux wine. Later, a ton of 100 cubic feet was adopted.

Dimensions themselves were recorded differently at various times. Prior to the latter half of the 19th century, if a vessel's official length were given as "92.5", it may have meant she was 92'-5" long, not 92 and 5/10 feet. Later, vessels were measured in decimal feet, so that a figure reading "110.4" meant just that, 110 and 4/10 feet.

Recorders will encounter the terms "gross tonnage" and "net tonnage" in records and histories. Gross tonnage usually is the sum of a vessel's cargo space and the space devoted to living quarters and stowage for the crew. Net tonnage is the cargo capacity of the vessel alone. A vessel's draft is also different from her depth. Draft refers to the maximum dimension a vessel

extends below the water line (usually at the keel), which can change depending on how laden she is. Draft too has been subject to manipulation by formula. Depth, like tonnage, doesn't change whether a vessel is loaded or not. As a point of departure, "depth" (i.e., depth of hold) may be best thought of as the dimension between the underside of a vessel's main deck beams and the top of the ceilings at the point of the vessel's greatest breadth (which is not necessarily amidships). The official depth of hold may not correspond to this dimension if it is determined by a formula. (In other words, a vessel's actual depth of hold may not necessarily be 1/2 her breadth, as per Humphrey's formula above.) The rules for admeasuring a vessel for registration should never be confused with rules established by Lloyd's or other authorities for building or classing vessels. Builder's rules--using their own definitions of length, breadth, and depth--were established for engineering and insurance purposes and specified minimum allowable dimensions for structural members of a vessel.

The illustrations which follow should help clarify some of the interrelationships between various measurement terms for length, breadth, depth, and tonnage for historic vessels.

NOTES

¹ Joshua Humphrey, "Custom House Measurements of Ships & Other Vessels, March 2, 1799" AMs notebook by Humphrey, Drear Collection, Historical Society of Pennsylvania, Philadelphia.

of Federal Regulations, Title 46, parts 41-69 (which is a single volume). Part 69 covers admeasurement while parts 67-68 cover documentation (for registration). Questions regarding present admeasurement practices should be addressed to a local Marine Safety Office or Marine Inspection Office of the United States Coast Guard.

SUGGESTED READING

Bureau of Navigation, Department of Commerce.
Measurement of Vessels: Regulations Interpreting Laws Relating to Admeasurement of Vessels, Together with the Laws of the United States and the Suez Canal Regulations.
Washington, D.C.: Government Printing Office, 1915.

The Mariner's Mirror (quarterly British publication).
Articles on aspects of tonnage may be found in issues listed below;

American rules: Vol. 53, 260

Divisor of 94: Vol. 43, 343-343

Vol. 44, 161-164, 257-258

Vol. 45, 83-84

New and old rules: Vol. 47, 9-10

Shipbuilders' tonnage: Vol. 52, 336 ff.

Read, Samuel. "Investigations and Observations With Reference to the Laws for the Measurement of the Tonnage of Shipping," *Transactions of the Institution of Naval Architects*, Vol. 1, 1860: 121-127.

Ritchie, Joseph H. "Introduction to Lloyd's Revised Rules," *Transactions of the Institution of Naval Architects*, Vol. 4, 1863: 289-302.

The Transactions of the Institution of Naval Architects is a British publication. See also the *Society of Naval Architects and Marine Engineers: Transactions* (New York, N.Y.) for articles on American admeasurement and tonnage. For current regulations covering vessel registration and admeasurement, see Title 46 of the Code of Federal Regulations, Subchapter G, Documentation and Measurement of Vessels. Copies of these regulations may be purchased from the Superintendent of Documents, Government Printing Office, Washington, DC 20402. Ask for the Code

Adapted for illustrative purposes from CERTIF, HAMS No. 8-26, Sheets 2 and 3 of 3

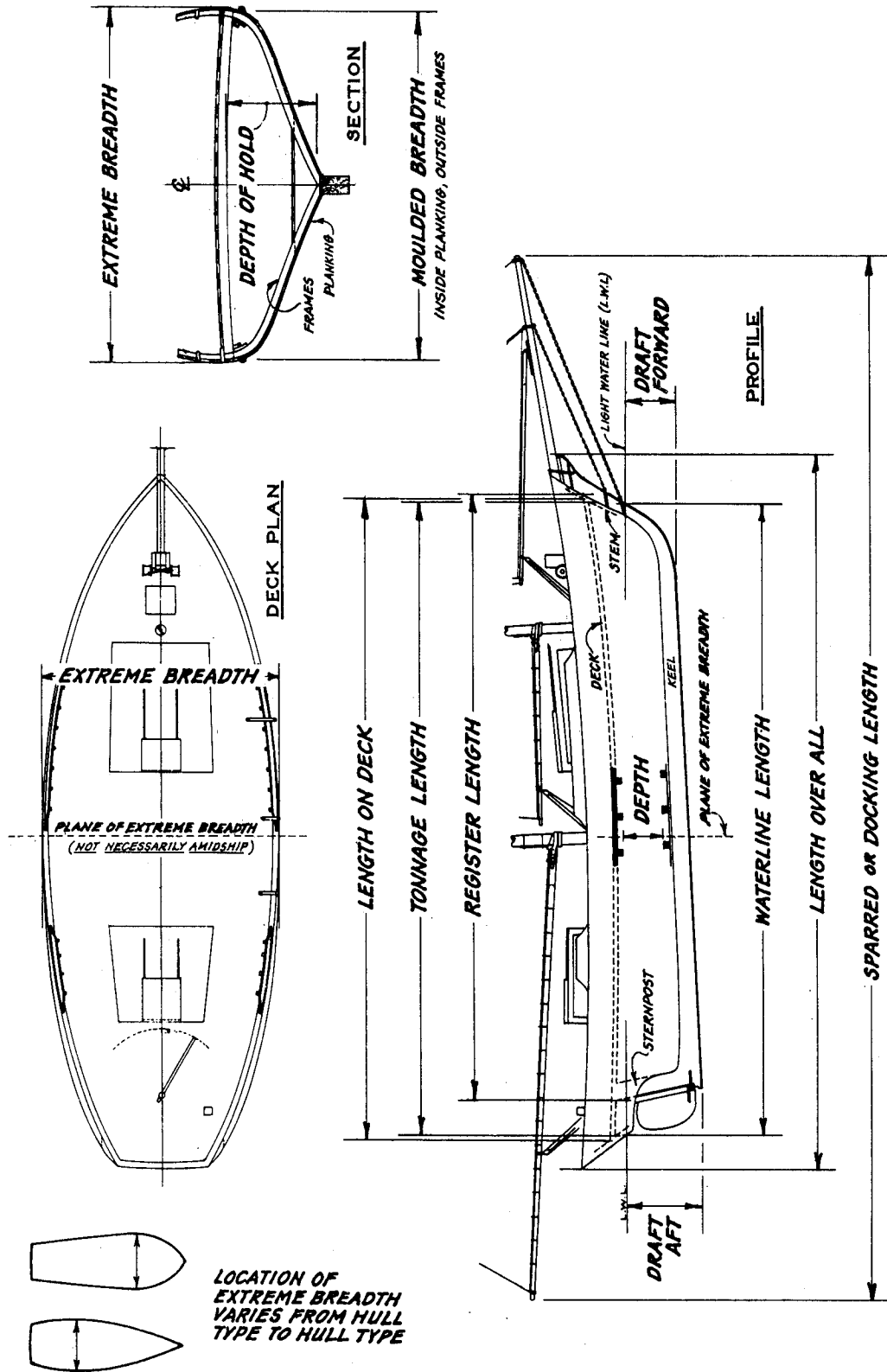

PRIMARY VESSEL MEASUREMENTS

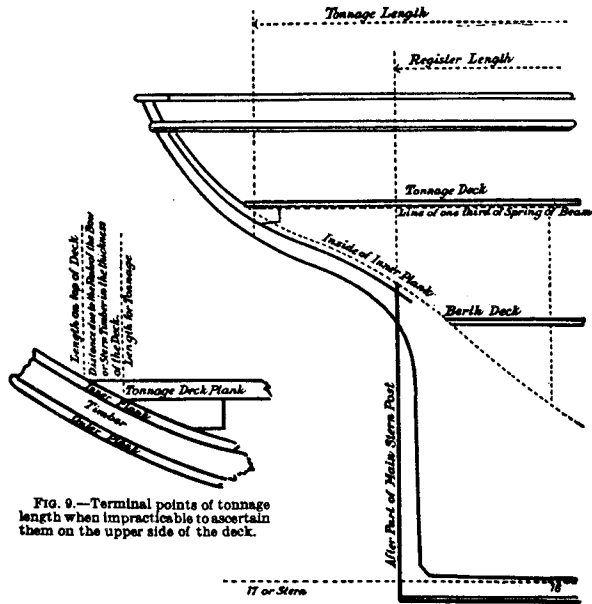

FIG. 9.—Terminal points of tonnage length when impracticable to ascertain them on the upper side of the deck.

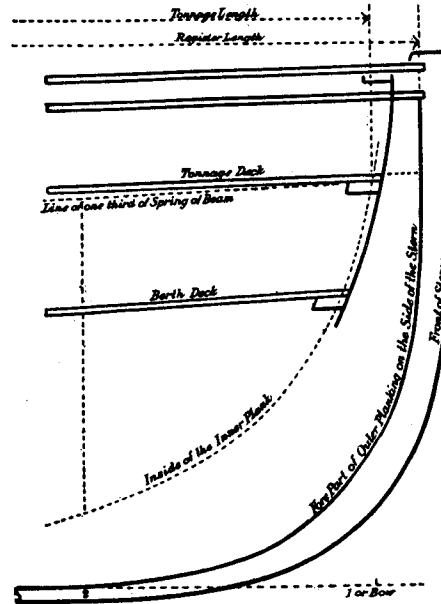

FIG. 1.—Register and tonnage lengths and tonnage deck of ordinary round-stern vessels.

Diagrams reproduced from Bureau of Navigation, Department of Commerce, *Measurement of Vessels: Regulations Interpreting Laws Relating to Admeasurement of Vessels, Together with the Laws of the United States and the Suez Canal Regulations*. Washington, D.C.: Government Printing Office, 1915; pp. 8-9.

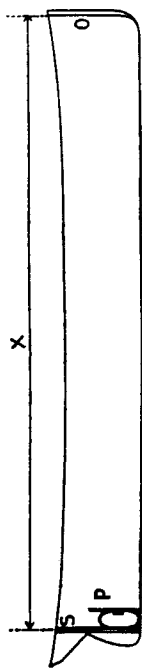

FIG. 2.—Register length of screw steamers with ordinary stern frame.

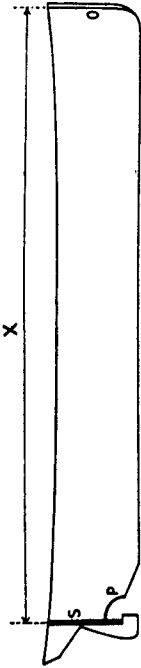

FIG. 3.—Register length of screw steamers with new-type stern frame.

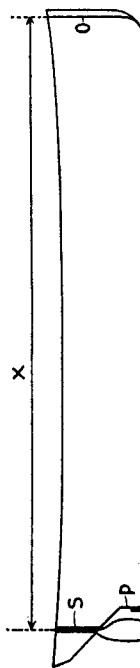

FIG. 4.—Register length of type of screw steamers on the Lakes.

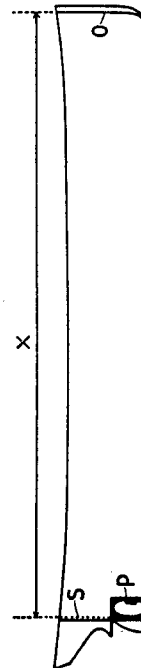

FIG. 5.—Register length of screw steamers of the "Great Northern" type.

In figs. 2, 3, 4, and 5, X represents register length; O represents outer planking on stem; P represents propeller post; S represents after part of stern frame or main sternpost.

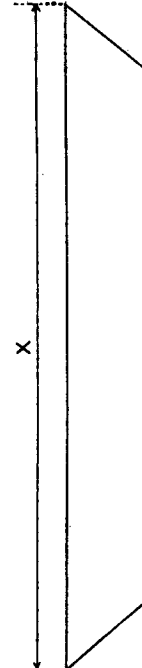
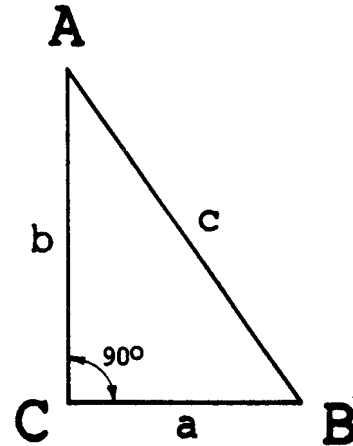

FIG. 6.—X, register length of scows or barges with neither stem, sternpost, nor rudderpost.

BASIC TRIGONOMETRIC and GEOMETRIC FORMULAS

RIGHT TRIANGLES

FIND	GIVEN	SOLUTION	FIND	GIVEN	SOLUTION
A	ac	$\sin A = \frac{a}{c}$	a	Ab	$b (\tan A)$
	bc	$\cos A = \frac{b}{c}$		Ac	$c (\sin A)$
	ab	$\tan A = \frac{a}{b}$		bc	$\sqrt{c^2 - b^2}$
B	bc	$\sin B = \frac{b}{c}$	b	La	$\frac{a}{\tan A}$
	ac	$\cos B = \frac{a}{c}$		Ac	$c (\cos A)$
	ab	$\tan B = \frac{b}{a}$		ac	$\sqrt{c^2 - a^2}$
C			c	La	$\frac{a}{\sin A}$
				Ab	$\frac{b}{\cos A}$
				ab	$\sqrt{a^2 + b^2}$



FUNCTIONS of a CIRCLE

A = area α = angle in degrees
 C = circumference l = length of arc

$$C = 2 \pi r = 6.2832r = 3.1416d$$

$$A_{\text{circle}} = \pi r^2 = 3.1416r^2 = 0.7854d^2$$

$$A_{\text{sector}} = r^2/2 = 0.008727 r^2$$

$$A_{\text{segment}} = 1/2 [rl - c(r - h)]$$

$$l = \frac{r \alpha \pi}{180} = 0.01745r \alpha = \frac{2A}{r}$$

$$c = 2 \sqrt{h(2r - h)} \quad r = \frac{c^2 + 4h^2}{8h}$$

$$h = r[1 - \cos(\alpha/2)] \quad \alpha = \frac{57.296 l}{r}$$

$$h = r - 1/2 \sqrt{4r^2 - c^2} \quad \alpha = 2[\sin^{-1} \frac{c}{2r}]$$

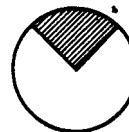

sector

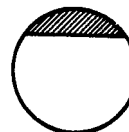

segment

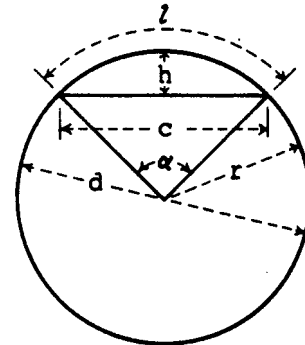

REGULAR POLYGON

A = area n = number of sides

$$\alpha = \frac{360}{n} \quad \beta = 180^\circ - \alpha$$

$$A = \frac{nsr}{2} = \frac{ns}{2} \sqrt{R^2 - \frac{s^2}{4}}$$

$$R = \sqrt{r^2 + \frac{s^2}{4}}$$

$$r = \sqrt{R^2 - \frac{s^2}{4}}$$

$$s = 2 \sqrt{R^2 - r^2}$$

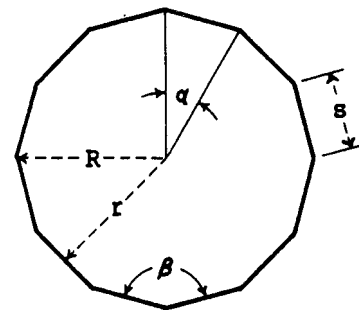

OBLIQUE TRIANGLES

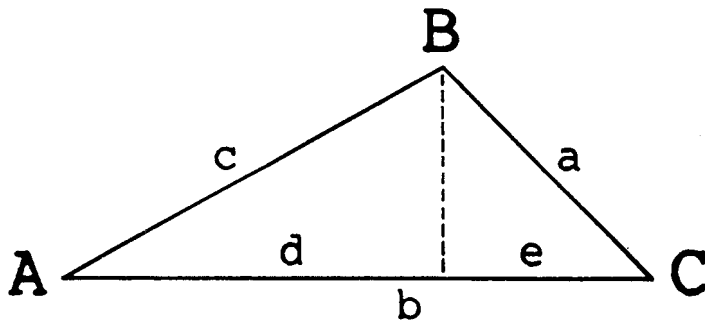

FIND	GIVEN	SOLUTION
AREA	abc	$\sqrt{s(s-a)(s-b)(s-c)}$
	Cab	$\frac{ab \sin C}{2}$
s	abc	$\frac{a+b+c}{2}$
d	abcs	$\frac{(b^2+c^2-a^2)}{2b}$
e	abcs	$\frac{(a^2+b^2-c^2)}{2b}$
$\frac{(B+C)}{2}$	Abc	$90^\circ - \frac{A}{2}$
$\frac{(B-C)}{2}$		$\tan = \frac{(b-c) \tan(90 - A/2)}{(b+c)}$
$\frac{(A+C)}{2}$	Bac	$90^\circ - \frac{B}{2}$
$\frac{(A-C)}{2}$		$\tan = \frac{(a-c) \tan(90 - B/2)}{(a+c)}$
$\frac{(A+B)}{2}$	Cab	$90^\circ - \frac{C}{2}$
$\frac{(A-B)}{2}$		$\tan = \frac{(a-b) \tan(90 - C/2)}{(a+b)}$

FIND	GIVEN	SOLUTION
A	abcs	$\sin(A/2) = \sqrt{\frac{(s-b)(s-c)}{bc}}$
		$\cos(A/2) = \sqrt{\frac{s(s-a)}{bc}}$
		$\tan(A/2) = \sqrt{\frac{(s-b)(s-c)}{s(s-a)}}$
	Bab	$\sin A = \frac{a \sin B}{b}$
	Bac	$\frac{(A+C)}{2} + \frac{(A-C)}{2}$
	Cab	$\frac{(A+B)}{2} + \frac{(A-B)}{2}$
	Cac	$\sin A = \frac{a \sin C}{c}$
a	ABb	$\frac{b \sin A}{\sin B}$
	ABc	$\frac{c \sin A}{\sin(A+B)}$
	ACb	$\frac{b \sin A}{\sin(A+C)}$
	ACc	$\frac{c \sin A}{\sin C}$
	BCb	$\frac{b \sin(B+C)}{\sin B}$
	BCc	$\frac{c \sin(B+C)}{\sin C}$
	Abc	$\sqrt{b^2+c^2-2bc(\cos A)}$

FIND	GIVEN	SOLUTION
B	abcs	$\sin(B/2) = \sqrt{\frac{(s-a)(s-c)}{s(s-a)}}$
		$\cos(B/2) = \sqrt{\frac{s(s-b)}{ac}}$
		$\tan(B/2) = \sqrt{\frac{(s-a)(s-c)}{s(s-b)}}$
	Aab	$\sin A = \frac{b \sin A}{a}$
	Abc	$\frac{(B+C)}{2} + \frac{(B-C)}{2}$
	Cab	$\frac{(A+B)}{2} + \frac{(A-B)}{2}$
	Cac	$\sin B = \frac{b \sin C}{c}$
b	ABa	$\frac{a \sin B}{\sin A}$
	ABc	$\frac{c \sin B}{\sin(A+B)}$
	ACa	$\frac{a \sin(A+C)}{\sin A}$
	ACc	$\frac{c \sin(A+C)}{\sin C}$
	BCa	$\frac{a \sin B}{\sin(B+C)}$
	BCc	$\frac{c \sin B}{\sin C}$
	Bac	$\sqrt{a^2+c^2-2ac(\cos B)}$

FIND	GIVEN	SOLUTION
C	abcs	$\sin(C/2) = \sqrt{\frac{(s-a)(s-b)}{ab}}$
		$\cos(C/2) = \sqrt{\frac{s(s-c)}{ab}}$
		$\tan(C/2) = \sqrt{\frac{(s-a)(s-b)}{s(s-c)}}$
	Aac	$\sin C = \frac{c \sin A}{a}$
	Abc	$\frac{(B+C)}{2} + \frac{(B-C)}{2}$
	Bac	$\frac{(A+C)}{2} + \frac{(A-C)}{2}$
	Bbc	$\sin C = \frac{c \sin B}{b}$
c	ABa	$\frac{a \sin(A+B)}{\sin A}$
	ABb	$\frac{b \sin(A+B)}{\sin B}$
	ACa	$\frac{a \sin C}{\sin A}$
	ACb	$\frac{b \sin C}{\sin(A+C)}$
	BCa	$\frac{a \sin C}{\sin(B+C)}$
	BCb	$\frac{b \sin C}{\sin B}$
	Cab	$\sqrt{a^2+b^2-2ab(\cos C)}$

SOME BASIC SAILING SHIP RIGS

KEY to SAILS

- | | |
|-----------------------------|--------------------------------|
| 1. Flying Jib | 18. Lower mizzen-topsail |
| 2. Jib | 19. Upper fore-topsail |
| 3. Foretopmast-staysail | 20. Upper main-topsail |
| 4. Foresail | 21. Upper mizzen-topsail |
| 5. Mainsail | 22. Fore topgallant sail |
| 6. Cross-jacksail | 23. Main topgallant sail |
| 7. Spanker | 24. Mizzen topgallant sail |
| 8. Lugsail | 25. Fore royal |
| 9. Fore-topsail | 26. Main royal |
| 10. Main-topsail | 27. Mizzen royal |
| 11. Mizzen-topsail | 28. Main skysail |
| 12. Fore gaff-topsail | 29. Main topgallant staysail |
| 13. Main gaff-topsail | 30. Mizzen topgallant staysail |
| 14. Main topmast staysail | 31. Jib topsail |
| 15. Mizzen topmast staysail | 32. Fore-trysail |
| 16. Lower fore-topsail | 33. Staysail |
| 17. Lower main-topsail | 34. Gaff-topsail |
| | 35. Main royal staysail |

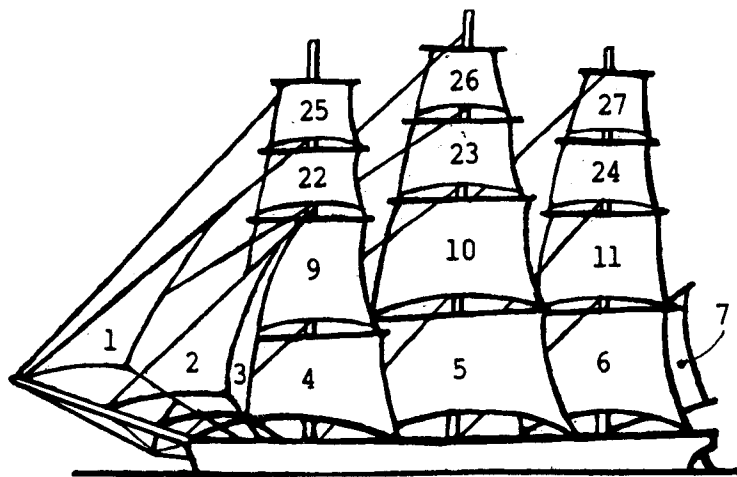

FULL-RIGGED SHIP

Nomenclature and illustrations of rigs based on Gardner D. Hiscox, M.E., *Mechanical Movements, Powers, and Devices*. New York: The Norman W. Henley Publishing Co., 1915; Sec. 10, Navigation and Roads, pp. 205-210.

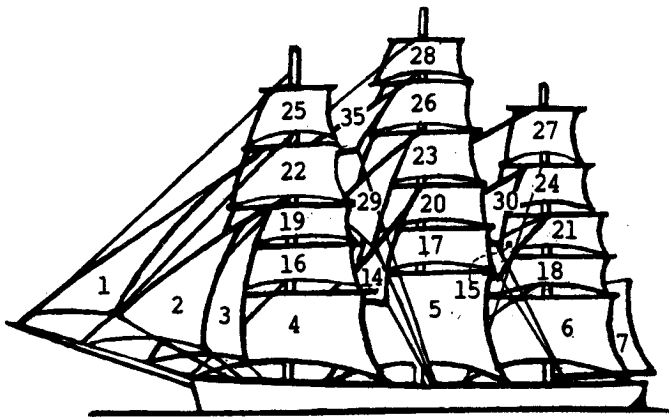

FULL-RIGGED SHIP

(Shows modifications adopted for full-rigged ships in the 1850s; some examples had 4 and 5 masts.)

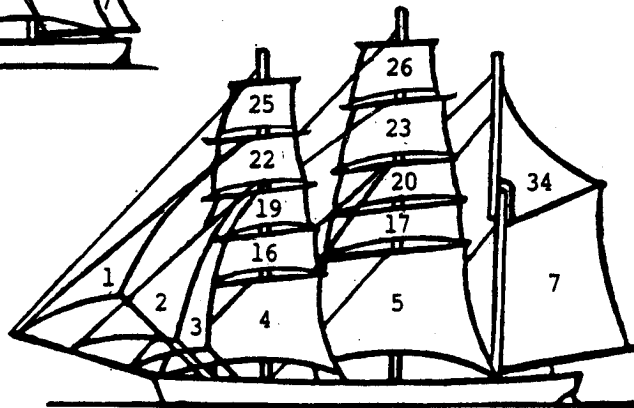

BARK

(Some examples had 4 and 5 masts)

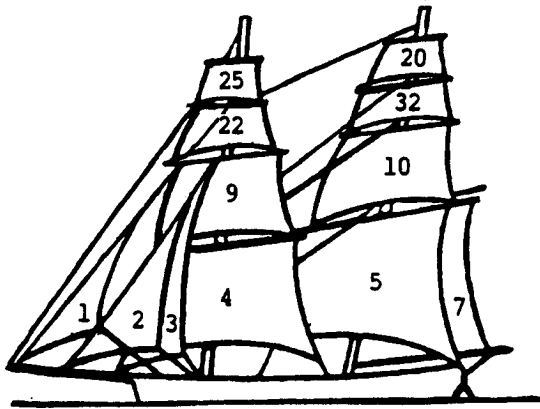

BRIG

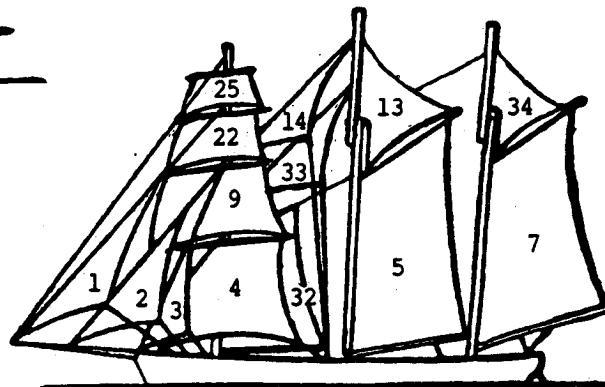

BARKENTINE

(Some examples had 4, 5 and 6 masts)

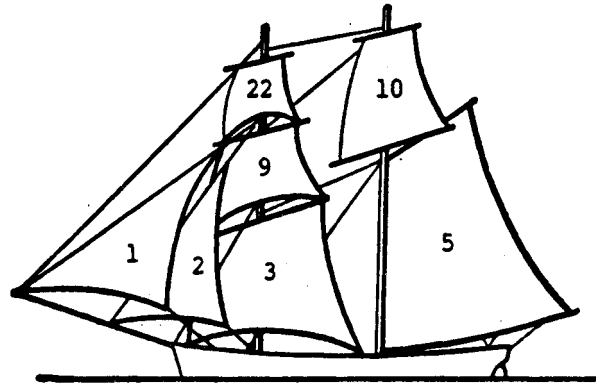

BRIGANTINE
(archaic)

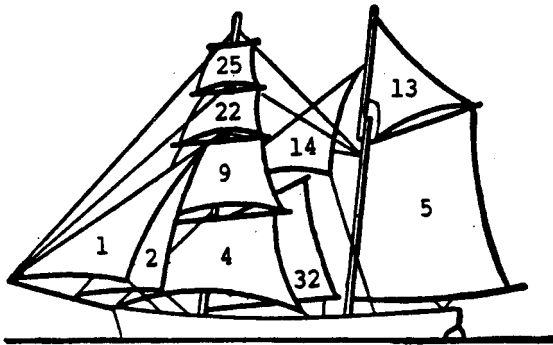

HERMAPHRODITE BRIG or HALF BRIG
(now known as BRIGANTINE)

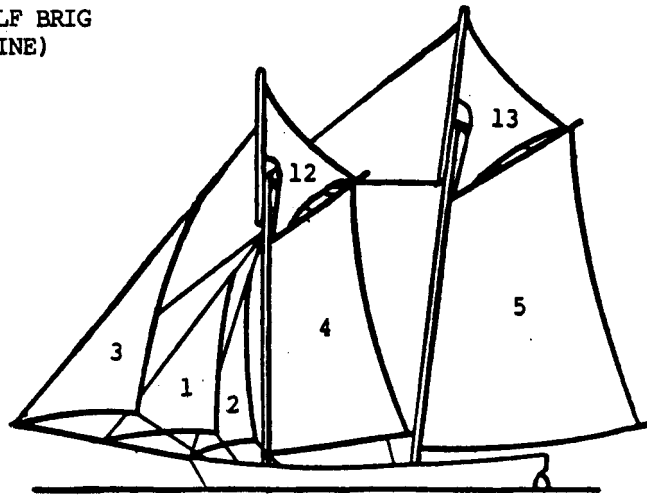

SCHOONER
(Some examples had 3, 4, 5, 6 and 7 masts)

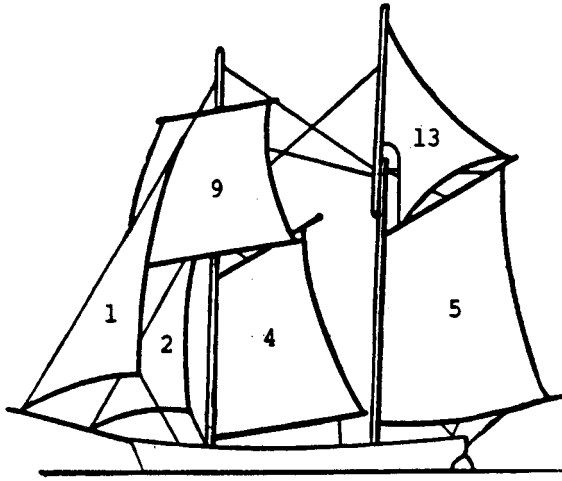

TOPSAIL SCHOONER

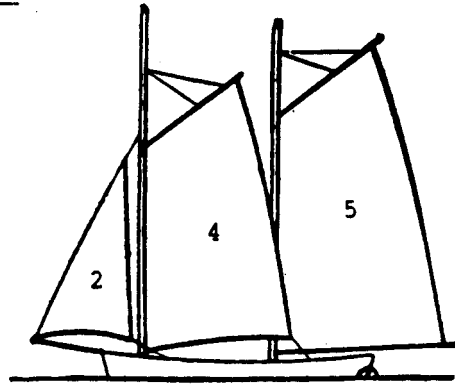

BALDHEADED SCHOONER

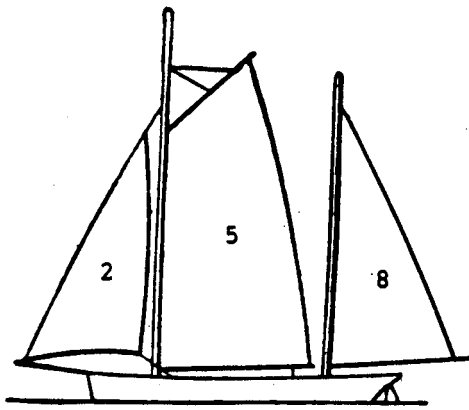

KETCH

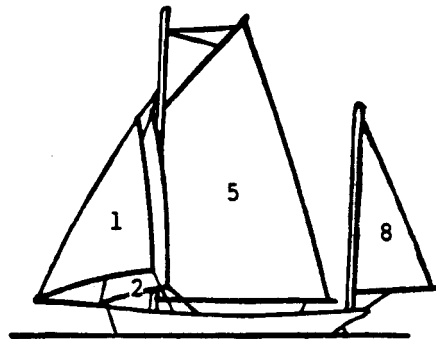

YAWL

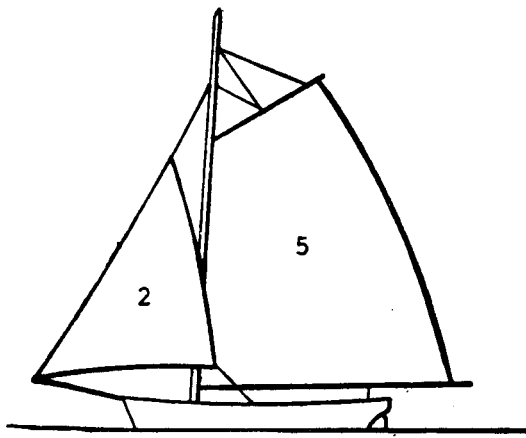

SLOOP

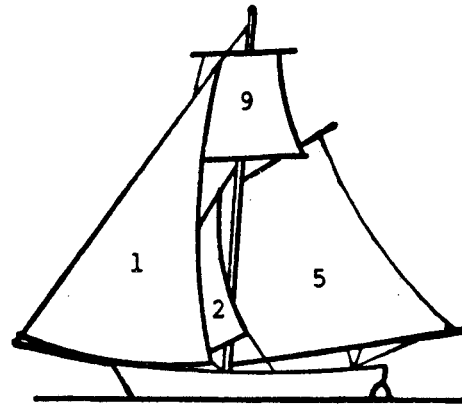

CUTTER

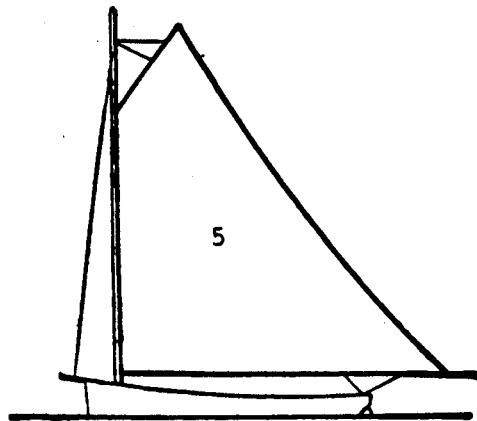

CAT-BOAT

COMMON KNOTS

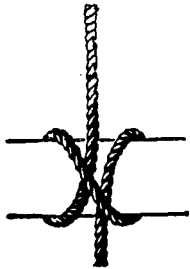

Clove Hitch



Half-hitch

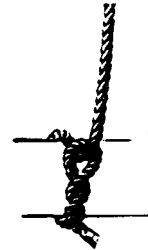

Timber Hitch



Square or Reef Knot



Stevedore Knot



Slip Knot



Flemish Loo



Bowline Knot



Carrick Bend

Nomenclature and illustrations of knots based on Gardner D. Hiscox, M.E., *Mechanical Movements, Powers, and Devices*. New York: The Norman W. Henley Publishing Co., 1915; Sec. 10, Navigation and Roads, pp. 205-210.



Overhand Knot



Figure Eight Knot



Boat Knot

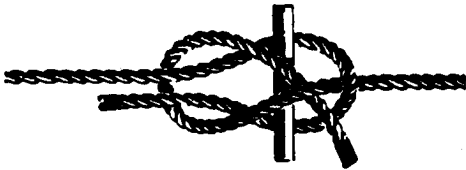

Sheet Bend and Toggle



Sheet Bend (Weaver's Knot)



Double Knot



Blackwall Tackle Hitch



Fisherman's Bend Hitch



Round Turn and Half Hitch

How to Compute

UTM GRID REFERENCE NUMBERS

The UTM (Universal Transverse Mercator) Grid System provides a simple and accurate method for recording the geographic location of historic sites. The UTM Grid System has a number of advantages over the Geographic Coordinate System (latitude/longitude), particularly in terms of speed and precision, and in the use of linear, metric units of measure, as opposed to the convoluted degrees, minutes and seconds of the geographic system. UTM involves no complex geometric constructions, and in its simplest application, requires only a straightedge, a “coordinate counter” (see p. 4.9.29), and a sharp hard-lead pencil as working tools. (The coordinate counter is a square frosted overlay with the appropriate scales to match the various United States Geological Survey, or USGS, map series.)

The UTM grid “reference” of a point may be found if the point to be located is on a USGS map that has blue UTM tick marks along its edges. Most USGS quadrangle maps published since 1950, and all published since 1959, have these ticks. If no USGS map with UTM ticks exists for your location, or the map has not been updated since 1950, this fact should be noted and extra attention given to the location map for your particular site or structure.

In the UTM system, the earth is divided into 60 “zones” running north and south, each 6 degrees wide, resembling the lunes in a beach ball. Each zone is numbered (most of the United States is in zones 10 through 19), beginning at the 180 degree meridian near the International Date Line. On a map, each zone is flattened, and a

square grid is superimposed upon it. The grid is marked off in meters, and any point in the zone may be referenced by citing its zone number, its distance from the central meridian of the zone (“easting”), and its distance north from the equator (“northing”). These three figures in the format below

zone number.easting.northing

make up a complete “UTM grid reference” for any point, and distinguishes it from any other point on the earth.

The simplest method for determining a UTM reference is base on drawing part of the UTM grid on the USGS quadrangle map by connecting corresponding blue tick marks, and measuring from the grid lines to the point. This requires the following:

- A. A flat work surface on which the map may be spread out in full.
- B. A straightedge (ordinary rulers may not be quite straight) long enough to reach completely across the map--generally 30 to 36 inches.
- C. A sharp, hard lead pencil. A 4x0 (0.18mm) drafting pen may also be used.
- D. A UTM coordinate counter.
Structures need only be identified by one reference; for linear routes, such as canals or railroads, references for the end points should be

given. For each point to be measured, follow these steps:

- A. Identify the point in question on the map.
- B. Draw a line from the top of the map to the bottom, connecting the UTM ticks directly west of the point, i.e. with the highest easting value less than that of the point. (Be sure the tick marks are marked with the same metric easting coordinate number.)
- C. Draw a line from the left to the right side of the map, connecting the grid ticks directly south of the point. (As with B, check that the two tick marks are marked with the same northing coordinate number.) This line will intersect the previous line somewhat to the southwest of the point to be located.
- D. Copy the zone number onto a worksheet; the number is in fine print in the lower left hand corner notes of the quadrangle map.
- E. Copy onto your worksheet the portions of the easting and northing values given at the map ticks through which the lines have been drawn.
- F. Locate the L-shaped scale on the coordinate counter which matches that of the map (usually 1:24,000 for 7.5 minute USGS quads). Align the counter so that
 1. The side of the scale that reads from right-to-left lies along the east-west line.

2. The side of the scale that reads from left-to-right passes directly up through the point.

Check the alignment to be sure it is precise.

- G. Read the coordinate counter scales, right-to-left for easting to the point where the vertical line you drew crosses the scale, and upward for northing to where the point to be located intersects the scale. Enter the measured values.
- H. Check the readings for plausibility — are all figures in the correct decimal place?
- I. Check the figures for accuracy by remeasuring.
- J. Be sure that the correct format is observed:

zone number.easting.northing
(2 digits).(6 digits).(7 digits)

On measured drawings, the UTM grid reference of a structure should be noted under the scale bars on the regional or local location map of the title sheet. On small scale maps, a pair of cross hairs with a circle centered on the referenced point should be shown to focus readers on the precise location.

UTM COORDINATE COUNTER

(mylar original can be requested from HAER or make photocopy on clear film)

UTM Coordinates can also be obtained using a GPS unit.

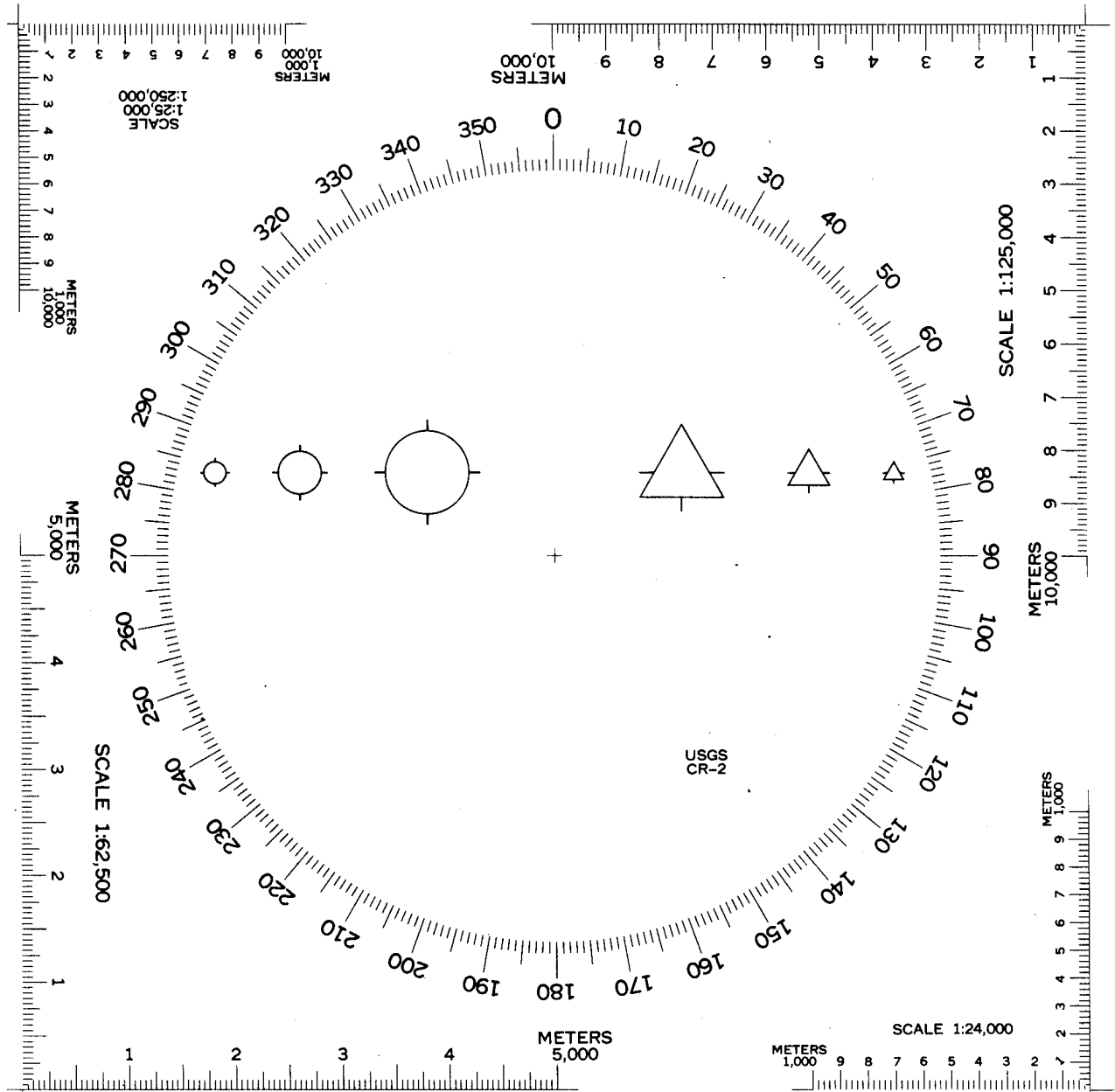

Section 5

FIELD REPORTS

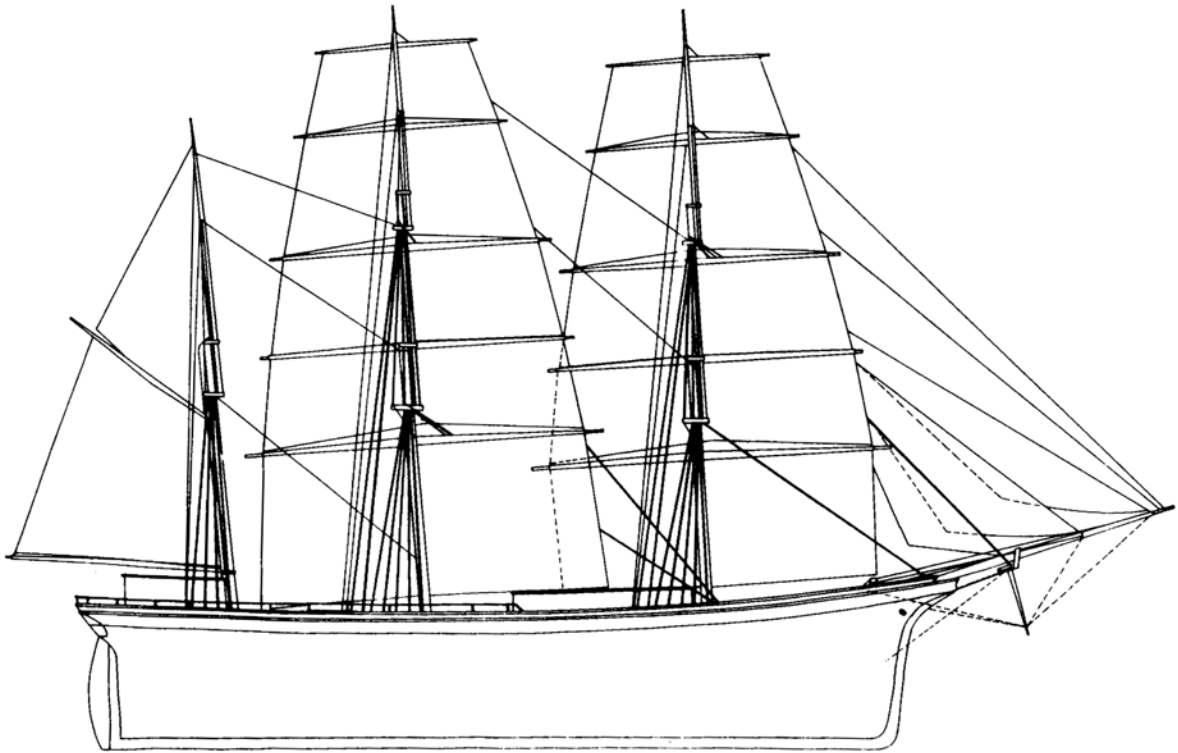

WHAT TO CONSIDER

General Remarks. The field report is intended to be an account and analysis of the recording team's methodologies and their execution during the project. It should cover the production of the historical report, formal photographs, and the measured drawings. The purpose of such a report is to give future users of your documentation an account of the context and parameters within which your work was performed, so they will know how much weight to give the various efforts expended in the project. The chief concept in preparing such a report is to document not only what you did, but also what you *didn't* do, especially when the actual course of your project took a direction different from what might normally or ideally have been expected, or when changes occurred in your planned goals, methods, and products. Such reports done for HAER projects should be included with the field records for transmittal to the Library of Congress.

There is no required minimum or maximum length for the field report. It should be to the point, but thoroughness should not be sacrificed for brevity. It is not necessary to go into the smallest details about everything, though detail should be supplied for any conditions requiring description or explanation.

Below is a suggested checklist to use when thinking through the writing of a field report.

Project Plan and Goals. How did your project come about? What were the goals of your project? Documentation for posterity? for use in building a replica? for personal interest? for training in documentation? for a museum? for HAER? How much time and money did you have to do the work? Who is paying for it (if anyone) and what is their interest in the project? What field conditions did you work under? Did

you have supervision or access to consulting services from professionals if the recording team is not staffed by professionals? What other resources or books did you use? Did you model your project on a previous similar, successful project?

Team Member Backgrounds. It is very helpful to know something about the background of each team member, advisor, consultant, etc. involved in the project. What knowledge, expertise, or usefulness did each bring to the project? While a project run by shipwrights and naval architects will have a high level of credibility automatically ascribed to it, this does not mean that a team staffed by astute amateurs cannot turn out excellent work. If a team's accomplishments are within its expertise, there is no reason not to trust its work, as far as it goes. The point is to define that expertise.

History. Did your project or project historian develop a research plan? What was it and how did it work out (or not)? What resources were available to you? Did some resources turn out to be unavailable, inconclusive, or too voluminous to handle? Why? Was something beyond your expertise? Was your work unduly limited by time or money? If so, what further work do you think should be done? What further records and resources might be consulted? (include locations, names). What "dead ends" did you find? Were any sources (owners, oral sources) uncooperative or exceptionally helpful and knowledgeable? What reasonable lines of inquiry were you unable to follow up on? Why? (Time, travel, expertise, or outside of project goals?)

Formal Photography. Who selected the views to be taken by the photographer(s)? What

criteria were being used? Were there any problems encountered, or conditions that prevented the making of certain photos? Were any special or unusual approaches tried? Why? How successful were they?

Measured Drawings. What methodologies and equipment had your project planned to use in its field work, and why? How were they applied? Did any aspects of your plan have to be modified? Did you discover useful shortcuts? How much time did your field work take, and was it within your estimates? What assumptions did you make, and what were the bases of your decisions to use them? How well did your field work plot out at the drawing board? Did you run into any significant problems (such as inability to get a space to "close"), and what did you do to resolve them? What tolerances did you work to in your dimensions? What views or types of information did you add or leave out of the drawing set, and why? Was the drawing set done with a certain slant, such as use for repairs or exhibits? How might the drawing set be different if it had been done only for straight documentation purposes? What things do the drawings omit, and why? Can a future researcher find information about the omissions in the field notes and photos or not? What technical expertise did the team have or call on for guidance? What models or reference books were used? Did you rely on pre-existing drawings or field information, and how reliable was it? (Did you include copies in the field notes?)

Section 6

USING THE COLLECTION

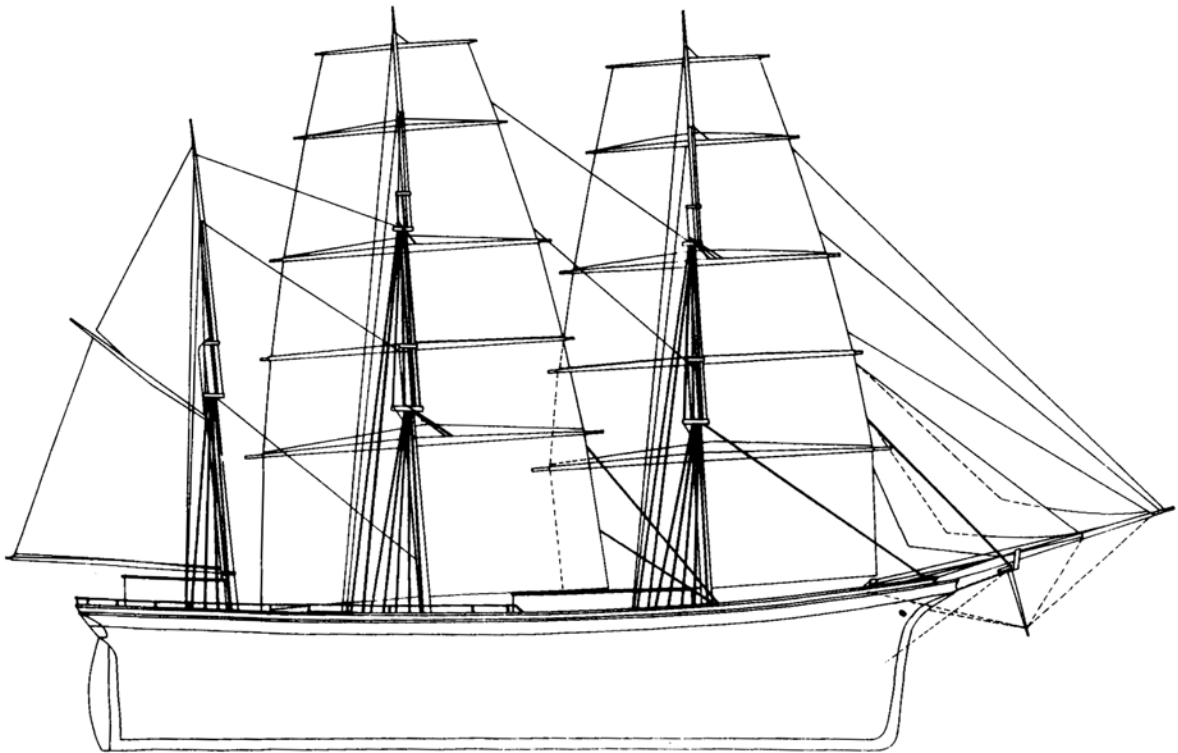

USING THE COLLECTION

The HABS/HAER/HALS collections of the National Park Service are stored and made available through the Library of Congress. Researchers may visit the library or you can simply search the collections online via the web site “Built In America”. The web site allows you to search by name, location, or type.

Digital images of the History, Photos, and Drawings can all be downloaded directly from the site and there is no fee to use them. Below are some samples from a site search.

<http://lcweb2.loc.gov/ammem/hhhtml/>